

Integrated Circuits Solid State Relays

One of the broadest lines of optically isolated Solid State Relays (SSRs) available in a wide range of configurations, blocking voltages, and load currents

Littelfuse OptoMOS® Solid State Relays

PCB Relays



Optically Isolated Power Relays

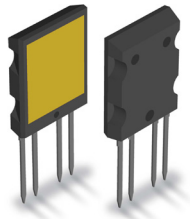

Fault Protected SSRs

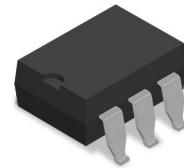

Key Highlights:

- Blocking Voltage from 30 V_p up to 800 V_p
 - Maximum On-resistance as low as 150 mΩ
 - Turn-on/Turn-off switching speeds from 50 μs to 10 ms
 - MOSFET-based AC/DC and DC-only relays
 - Load current from 50 mA_{AC} up to 2.2 A_{AC}
 - 1500 V_{RMS} to 5000 V_{RMS} isolation from input to output
- Blocking voltage up to 1000 V_p
 - On-resistance as low as 50 mΩ
 - Turn-on/Turn-off switching speeds from 1 ms to 25 ms
 - MOSFET-based AC/DC and DC-only relays
 - Load current up to 22.8 A_{DC} (with 5 °C/W heat sink)
 - 2500 V_{RMS} to 5000 V_{RMS} isolation from input to output (or substrate)
- Broadest Line and Most Robust in the Industry
 - **Current Limiting:** Active current limit protection
 - **Thermal Management:** Active temperature shutdown protection

Numerous advantages over Electro Mechanical Relays

- Immune to magnetic fields (security market)
- Higher reliability (no contact pitting)
- No relay contact bounce (smooth switching)
- Uses less board space
- Number of switching cycles does not reduce the lifetime of the Relay
- ...many more

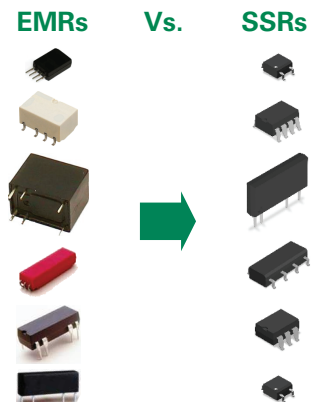

Solid State Relay

30 V to 1000 V load voltage range; 50 mA to 32 A_{DC}¹⁾ load current range

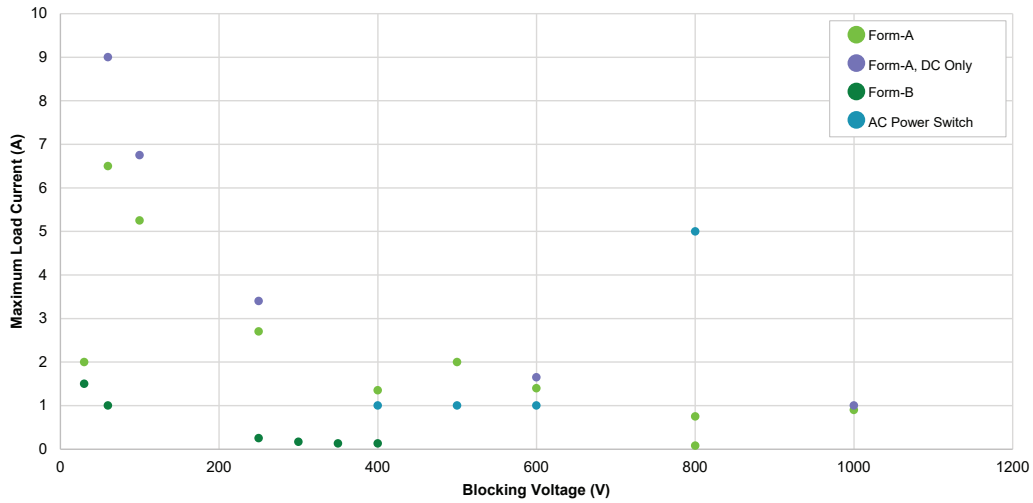

1) Mounted on 5°C/W heat sink

Various package options including power packages

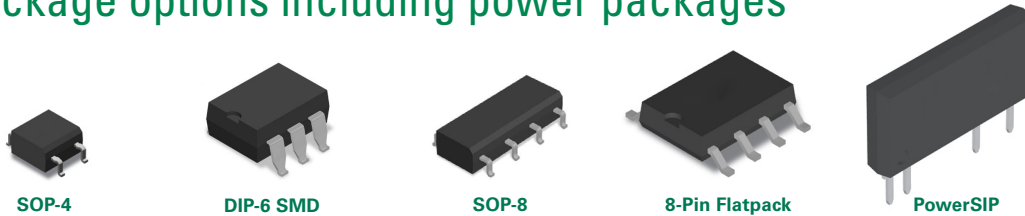

Heat dissipating, isolating ceramic substrate is heat-sink compatible for higher current applications

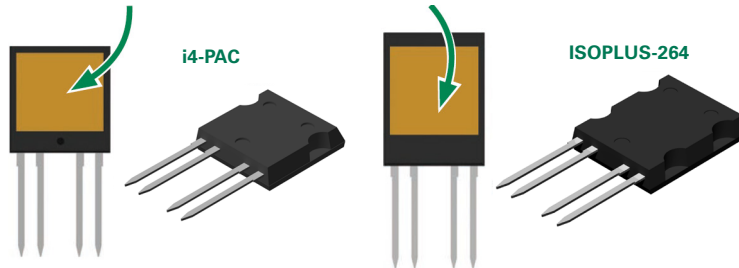

Isolation voltage range from 1500 V_{RMS} to 5000 V_{RMS}

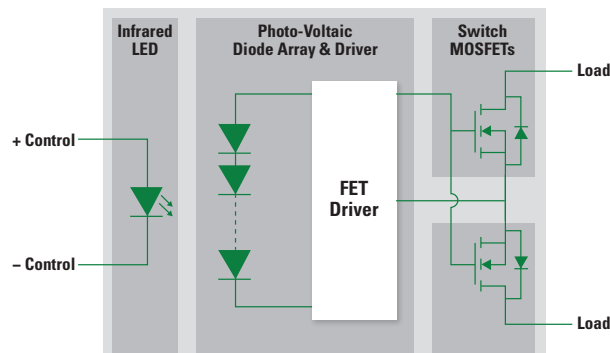

Solid State Relay

Versions with MOSFET and SCR outputs available

MOSFET-based Relay

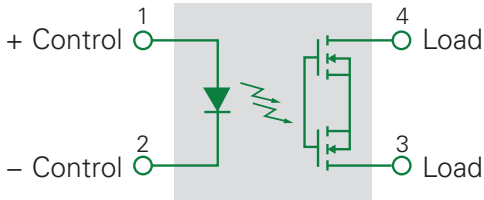

SCR-based Relay

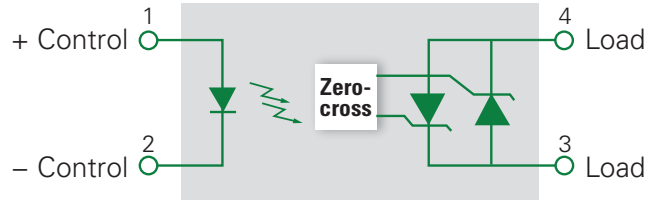

Active Current Limiting SSRs with Voltage Triggered Shutdown and Thermal Management

All of the Fault Protected Solid State Relays (SSR) feature Active Current Limiting and Thermal Management while some Relays (CPC1540, CPC1563, and CPC1593) have additional feature of Voltage Triggered Shutdown, or VTS.

Fault Protected SSRs can directly replace footprint-compatible standard SSRs in existing designs to improve end-product survivability.

These Fault Protected relays resume normal operation upon removal of the fault condition or upon cycling the input control current. Should the fault condition repeat or persist, the fault protection will immediately resume.

Active Current Limiting: All Fault Protected SSRs limit load current to protect both the load and the SSR.

Voltage Triggered Shutdown: CPC1540, CPC1563, and CPC1593 incorporate a third protection feature called Voltage Triggered Shutdown (VTS). During a current limiting event this advanced thermal management protection feature reduces the relay current to $<100 \mu\text{A}$ whenever the voltage drop across the relay exceeds a non-adjustable predetermined threshold thereby preventing excessive heating of the SSR.

Thermal Management: All Fault Protected relays include the traditional thermal management feature that deactivates the SSR outputs anytime the die temperature exceeds a safe limit regardless of the Active Current Limiting state and when equipped, the Voltage Triggered Shutdown state. This feature provides excellent power cross immunity.

Without VTS Protection

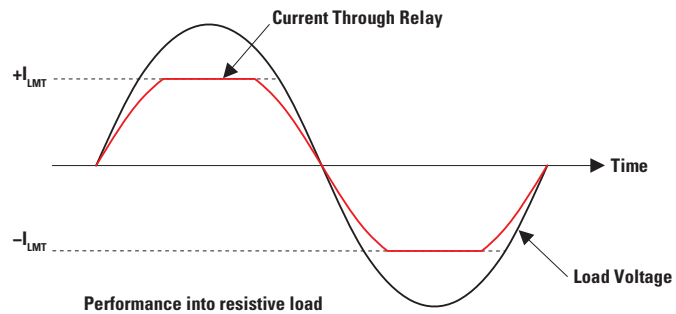
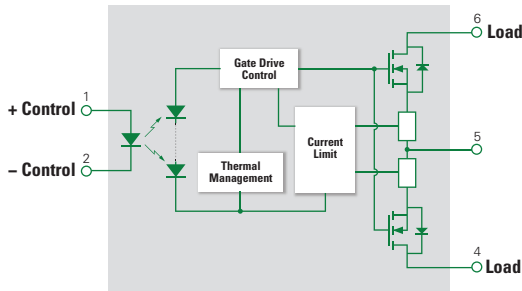

With VTS Protection

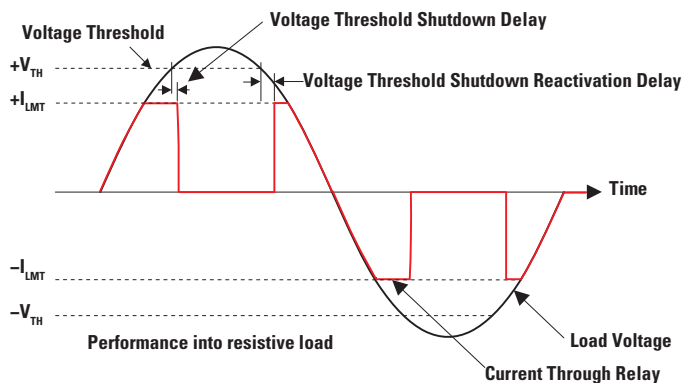
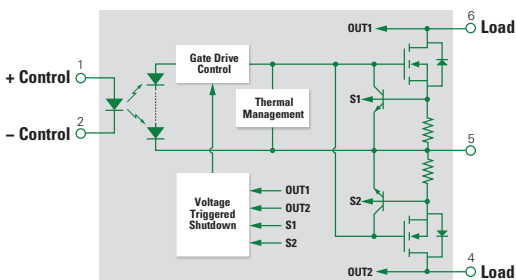

Solid State Relay

Markets for SSRs with MOSFET output (examples)



Building Security



Home Automation



Smart Meter



Telephony Line Switch



Testing & Instrumentation



Solenoid & Valve Control

Typical Application Diagram

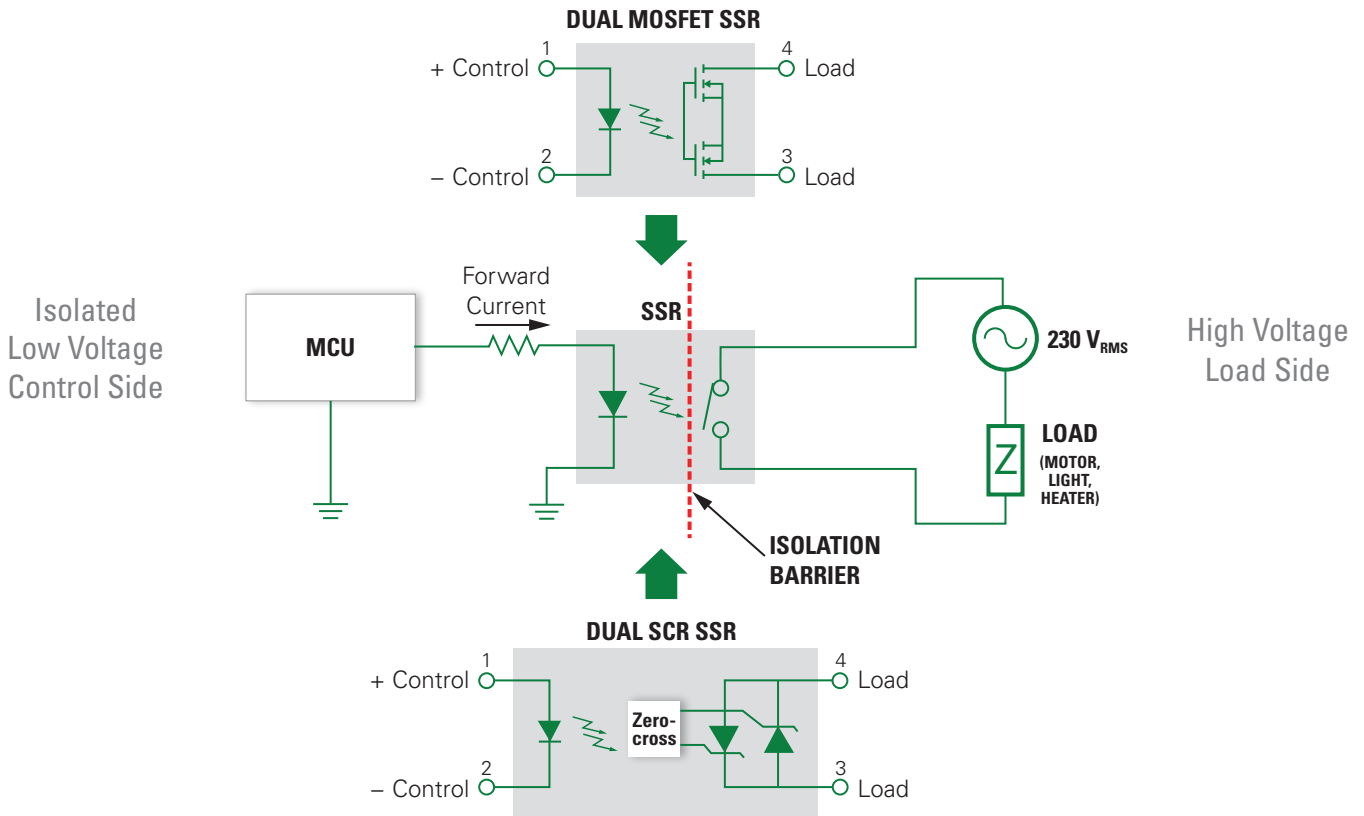

Markets for AC Power Relays with SCR output (examples)



Home Automation



Smart Meter

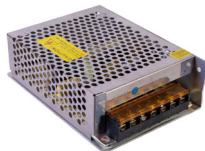

AC Power Supply



Street Lighting



Motor Control (Eg. Fitness Equipment)



Fuel & Chemical Pump