

# TRDU SERIES

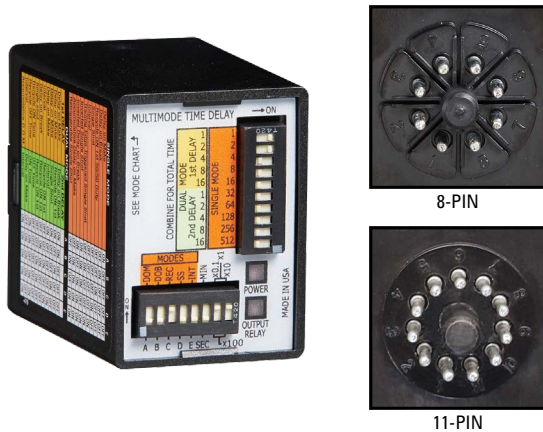

## Description

The TRDU Series is a versatile universal time delay relay with 21 selectable single and dual functions. The dual functions replace up to three timers required to accomplish the same function. Both the function and the timing range are selectable with switches located on the face of the unit. Two LED's indicate input voltage and output status. This device offers full 10A isolated relay output contacts in either SPDT or DPDT. The TRDU replaces hundreds of part numbers, thereby, reducing your stock inventory requirements.

## 21 Functions

Five switches are provided to set one of 10 single or 11 dual modes of operation.

## Features & Benefits

FEATURES	BENEFITS
<b>Multifunction:</b> 21 timing functions	Replace hundreds of parts and reduce stocking requirements
<b>Microcontroller based</b>	Repeat Accuracy + / - 0.1%
<b>User selectable time delay</b>	Timing settings are switch selectable 0.1s - 1,705h in eight ranges for added flexibility
<b>Isolated 10A, SPDT or DPDT output contacts</b>	Allows control of loads for AC or DC voltages
<b>LED indicators</b>	Provides visual indication of input voltage and relay status

## Wiring Diagram

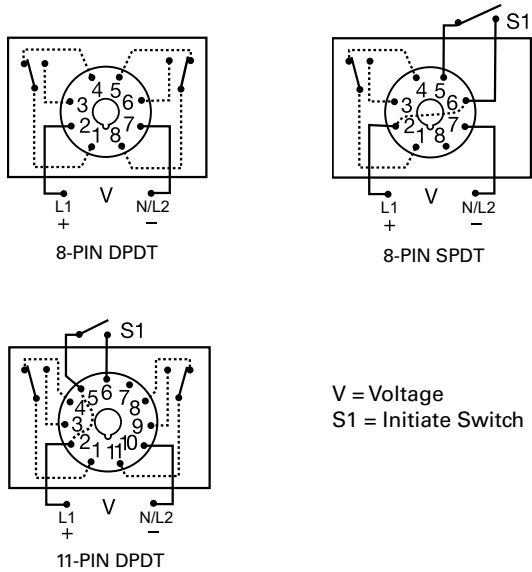

## Accessories



### BZ1 Front Panel Mount Kit

Provides an easy method of through-the-panel mounting of 8- or 11-pin plug-in timers, flashers, and other controls.



### NDS-8 Octal 8-pin Socket

8-pin 35mm DIN rail or surface mount. Surface mounted with two #6 screws or snaps onto a 35 mm DIN rail. Uses PSC8 hold-down clips.



### NDS-11 11-pin Socket

11-pin 35mm DIN rail or surface mount. Surface mounted with two #6 screws or snaps onto a 35 mm DIN rail. Uses PSC11 hold-down clips.



### PSC8 or PSC11 Hold-down Clips

Securely mounts plug-in controls in any position. Provides protection against vibration. Use PSC8 with NDS-8 Octal Socket or PSC11 with NDS-11 Socket. Sold in sets of two.



### C103PM (AL) DIN Rail

35 mm aluminum DIN rail available in a 36 in. (91.4 cm) length.

## Ordering Information

MODEL	INPUT VOLTAGE	BASE CONNECTION
TRDU120A1	120VAC	8-pin, DPDT*
TRDU120A2	120VAC	8-pin, SPDT
TRDU120A3	120VAC	11-pin, DPDT
TRDU12D1	12VDC	8-pin, DPDT*
TRDU12D2	12VDC	8-pin, SPDT
TRDU230A2	230VAC	8-pin, SPDT
TRDU24A1	24VAC/DC	8-pin, DPDT*
TRDU24A2	24VAC/DC	8-pin, SPDT
TRDU24A3	24VAC/DC	11-pin, DPDT

If you don't find the part you need, call us for a custom product 800-843-8848

\*Limited to 9 operating functions in 8-pin DPDT units.



### TRDU SERIES

#### Single Functions

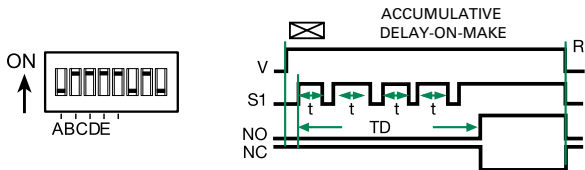
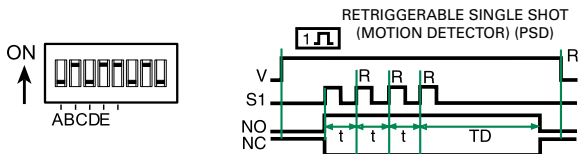
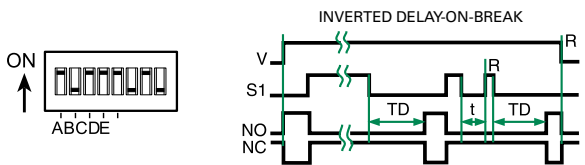
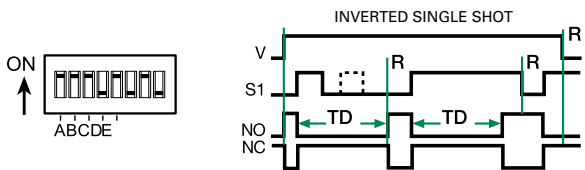
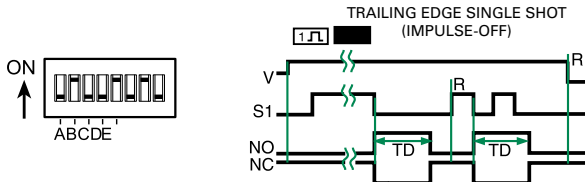
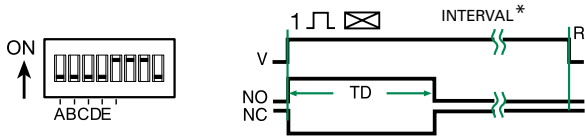

#### Dual Functions

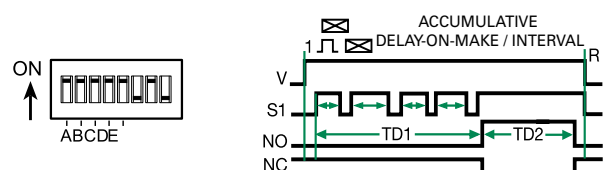
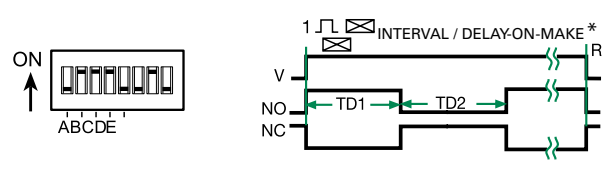
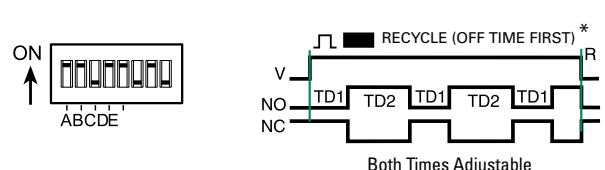
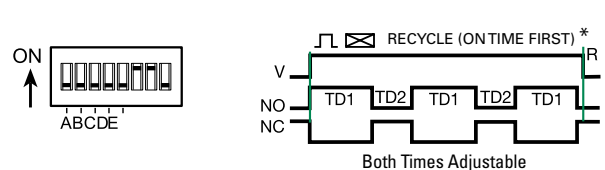
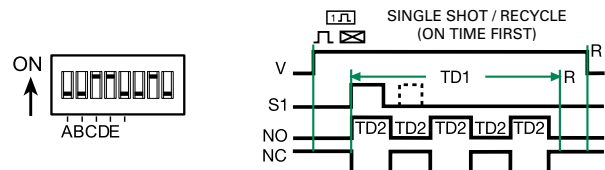
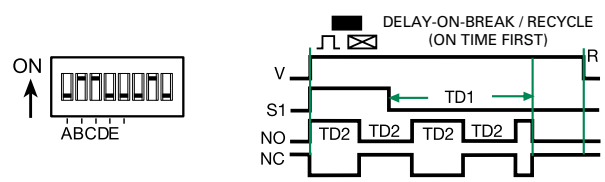
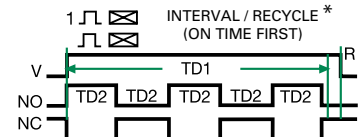

#### KEY

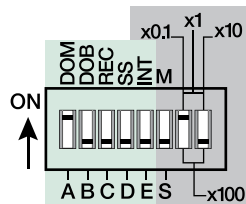

5 Switches for Function Selection  
3 Switches for Time Delay Range

#### LEGEND

V = Voltage  
R = Reset  
S1 = Initiate Switch  
NO = Normally Open Contact  
NC = Normally Closed Contact  
TD, TD1, TD2 = Complete Time Delay  
t = Partial Time Delay  
DOM = Delay-on-Make  
DOB = Delay-on-Break  
REC = Recycle  
SS = Single Shot  
INT = Interval  
M = Minutes  
S = Seconds  
— = Undefined time

\* 9 Functions included in the 8 pin DPDT models

NOTE: The time delay range is the same for both functions when dual functions are selected.