

SMDLCE-HR Series

3000 W Low Capacitance Surface Mount in DO-214AB



Agency Approvals

Agency	Agency File Number
	E230531

Maximum Ratings & Thermal Characteristics ($T_A = 25\text{ }^\circ\text{C}$ unless otherwise noted)

Parameter	Symbol	Value	Unit
Peak Pulse Power Dissipation by 10/1000 μs Waveform (Fig.1)(Note 1)	P_{PPM}	3000	W
Power Dissipation on Infinite Heat Sink at $T_L = 50\text{ }^\circ\text{C}$	P_D	6.5	W
Operating Temperature Range	T_J	-65 to 150	$^\circ\text{C}$
Storage Temperature Range	T_{STG}	-65 to 175	$^\circ\text{C}$

Notes:

1. Non-repetitive current pulse, per Fig. 3 and derated above T_J (initial) = $25\text{ }^\circ\text{C}$ per Fig. 2.

Description

SMDLCE-HR high reliability series is designed specifically to protect sensitive data line electronic equipment from voltage transients induced by lightning and other transient voltage events.

Features

- Low capacitance $\leq 50\text{ pF}$, 3000 W peak pulse power capability at 10/1000 μs waveform, repetition rate (duty cycles):0.01 %
- For surface mounted applications in order to optimize board space
- Low profile package
- Built-in strain relief
- Typical failure mode is short from over-specified voltage or current
- Whisker test is conducted based on JEDEC JESD201A per its table 4a and 4c
- ESD protection of data lines in accordance with IEC 61000-4-2 ESD 30 kV (Air), 30 kV (Contact)
- EFT protection of data lines in accordance with IEC 61000-4-4
- Glass passivated chip junction
- Low incremental surge resistance
- Fast response and excellent clamping capability
- UL recognized compound meeting flammability rating V-0
- Meet MSL level1, per J-STD-020, high temperature soldering guaranteed:260 $^\circ\text{C}/10$ seconds at terminals
- Matte tin lead-free plated
- Halogen free and RoHS compliant
- Pb-free E3 means 2nd level interconnect is Pb-free and the terminal finish material is tin(Sn) (IPC/JEDEC J-STD-609A.01)

Applications

- I/O Interfaces for avionics applications, such as flight control, FADEC, radar, and etc.
- Protection for aircraft fast data line

Schematic

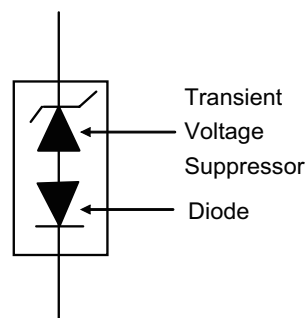

SMDLCE-HR Series

3000 W Low Capacitance Surface Mount in DO-214AB

Electrical Characteristics

Part Number	Marking Code	Stand-Off Voltage V_R (V)	Minimum Breakdown Voltage $V_{BR}(V)$ @ I_T		Test Current I_T (mA)	Maximum Reverse Leakage at I_R @ V_R (μ A)	Maximum Clamping Voltage @ $I_{PP} V_C$ (V)	Maximum Peak Pulse Current per (Fig.3) I_{PP} (A)	Maximum Junction Capacitance at 0 Volts $f = 1$ MHz (pF)	Working Inverse Blocking Voltage V_{WIB} (V)	Inverse Blocking Leakage Current at I_B @ V_{WIB} (mA)	Peak Inverse Blocking Voltage V_{PIB} (V)	Agency Approval 
			Min	Max									
SMDLCE12-HR	SPEE	12.0	13.30	14.70	1	5	20.9	75.4	50	75	1.0	100	X
SMDLCE13-HR	SPEG	13.0	14.40	15.90	1	3	22.5	139.5	50	75	1.0	100	X
SMDLCE14-HR	SPEK	14.0	15.60	17.20	1	3	24.2	129.3	50	75	1.0	100	X
SMDLCE15-HR	SPEM	15.0	16.70	18.50	1	1	25.4	123.0	50	75	1.0	100	X
SMDLCE16-HR	SPEP	16.0	17.80	19.70	1	1	27.0	115.4	50	75	1.0	100	X
SMDLCE17-HR	SPER	17.0	18.90	20.90	1	1	28.6	108.7	50	75	1.0	100	X
SMDLCE18-HR	SPET	18.0	20.00	22.10	1	1	30.2	102.7	50	75	1.0	100	X
SMDLCE20-HR	SPEV	20.0	22.20	24.50	1	1	33.4	92.6	50	75	1.0	100	X
SMDLCE22-HR	SPEX	22.0	24.40	26.90	1	1	36.5	84.5	50	75	1.0	100	X
SMDLCE24-HR	SPEZ	24.0	26.70	29.50	1	1	39.9	77.1	50	75	1.0	100	X
SMDLCE26-HR	SPFE	26.0	28.90	31.90	1	1	43.1	71.3	50	75	1.0	100	X
SMDLCE28-HR	SPFG	28.0	31.10	34.40	1	1	46.5	66.1	50	75	1.0	100	X
SMDLCE30-HR	SPFK	30.0	33.30	36.80	1	1	49.4	62.0	50	75	1.0	100	X
SMDLCE33-HR	SPFM	33.0	36.70	40.60	1	1	53.3	56.3	50	75	1.0	100	X
SMDLCE36-HR	SPFP	36.0	40.00	44.20	1	1	58.1	51.6	50	75	1.0	100	X
SMDLCE40-HR	SPFR	40.0	44.40	49.10	1	1	64.5	46.5	50	75	1.0	100	X
SMDLCE43-HR	SPFT	43.0	47.80	52.80	1	1	69.4	43.2	50	75	1.0	100	X
SMDLCE45-HR	SPFV	45.0	50.00	55.30	1	1	72.7	41.3	50	75	1.0	100	X
SMDLCE48-HR	SPFX	48.0	53.30	58.90	1	1	77.4	38.8	50	75	1.0	100	X
SMDLCE51-HR	SPFZ	51.0	56.70	62.70	1	1	82.4	36.4	50	75	1.0	100	X
SMDLCE54-HR	SRGE	54.0	60.00	66.30	1	1	87.1	34.4	50	100	1.0	125	X
SMDLCE58-HR	SPGG	58.0	64.40	71.20	1	1	93.6	32.1	50	100	1.0	125	X
SMDLCE60-HR	SPGK	60.0	66.70	73.70	1	1	96.8	31.0	50	100	1.0	125	X
SMDLCE64-HR	SPGM	64.0	71.10	78.60	1	1	103.0	29.1	50	100	1.0	125	X
SMDLCE70-HR	SPGP	70.0	77.80	86.00	1	1	113.0	26.5	50	125	1.0	150	X

Note: Each lot of parts will pass group B test requirement.

Screen Process

100 % vision inspection	MIL-STD-750 method 2074
100 % X-RAY inspection	MIL-STD-750 method 2076
100 % temperature cycle test (-55 °C to 150 °C, 20 cycles, dwell time 15 min)	MIL-STD-750 method 1051
100 % reflow (2x)	JEDEC J-STD-020
100 % surge test (2x)	MIL-STD-750 method 4066
100 % HTRB 150 °C bias = V_R (80 % breakdown voltage, 96 hrs)	MIL-STD-750 method 1038
Final electrical test (100 % 3 sigma limit, 100 % dynamic test and PAT limit)	MIL-STD-750 method 4016.4021.4011

Note: Up-screen program can be specified by customer's request by contacting Littelfuse customer service

SMDLCE-HR Series

3000 W Low Capacitance Surface Mount in DO-214AB

Group B Test Requirement

Screen	Method	Condition	Requirement
Surge test	10/1000 μ s peak pulse waveform	Maximum clamping voltage (V_C) @ peak pulse current (I_{PP})	Sample size 45 perform 10x Accept 0 failures
Burn-in (HTRB)	MIL -STD-750, method 1038.5	Applied voltage 100 % V_R @150 °C	Sample size 45 340 hours Accept 0 failures
Electrical test	..	I_R @ V_R , $V_{(BR)}$ @ I_T	Sample size 45 Accept 0 failures

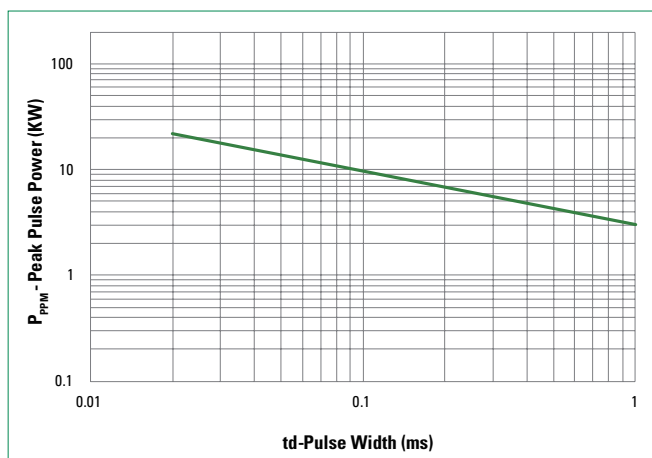
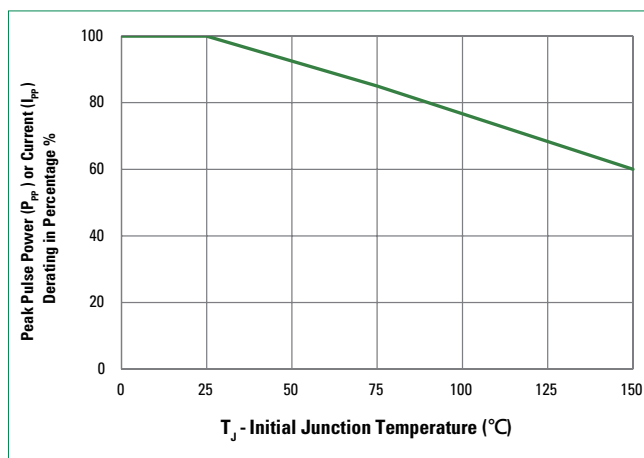
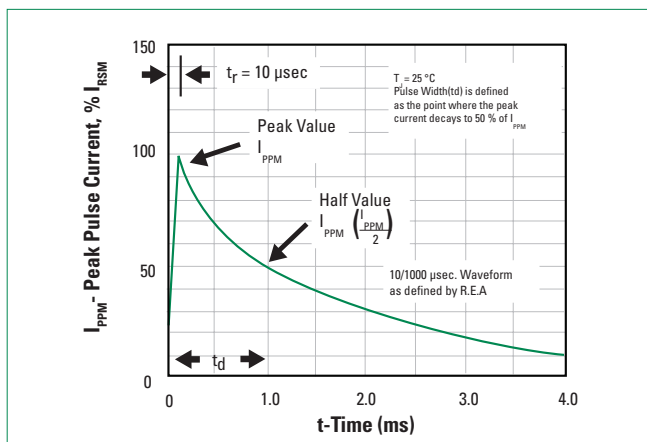
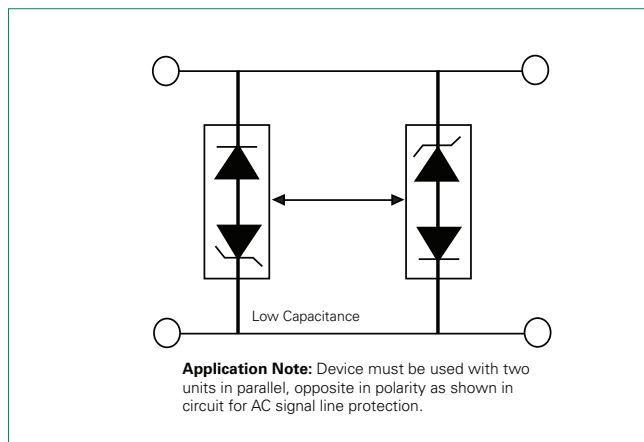
Ratings and Characteristic Curves ($T_A = 25\text{ }^\circ\text{C}$ unless otherwise noted)**Figure 1 - Peak Pulse Power Rating Curve****Figure 2 - Peak Pulse Power Derating Curve****Figure 3 - Pulse Waveform****Figure 4 - AC Line Protection Application**

SMDLCE-HR Series

3000 W Low Capacitance Surface Mount in DO-214AB

Soldering Parameters

Reflow Condition		Lead-free assembly
Pre Heat	- Temperature Min ($T_{s(min)}$)	150 °C
	- Temperature Max ($T_{s(max)}$)	200 °C
	- Time (min to max) (t_s)	60 – 180 seconds
Average Ramp Up Rate (Liquidus Temp (T_L) to Peak)		3 °C/second max
$T_{s(max)}$ to T_L - Ramp-up Rate		3 °C/second max
Reflow	- Temperature (T_L) (Liquidus)	217 °C
	- Time (min to max) (t_s)	60 – 150 seconds
Peak Temperature (T_p)		260 ^{+0/-5} °C
Time Within 5 °C of Actual Peak Temperature (t_p)		20 – 40 seconds
Ramp-down Rate		6 °C/second max
Time 25 °C to Peak Temperature (T_p)		8 minutes max
Do Not Exceed		260 °C

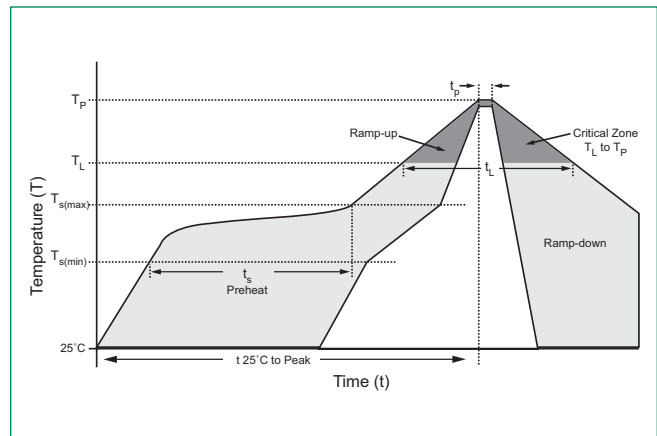

Physical Specifications

Weight	0.003oz., 0.093g
Case	JEDEC DO-214AB molded plastic body over glass passivated junction.
Polarity	Color band denotes cathode except bidirectional
Terminal	Matte Tin-plated leads. Solderable per JESD22-B102

Environmental Specifications

High Temperature Storage	JESD22-A103
HTRB	JESD22-A108
Temperature Cycling	JESD22-A104
MSL	JEDEC-J-STD-020, Level 1
H3TRB	JESD22-A101
RSH	JESD22-A111

Dimensions

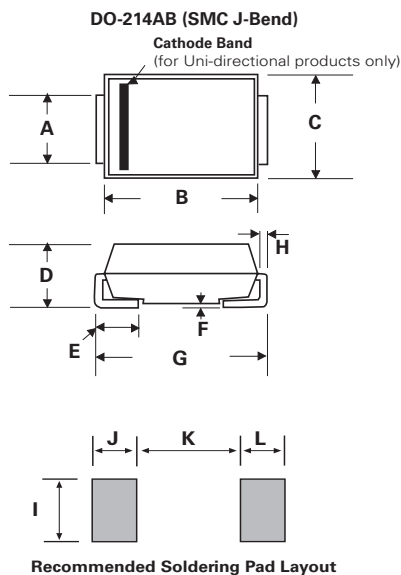

Dimensions	Inches		Millimeters	
	Min	Max	Min	Max
A	0.114	0.126	2.900	3.200
B	0.260	0.280	6.600	7.110
C	0.220	0.245	5.590	6.220
D	0.079	0.103	2.060	2.620
E	0.030	0.060	0.760	1.520
F	-	0.008	-	0.203
G	0.305	0.320	7.750	8.130
H	0.006	0.012	0.152	0.305
I	0.129	-	3.300	-
J	0.094	-	2.400	-
K	-	0.165	-	4.200
L	0.094	-	2.400	-

SMDLCE-HR Series

3000 W Low Capacitance Surface Mount in DO-214AB

Part Numbering System

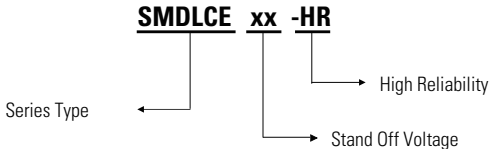

Part Marking System

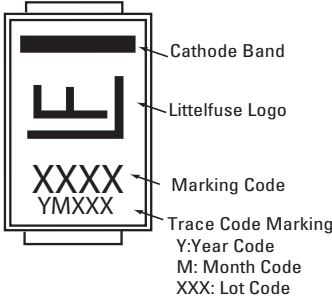

Packaging

Part number	Component Package	Quantity	Packaging Option	Packaging Specification
SMDLCE-HR	DO-214AB	500	Tape & Reel - 16 mm tape/7" reel	EIA STD RS-481

Tape and Reel Specification

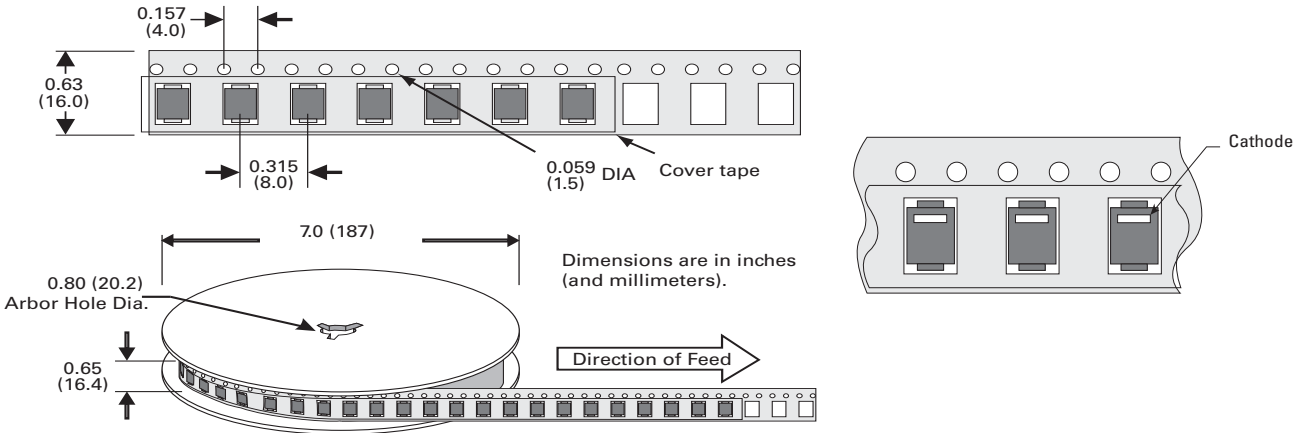

SMDLCE-HR Series

3000 W Low Capacitance Surface Mount in DO-214AB

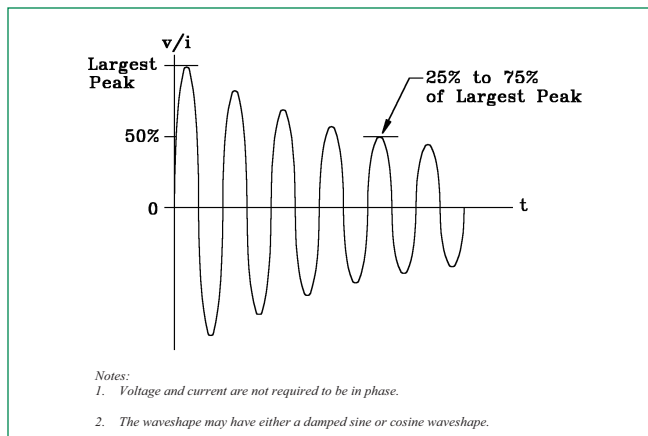
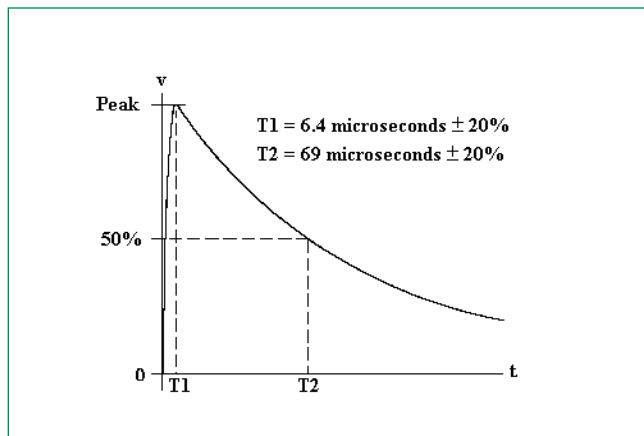
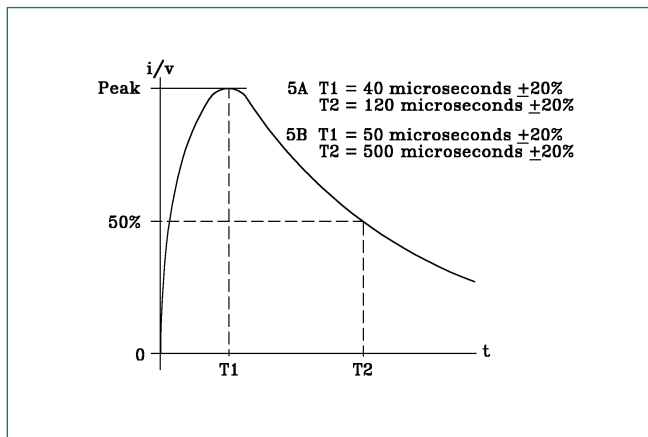
RTCA/DO-160G Wave 3**RTCA/DO-160G Wave 4****RTCA/DO-160G Wave 5**

SMDLCE-HR Series

3000 W Low Capacitance Surface Mount in DO-214AB

Pin Injection Protection Per RTCA/DO-160G

Part Number	25 °C						70 °C						120 °C					
	Wave 3	Wave 4 (6.4/69 μs)			Wave 5a (40/120 μs)		Wave 3	Wave 4 (6.4/69 μs)			Wave 5a (40/120 μs)		Wave 3	Wave 4 (6.4/69 μs)			Wave 5a (40/120 μs)	
	L5	L3	L4	L5	L3	L4	L5	L3	L4	L5	L3	L4	L5	L3	L4	L5	L3	L4
	128A	60A	150A	320A	300A	750A	128A	60A	150A	320A	300A	750A	128A	60A	150A	320A	300A	750A
SMDLCE12-HR	pass	pass	pass	pass	pass	-	pass	pass	pass	pass	pass	-	pass	pass	pass	pass	-	-
SMDLCE13-HR	pass	pass	pass	pass	pass	-	pass	pass	pass	pass	pass	-	pass	pass	pass	pass	-	-
SMDLCE14-HR	pass	pass	pass	pass	pass	-	pass	pass	pass	pass	pass	-	pass	pass	pass	pass	-	-
SMDLCE15-HR	pass	pass	pass	pass	pass	-	pass	pass	pass	pass	pass	-	pass	pass	pass	pass	-	-
SMDLCE16-HR	pass	pass	pass	pass	pass	-	pass	pass	pass	pass	-	-	pass	pass	pass	-	-	-
SMDLCE17-HR	pass	pass	pass	pass	pass	-	pass	pass	pass	pass	-	-	pass	pass	pass	-	-	-
SMDLCE18-HR	pass	pass	pass	pass	pass	-	pass	pass	pass	pass	-	-	pass	pass	pass	-	-	-
SMDLCE20-HR	pass	pass	pass	pass	pass	-	pass	pass	pass	pass	-	-	pass	pass	pass	-	-	-
SMDLCE22-HR	pass	pass	pass	-	-	-	pass	pass	pass	-	-	-	pass	pass	pass	-	-	-
SMDLCE24-HR	pass	pass	pass	-	-	-	pass	pass	pass	-	-	-	pass	pass	pass	-	-	-
SMDLCE26-HR	pass	pass	pass	-	-	-	pass	pass	pass	-	-	-	pass	pass	pass	-	-	-
SMDLCE28-HR	pass	pass	pass	-	-	-	pass	pass	pass	-	-	-	pass	pass	pass	-	-	-
SMDLCE30-HR	pass	pass	pass	-	-	-	pass	pass	pass	-	-	-	pass	pass	pass	-	-	-
SMDLCE33-HR	pass	pass	pass	-	-	-	pass	pass	pass	-	-	-	pass	pass	pass	-	-	-
SMDLCE36-HR	pass	pass	pass	-	-	-	pass	pass	pass	-	-	-	pass	pass	pass	-	-	-
SMDLCE40-HR	pass	pass	pass	-	-	-	pass	pass	pass	-	-	-	pass	pass	pass	-	-	-
SMDLCE43-HR	pass	pass	pass	-	-	-	pass	pass	pass	-	-	-	pass	pass	-	-	-	-
SMDLCE45-HR	pass	pass	pass	-	-	-	pass	pass	-	-	-	-	pass	pass	-	-	-	-
SMDLCE48-HR	pass	pass	pass	-	-	-	pass	pass	-	-	-	-	pass	pass	-	-	-	-
SMDLCE51-HR	pass	pass	pass	-	-	-	pass	pass	-	-	-	-	pass	pass	-	-	-	-
SMDLCE54-HR	pass	pass	pass	-	-	-	pass	pass	-	-	-	-	pass	pass	-	-	-	-
SMDLCE58-HR	pass	pass	-	-	-	-	pass	pass	-	-	-	-	pass	pass	-	-	-	-
SMDLCE60-HR	pass	pass	-	-	-	-	pass	pass	-	-	-	-	pass	pass	-	-	-	-
SMDLCE64-HR	pass	pass	-	-	-	-	pass	pass	-	-	-	-	pass	-	-	-	-	-
SMDLCE70-HR	pass	pass	-	-	-	-	pass	pass	-	-	-	-	pass	-	-	-	-	-

Note:

1. L1 = Level 1, L2 = Level 2, L3 = Level 3, L4 = Level 4, L5 = Level 5