

# SLVU2.8 Series

## 2.8V 40A TVS Array

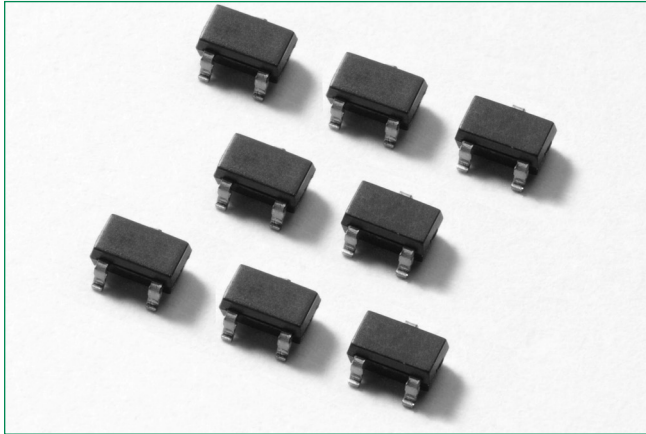

### Additional Information



Resources



Accessories



Samples

### Pinout

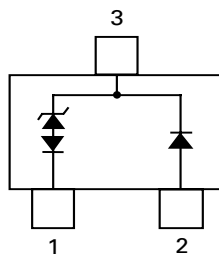

### Functional Block Diagram

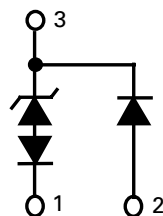

### Description

The SLVU2.8 series was designed to protect low voltage, CMOS devices from ESD and lightning induced transients. There is a compensating diode in parallel with the low voltage TVS to protect one unidirectional line or a high speed data pair when two devices are paired together. These robust structures can safely absorb repetitive ESD strikes at  $\pm 30\text{kV}$  (contact discharge) per the IEC 61000-4-2 standard and each structure can safely dissipate up to 40A (IEC 61000-4-5,  $t_P=8/20\mu\text{s}$ ) with very low clamping voltages.

### Features

- ESD, IEC 61000-4-2,  $\pm 30\text{kV}$  contact,  $\pm 30\text{kV}$  air
- EFT, IEC 61000-4-4, 40A (5/50ns)
- Lightning, IEC 61000-4-5, 2nd edition 40A (8/20 $\mu\text{s}$ )
- Low capacitance of 2pF per line (Pin 2 to 1)
- Low leakage current of 1 $\mu\text{A}$  (MAX) at 2.8V
- Small SOT23-3 (JEDEC TO-236) package saves board space
- RoHS compliant and lead-free

### Applications

- 10/100/1000 Ethernet
- WAN/LAN Equipment
- Switching Systems
- Desktops, Servers, and Notebooks
- Analog Inputs
- Base Stations
- Security Systems
- Surveillance Cameras

### Application Example

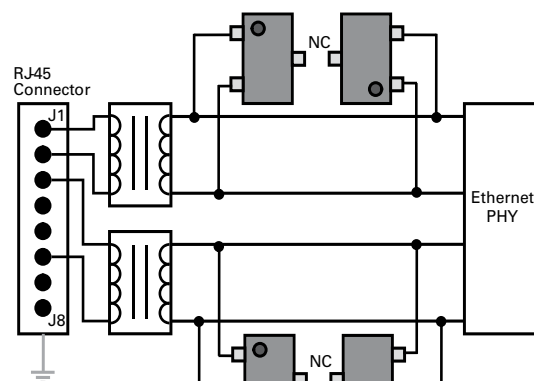

# SLVU2.8 Series

## 2.8V 40A TVS Array

### Electrical Characteristics ( $T_{OP} = 25^{\circ}\text{C}$ )

Parameter	Symbol	Test Conditions	Min	Typ	Max	Units
Reverse Standoff Voltage	$V_{RWM}$	$I_R \leq 1\mu\text{A}$			2.8	V
Reverse Breakdown Voltage	$V_{BR}$	$I_T = 2\mu\text{A}$	3.0			V
Snap Back Voltage	$V_{SB}$	$I_T = 50\text{mA}$	2.8			V
Reverse Leakage Current	$I_{LEAK}$	$V_R = 2.8\text{V}$ (Pin 2 or 3 to 1)			1	$\mu\text{A}$
Clamping Voltage <sup>1</sup>	$V_C$	$I_{PP} = 5\text{A}$ , $t_p = 8/20\mu\text{s}$ (Pin 3 to 1)		5.7	7.0	V
Clamping Voltage <sup>1</sup>		$I_{PP} = 24\text{A}$ , $t_p = 8/20\mu\text{s}$ (Pin 3 to 1)		8.3	12.5	V
Clamping Voltage <sup>1</sup>		$I_{PP} = 5\text{A}$ , $t_p = 8/20\mu\text{s}$ (Pin 2 to 1)		7.0	8.5	V
Clamping Voltage <sup>1</sup>		$I_{PP} = 24\text{A}$ , $t_p = 8/20\mu\text{s}$ (Pin 2 to 1)		13.9	15.0	V
Dynamic Resistance	$R_{DYN}$	$(V_{C2} - V_{C1}) / (I_{PP2} - I_{PP1})$ (Pin 2 to 1)		0.4		$\Omega$
ESD Withstand Voltage <sup>1</sup>	$V_{ESD}$	IEC61000-4-2 (Contact)	$\pm 30$			kV
		IEC61000-4-2 (Air)	$\pm 30$			kV
Diode Capacitance <sup>1</sup>	$C_D$	$V_R = 0\text{V}$ , $f = 1\text{MHz}$ (Pin 2 to 1)		2.0	2.5	pF

**Note:** <sup>1</sup>Parameter is guaranteed by design and/or device characterization.

### Absolute Maximum Ratings

Parameter	Rating	Units
Peak Pulse Power ( $t_p = 8/20\mu\text{s}$ )	600	W
Peak Pulse Current ( $t_p = 8/20\mu\text{s}$ )	40	A
Operating Temperature	-40 to 125	$^{\circ}\text{C}$
Storage Temperature	-55 to 150	$^{\circ}\text{C}$

**Caution:** Stresses above those listed in "Absolute Maximum Ratings" may cause permanent damage to the device. This is a stress only rating and operation of the device at these or any other conditions above those indicated in the operational sections of this specification is not implied.

**Figure 1: Capacitance vs. Reverse Voltage**

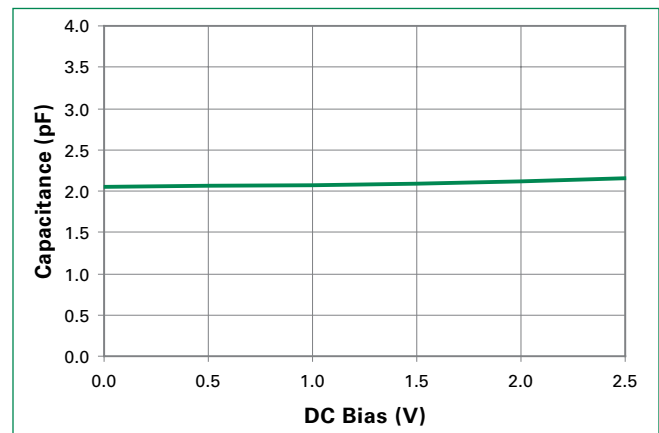

**Figure 2: Clamping Voltage vs. IPP**

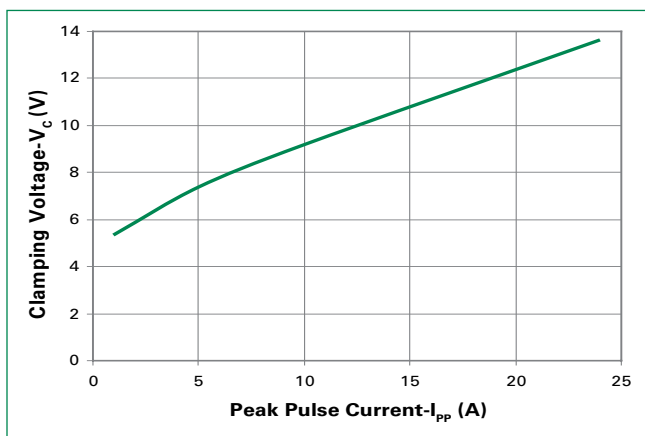

**Figure 3: Pulse Waveform**

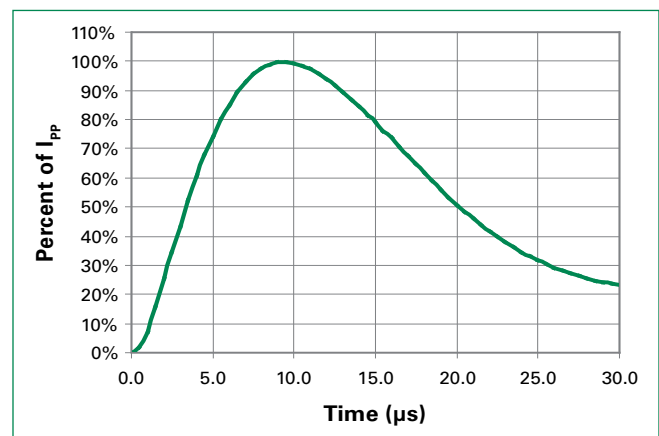

# SLVU2.8 Series

## 2.8V 40A TVS Array

### Application Example Detail

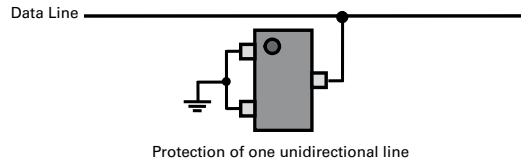

Protection of one unidirectional data line is realized by connecting pin 3 to the protected line, and pins 1 and 2 to GND. In this configuration, the device presents a maximum loading capacitance of tens of picofarads. During positive transients, the internal TVS diode will conduct and steer current from pin 3 to 1 (GND), clamping the data line at or below the specified voltages for the device (see Electrical Characteristics section). For negative transients, the internal compensating diode is forward biased, steering the current from pin 2 (GND) to 3.

Low capacitance protection of a high-speed data pair is realized by

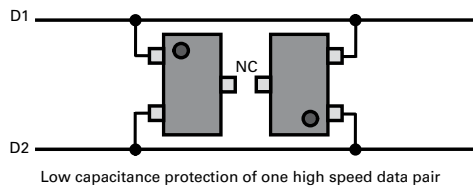

connecting two devices in antiparallel. As shown, pin 1 of the first device is connected to D1 and pin 2 is connected to D2. Additionally, pin 2 of the second device is connected to D1 and pin 1 is connected to D2. Pin 3 must be NC (or not connected) for both devices. When the potential on D1 exceeds the potential on D2 (by the rated standoff voltage), pin 2 on the second device will steer current into pin 1. The compensating diode will conduct in the forward direction steering current into the avalanching TVS diode which is operating in the reverse direction. For the opposite transient, the first device will behave in the same manner. In this two device arrangement, the total loading capacitance is two times the rated capacitance from pin 2 to pin 1 which will typically be much less than 10pF making it suitable for high-speed data pair such as 10/100/1000 Ethernet.

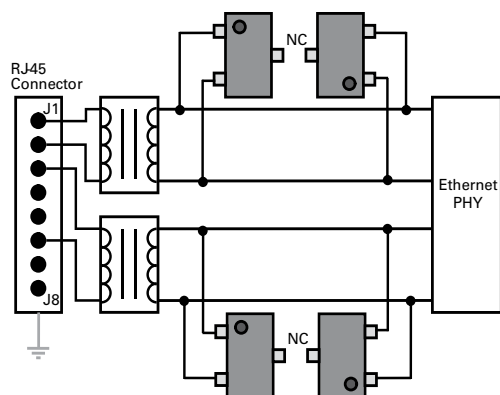

### Product Characteristics

<b>Lead Plating</b>	Matte Tin
<b>Lead Material</b>	Copper Alloy
<b>Lead Coplanarity</b>	0.0004 inches (0.102mm)
<b>Substitute Material</b>	Silicon
<b>Body Material</b>	Molded Epoxy
<b>Flammability</b>	UL Recognized molded epoxy compound meeting flammability rating V-0

#### Notes:

- All dimensions are in millimeters
- Dimensions include solder plating.
- Dimensions are exclusive of mold flash & metal burr.
- Blo is facing up for mold and facing down for trim/form, i.e. reverse trim/form.
- Package surface matte finish VDI 11-13.

### Soldering Parameters

<b>Reflow Condition</b>	Pb – Free assembly	
<b>Pre Heat</b>	- Temperature Min ( $T_{s(min)}$ )	150°C
	- Temperature Max ( $T_{s(max)}$ )	200°C
	- Time (min to max) ( $t_s$ )	60 – 120 secs
<b>Average ramp up rate (Liquidus) Temp (<math>T_L</math>) to peak</b>	3°C/second max	
<b><math>T_{s(max)}</math> to <math>T_L</math> - Ramp-up Rate</b>	3°C/second max	
<b>Reflow</b>	- Temperature ( $T_L$ ) (Liquidus)	217°C
	- Temperature ( $t_r$ )	60 – 150 seconds
<b>Peak Temperature (<math>T_p</math>)</b>	260 <sup>+0/-5</sup> °C	
<b>Time within 5°C of actual peak Temperature (<math>t_p</math>)</b>	30 seconds	
<b>Ramp-down Rate</b>	6°C/second max	
<b>Time 25°C to peak Temperature (<math>T_p</math>)</b>	8 minutes Max.	
<b>Do not exceed</b>	260°C	

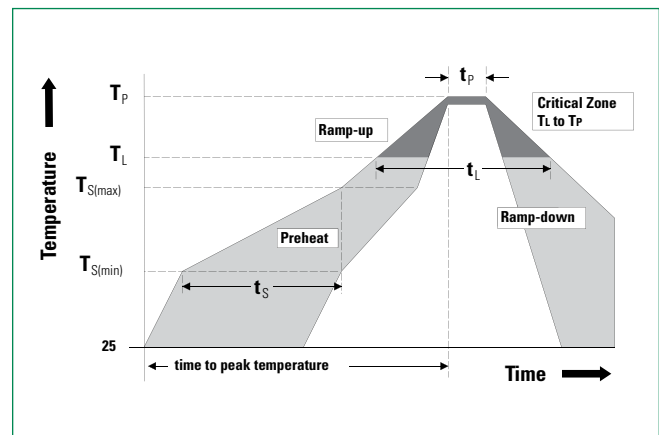

# SLVU2.8 Series

## 2.8V 40A TVS Array

### Package Dimensions – SOT-23

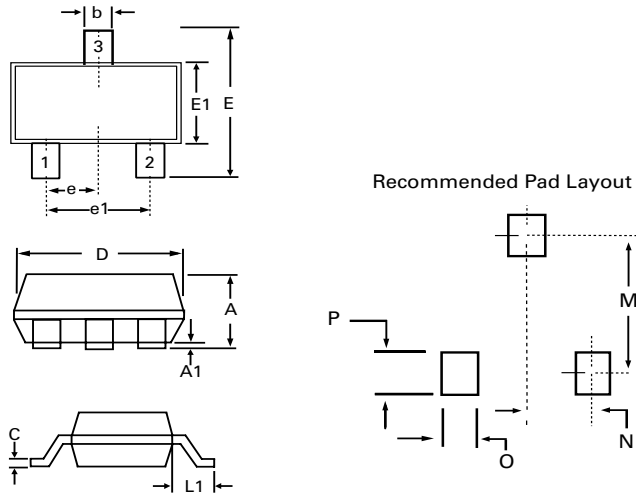

Package	SOT23-3			
Pins	3			
JEDEC	TO-236			
	Millimetres		Inches	
	Min	Max	Min	Max
<b>A</b>	0.89	1.12	0.035	0.044
<b>A1</b>	0.01	0.1	0.0004	0.004
<b>b</b>	0.3	0.5	0.012	0.020
<b>c</b>	0.08	0.2	0.003	0.008
<b>D</b>	2.8	3.04	0.110	0.120
<b>E</b>	2.1	2.64	0.083	0.104
<b>E1</b>	1.2	1.4	0.047	0.055
<b>e</b>	0.95 BSC		0.038 BSC	
<b>e1</b>	1.90 BSC		0.075 BSC	
<b>L1</b>	0.54 REF		0.021 REF	
<b>M</b>		2.29		.90
<b>N</b>		0.95		0.038
<b>O</b>		0.78		0.30 TYP
<b>P</b>		0.78		0.30 TYP

### Part Numbering System

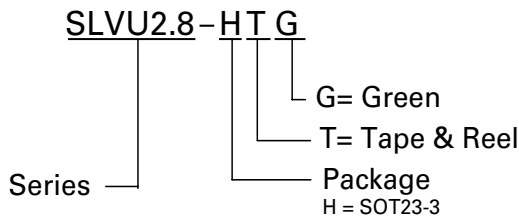

### Part Marking System

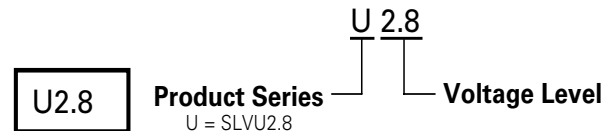

### Ordering Information

Part Number	Package	Marking	Min. Order Qty.
SLVU2.8HTG	SOT23-3	U2.8	3000

### Embossed Carrier Tape & Reel Specification – SOT23-3 Package

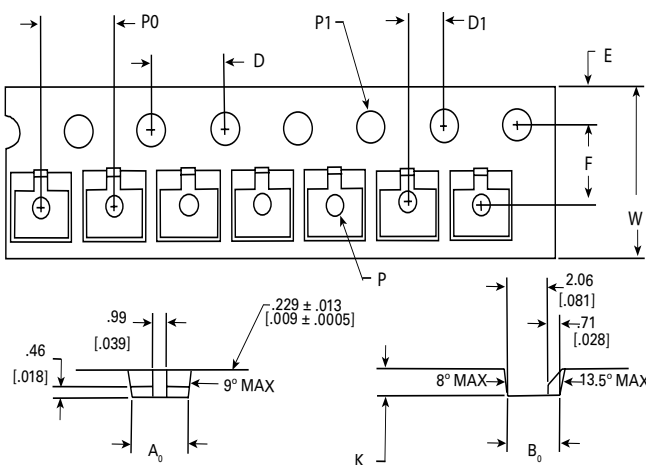

Symbol	Millimetres		Inches	
	Min	Max	Min	Max
<b>A0</b>	3.05	3.25	0.12	0.128
<b>B0</b>	2.67	2.87	0.105	0.113
<b>D</b>	3.9	4.1	0.153	0.161
<b>D1</b>	1.95	2.05	0.788	0.792
<b>E</b>	1.65	1.85	0.065	0.073
<b>F</b>	3.45	3.55	0.136	0.14
<b>K0</b>	1.12	1.32	0.476	0.484
<b>P</b>	0.95	1.05	0.037	0.041
<b>P0</b>	3.9	4.1	0.153	0.161
<b>P1</b>		1.6		0.063
<b>W</b>	7.9	8.3	0.311	0.327

**Disclaimer Notice** - Information furnished is believed to be accurate and reliable. However, users should independently evaluate the suitability of and test each product selected for their own applications. Littelfuse products are not designed for, and may not be used in, all applications. Read complete Disclaimer Notice at <http://www.littelfuse.com/disclaimer-electronics>.