

LGD8205ATI 350 V, 20 A N-Channel Ignition IGBT

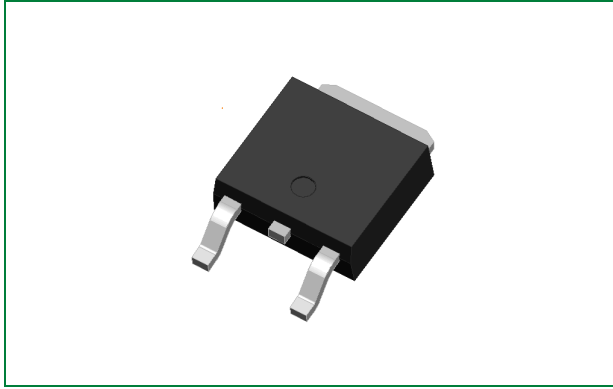

Agency Approvals

Environmental Approvals



Circuit Diagram

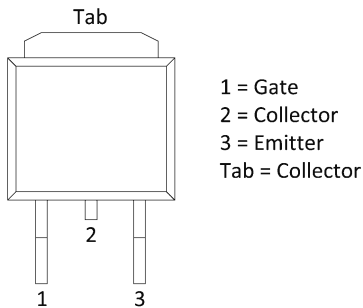

Functional Diagram

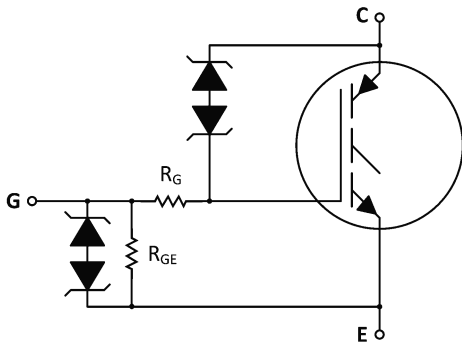

Product Summary

Characteristic	Value	Unit
V_{CES}	350	V
I_C	20	A

Description

This Logic Level Insulated Gate Bipolar Transistor (IGBT) features monolithic circuitry integrating ESD and Over-Voltage clamped protection for use in inductive coil driver applications. Primary uses include Ignition, Direct Fuel Injection, or wherever high voltage and high current switching is required.

Features

- Ideal for Coil-on-Plug and Driver-on-Coil Applications
- DPAK Package Offers Smaller Footprint for Increased Board Space
- Gate-Emitter ESD Protection
- Temperature Compensated Gate-Collector Voltage Clamp Limits Stress Applied to Load
- Integrated ESD Diode Protection
- Low Threshold Voltage Interfaces Power Loads to Logic or Microprocessor Devices
- Low Saturation Voltage
- High Pulsed Current Capability
- Optional Gate Resistor (R_G) and Gate-Emitter Resistor (R_{GE})
- AEC-Q101 Qualified
- These are Pb-Free Devices

1. Maximum Ratings ($T_J = 25\text{ }^\circ\text{C}$ unless otherwise specified)	3
2. Unclamped Collector-to-Emitter Avalanche Characteristics	3
3. Thermal Characteristics	3
4. Electrical Characteristics – Off	4
5. Electrical Characteristics – On	4
6. Dynamic Characteristics	5
7. Switching Characteristics	5
8. Figure Data	6
9. Package Dimensions	9
10. Part Numbering and Marking	9
11. Packing Options	9

1. Maximum Ratings ($T_J = 25^\circ\text{C}$ unless otherwise specified)

Characteristic	Conditions	Symbol	Value	Unit
Collector-Emitter Voltage	-	V_{CES}	390	V_{DC}
Gate-Gate Voltage	-	V_{CER}	390	V_{DC}
Gate-Emitter Voltage	-	V_{GE}	± 15	V_{DC}
Collector Current – Continuous		I_C	20	A_{DC}
Collector Current – Pulsed	$T_C = 25^\circ\text{C}$		50	A_{AC}
Continuous Gate Current	-	I_G	1.0	mA
Transient Gate Current	$t \leq 2 \text{ ms}, f \leq 100 \text{ Hz}$		20	mA
ESD – Charged Device Model	-	ESD	2.0	kV
ESD – Human Body Model	$R = 1500 \Omega, C = 100 \text{ pF}$		8.0	kV
ESD – Machine Model	$R = 0 \Omega, C = 200 \text{ pF}$		400	V
Total Power Dissipation	$T_C = 25^\circ\text{C}$	P_D	125	W
	Derating for $> 25^\circ\text{C}$		0.83	$\text{W}/^\circ\text{C}$
Operating and Storage Temperature Range	-	T_J, T_{stg}	-55 to +175	$^\circ\text{C}$

2. Unclamped Collector-to-Emitter Avalanche Characteristics

Characteristic	Symbol	Value	Unit
Single Pulse Collector-to-Emitter Avalanche Energy			
$V_{CC} = 50 \text{ V}, V_{GE} = 5.0 \text{ V}, P_{kL} = 16.7 \text{ A}, R_G = 1000 \Omega, L = 1.8 \text{ mH}, \text{ Starting } T_J = 25^\circ\text{C}$	E_{AS}	250	mJ
$V_{CC} = 50 \text{ V}, V_{GE} = 5.0 \text{ V}, P_{kL} = 14.9 \text{ A}, R_G = 1000 \Omega, L = 1.8 \text{ mH}, \text{ Starting } T_J = 150^\circ\text{C}$		200	
$V_{CC} = 50 \text{ V}, V_{GE} = 5.0 \text{ V}, P_{kL} = 14.1 \text{ A}, R_G = 1000 \Omega, L = 1.8 \text{ mH}, \text{ Starting } T_J = 175^\circ\text{C}$		180	
Reverse Avalanche Energy			
$V_{CC} = 100 \text{ V}, V_{GE} = 20 \text{ V}, P_{kL} = 25.8 \text{ A}, L = 6.0 \text{ mH}, \text{ Starting } T_J = 25^\circ\text{C}$	$E_{AS(R)}$	2000	mJ

Note: $-55^\circ\text{C} \leq T_J \leq 175^\circ\text{C}$

3. Thermal Characteristics

Characteristic	Symbol	Value	Unit
Thermal Resistance, Junction to Case	$R_{\theta JC}$	1.2	$^\circ\text{C}/\text{W}$
Thermal Resistance, Junction to Ambient (DPAK) ¹	$R_{\theta JA}$	95	$^\circ\text{C}/\text{W}$
Maximum Lead Temperature for Soldering Purposes, 1/8" from case for 5 seconds	T_L	275	$^\circ\text{C}$

Footnote 1: When surface mounted to an FR4 board using the minimum recommended pad size

4. Electrical Characteristics – Off

Characteristic	Symbol	Conditions	Temperature	Value			Unit
				Min	Typ	Max	
Collector-Emitter Clamp Voltage	BV_{CES}	$I_C = 2.0 \text{ mA}$	$T_J = -40^\circ\text{C to } 175^\circ\text{C}$	325	350	375	V
		$I_C = 10 \text{ mA}$		340	365	390	
Zero Gate Voltage Collector Current	I_{CES}	$V_{CE} = 15 \text{ V}, V_{GE} = 0 \text{ V}$	$T_J = 25^\circ\text{C}$	-	0.1	1.0	μA
			$T_J = 175^\circ\text{C}$	0.5	1.5	10	
		$V_{CE} = 175 \text{ V}, V_{GE} = 0 \text{ V}$	$T_J = 175^\circ\text{C}$	1.0	25	100 ²	
			$T_J = -40^\circ\text{C}$	0.4	0.8	5.0	
Reverse Collector-Emitter Leakage Current	$I_{CES(R)}$	$V_{CE} = -24 \text{ V}$	$T_J = 25^\circ\text{C}$	0.05	0.25	1.0	mA
			$T_J = 175^\circ\text{C}$	1.0	12.5	25	
			$T_J = -40^\circ\text{C}$	-	0.03	0.25	
Reverse Collector-Emitter Clamp Voltage	$BV_{CES(R)}$	$I_C = -75 \text{ mA}$	$T_J = 25^\circ\text{C}$	30	35	39	V
			$T_J = 175^\circ\text{C}$	35	39	45 ²	
			$T_J = -40^\circ\text{C}$	30	33	37	
Gate-Emitter Clamp Voltage	BV_{GES}	$I_G = \pm 5.0 \text{ mA}$	$T_J = -40^\circ\text{C to } 175^\circ\text{C}$	12	12.5	14	V
Gate-Emitter Leakage Current	I_{GES}	$V_{GE} = \pm 5.0 \text{ V}$	$T_J = -40^\circ\text{C to } 175^\circ\text{C}$	200	300	350 ²	μA
Gate Resistor	R_G	-	$T_J = -40^\circ\text{C to } 175^\circ\text{C}$	-	70	-	Ω
Gate-Emitter Resistor	R_{GE}	-	$T_J = -40^\circ\text{C to } 150^\circ\text{C}$	14.25	16	25	k Ω

Footnote 2: Maximum value of characteristic across temperature range

5. Electrical Characteristics – On

Characteristic	Symbol	Conditions	Temperature	Value			Unit
				Min	Typ	Max	
Gate Threshold Voltage	$V_{GE(th)}$	$I_C = 1.0 \text{ mA}, V_{GE} = V_{CE}$	$T_J = 25^\circ\text{C}$	1.5	1.8	2.1	V
			$T_J = 175^\circ\text{C}$	0.7	1.0	1.3	
			$T_J = -40^\circ\text{C}$	1.7	2.0	2.3 ²	
Threshold Temperature Coefficient (Negative)	-	-	-	3.8	4.6	6.0	mV/ $^\circ\text{C}$
Collector-Emitter On-Voltage ³	$V_{CE(on)}$	$I_C = 6.5 \text{ A}, V_{GE} = 3.7 \text{ V}$	$T_J = 25^\circ\text{C}$	0.95	1.15	1.35	V
			$T_J = 175^\circ\text{C}$	0.7	0.95	1.15	
			$T_J = -40^\circ\text{C}$	1.0	1.3	1.4	
		$I_C = 9.0 \text{ A}, V_{GE} = 3.9 \text{ V}$	$T_J = 25^\circ\text{C}$	0.95	1.25	1.45	
			$T_J = 175^\circ\text{C}$	0.8	1.05	1.25	
			$T_J = -40^\circ\text{C}$	1.1	1.4	1.5	
		$I_C = 7.5 \text{ A}, V_{GE} = 4.5 \text{ V}$	$T_J = 25^\circ\text{C}$	0.85	1.15	1.4	
			$T_J = 175^\circ\text{C}$	0.7	0.95	1.2	
			$T_J = -40^\circ\text{C}$	1.0	1.3	1.6 ²	
		$I_C = 10 \text{ A}, V_{GE} = 4.5 \text{ V}$	$T_J = 25^\circ\text{C}$	1.0	1.3	1.6	
			$T_J = 175^\circ\text{C}$	0.8	1.05	1.4	
			$T_J = -40^\circ\text{C}$	1.1	1.4	1.7 ²	
		$I_C = 15 \text{ A}, V_{GE} = 4.5 \text{ V}$	$T_J = 25^\circ\text{C}$	1.15	1.45	1.7	
			$T_J = 175^\circ\text{C}$	1.0	1.3	1.55	
			$T_J = -40^\circ\text{C}$	1.25	1.55	1.8 ²	
$I_C = 20 \text{ A}, V_{GE} = 4.5 \text{ V}$	$T_J = 25^\circ\text{C}$	1.3	1.6	1.9			
	$T_J = 175^\circ\text{C}$	1.2	1.5	1.8			
	$T_J = -40^\circ\text{C}$	1.4	1.75	2.0 ²			
Forward Transconductance	gfs	$V_{CE} = 5.0 \text{ V}, I_C = 6.0 \text{ A}$	$T_J = 25^\circ\text{C}$	10	18	25	Mhos

Footnote 2: Maximum value of characteristic across temperature range

Footnote 3: Pulse Test: Pulse Width $\leq 300 \mu\text{s}$, Duty Cycle $\leq 2\%$

6. Dynamic Characteristics

Characteristic	Symbol	Conditions	Temperature	Value			Unit
				Min	Typ	Max	
Input Capacitance	C_{ISS}	$V_{CE} = 25 \text{ V}$, $f = 10 \text{ kHz}$	$T_J = 25 \text{ }^\circ\text{C}$	1100	1300	1500	μF
Output Capacitance	C_{OSS}			70	80	90	
Transfer Capacitance	C_{RSS}			18	20	22	

7. Switching Characteristics

Characteristic	Symbol	Conditions	Temperature	Value			Unit
				Min	Typ	Max	
Turn-off Delay Time (Resistive)	$t_{d(off)}$	$V_{CC} = 300 \text{ V}$, $I_C = 9.0 \text{ A}$, $R_G = 1.0 \text{ k}\Omega$, $R_L = 33 \Omega$, $V_{GE} = 5.0 \text{ V}$	$T_J = 25 \text{ }^\circ\text{C}$	6.0	8.0	10	μs
			$T_J = 175 \text{ }^\circ\text{C}$	6.0	8.0	10	
Fall Time (Resistive)	t_f		$T_J = 25 \text{ }^\circ\text{C}$	4.0	6.0	8.0	μs
			$T_J = 175 \text{ }^\circ\text{C}$	8.0	10.5	14	
Turn-off Delay Time (Inductive)	$t_{d(off)}$	$V_{CC} = 300 \text{ V}$, $I_C = 9.0 \text{ A}$, $R_G = 1.0 \text{ k}\Omega$, $L = 300 \mu\text{H}$, $V_{GE} = 5.0 \text{ V}$	$T_J = 25 \text{ }^\circ\text{C}$	3.0	5.0	7.0	μs
			$T_J = 175 \text{ }^\circ\text{C}$	5.0	7.0	9.0	
Fall Time (Inductive)	t_f		$T_J = 25 \text{ }^\circ\text{C}$	1.5	3.0	4.5	μs
			$T_J = 175 \text{ }^\circ\text{C}$	5.0	7.0	10	
Turn-on Delay Time	$t_{d(on)}$	$V_{CC} = 14 \text{ V}$, $I_C = 9.0 \text{ A}$, $R_G = 1.0 \text{ k}\Omega$, $R_L = 1.5 \Omega$, $V_{GE} = 5.0 \text{ V}$	$T_J = 25 \text{ }^\circ\text{C}$	1.0	1.5	2.0	μs
			$T_J = 175 \text{ }^\circ\text{C}$	1.0	1.5	2.0	
Rise Time	t_r		$T_J = 25 \text{ }^\circ\text{C}$	4.0	6.0	8.0	μs
			$T_J = 175 \text{ }^\circ\text{C}$	3.0	5.0	7.0	

8. Figure Data

Figure 1. Self-Clamped Inductive Switching

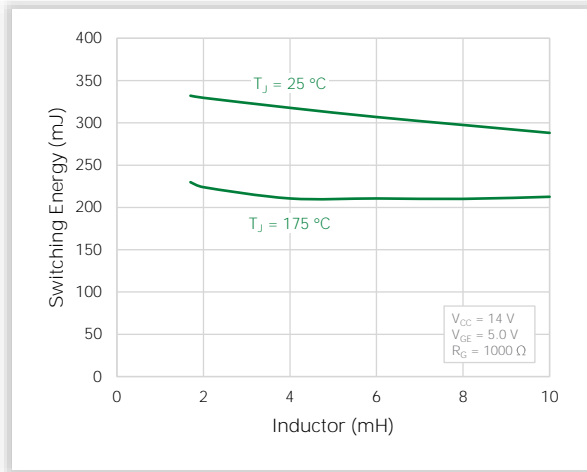

Figure 2. Open Secondary Avalanche Current vs. Temperature

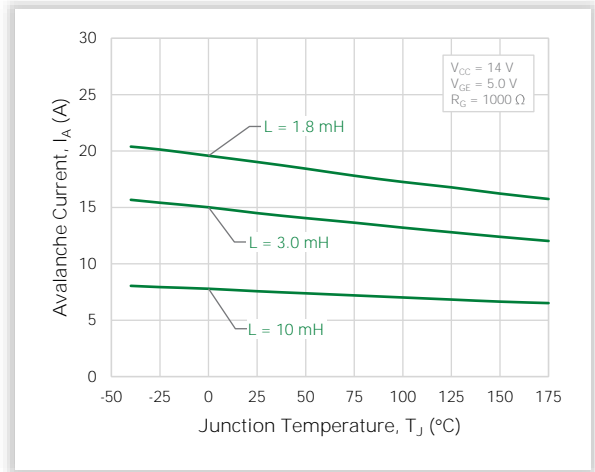

Figure 3. Collector-Emitter Voltage vs. Junction Temperature

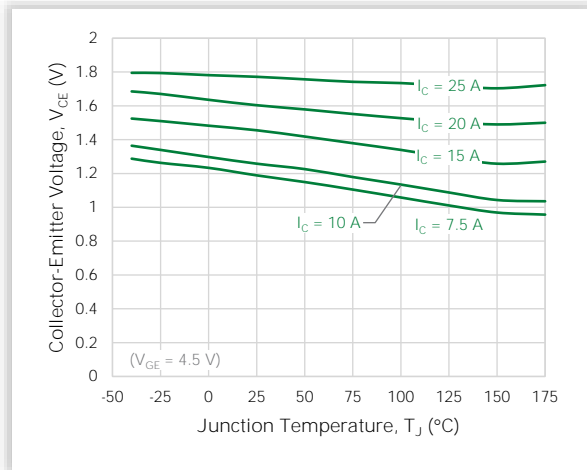

Figure 4. Output Characteristics ($T_J = 175\text{ °C}$)

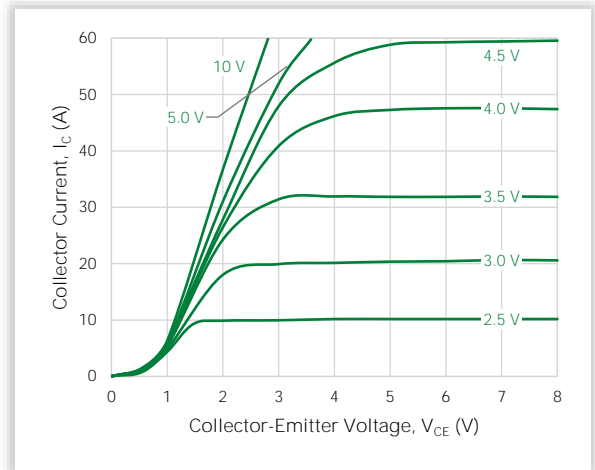

Figure 5. Output Characteristics ($T_J = 25\text{ °C}$)

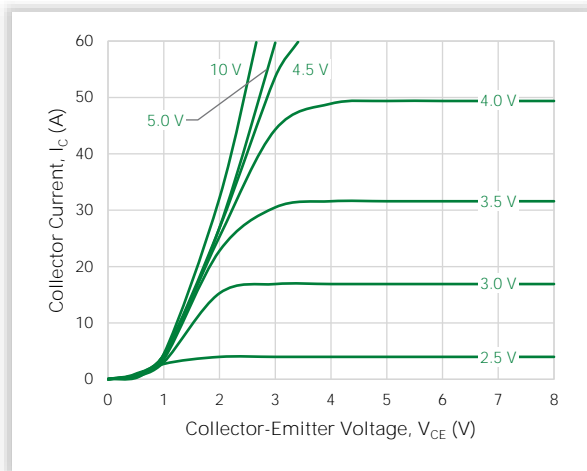

Figure 6. Output Characteristics ($T_J = -40\text{ °C}$)

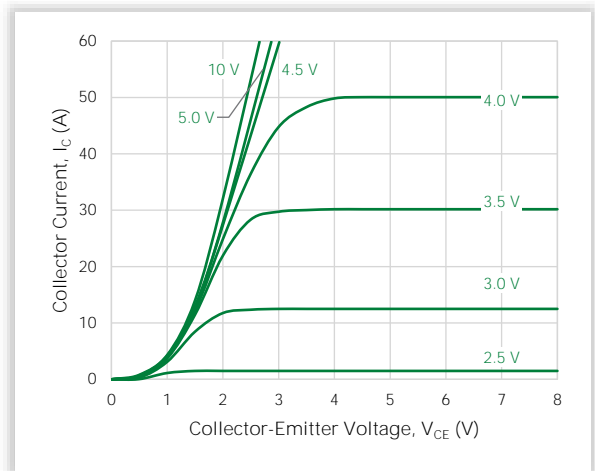

Figure 7. Transfer Characteristics

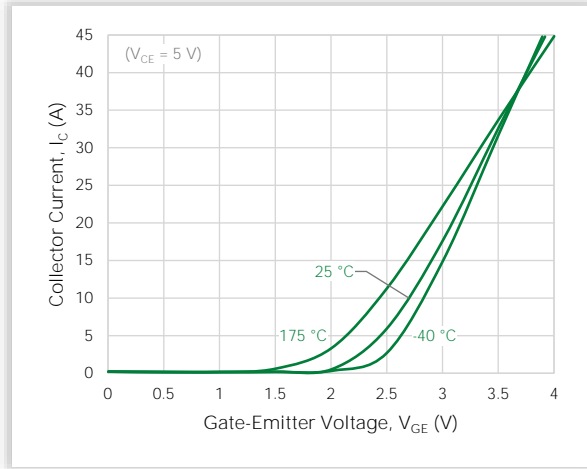

Figure 8. Collector-Emitter Leakage Current vs. Temperature

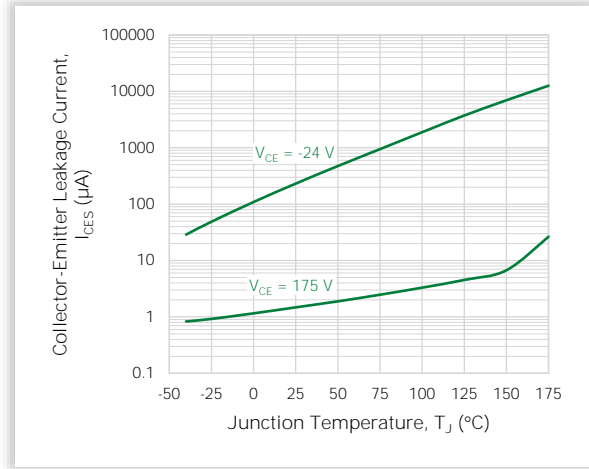

Figure 9. Gate Threshold Voltage vs. Temperature

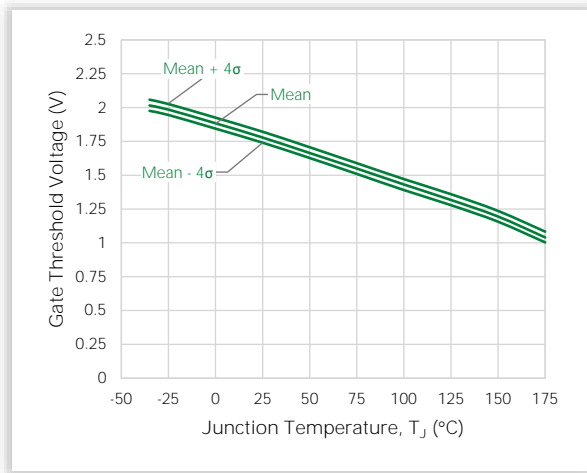

Figure 10. Capacitance Variance

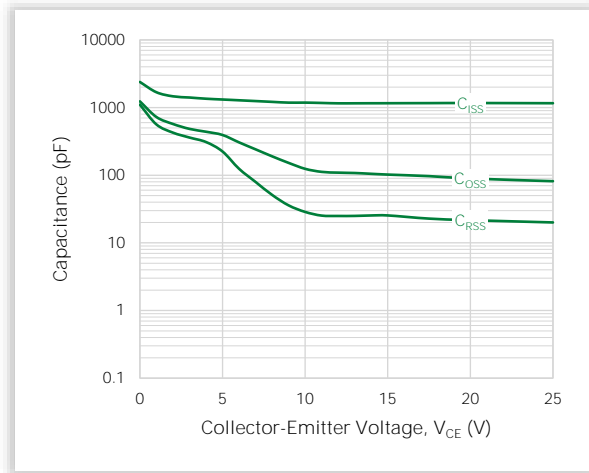

Figure 11. Resistive Switching Fall Time vs. Temperature

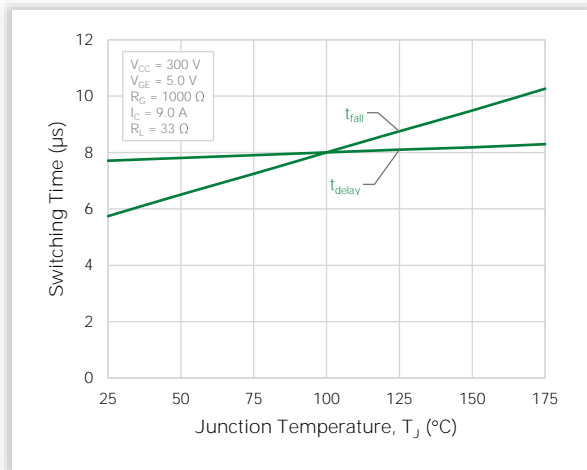

Figure 12. Inductive Switching Fall Time vs. Temperature

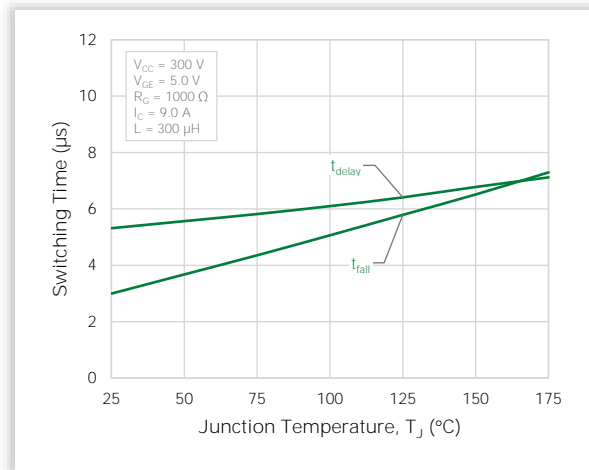

Figure 13. Minimum Pad Transient Thermal Resistance
(Non-normalized Junction-Ambient)

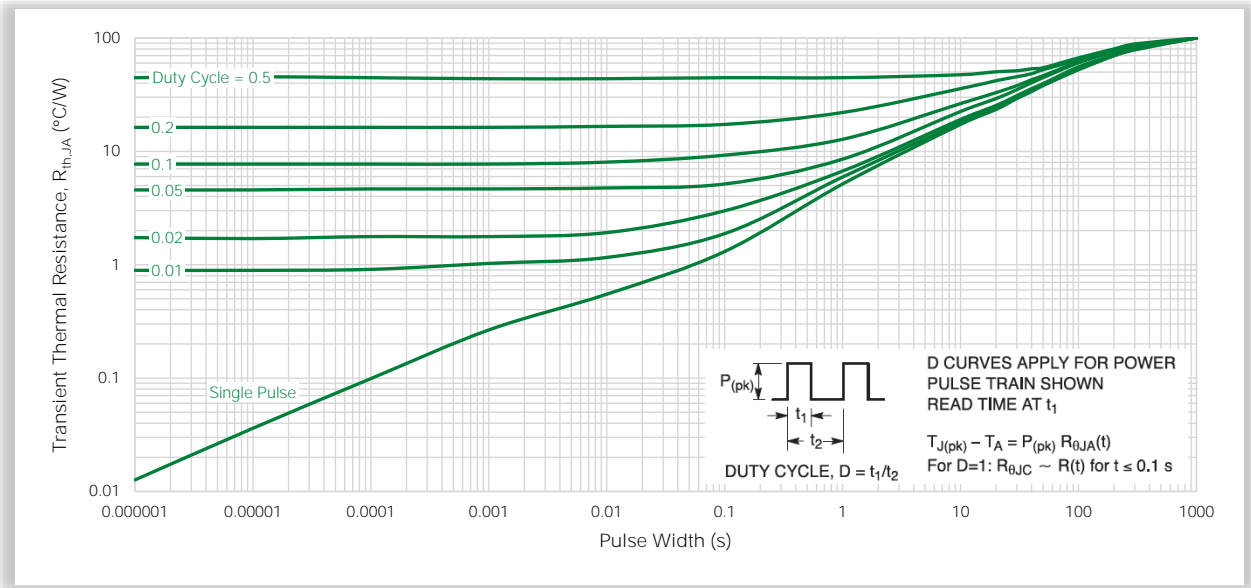
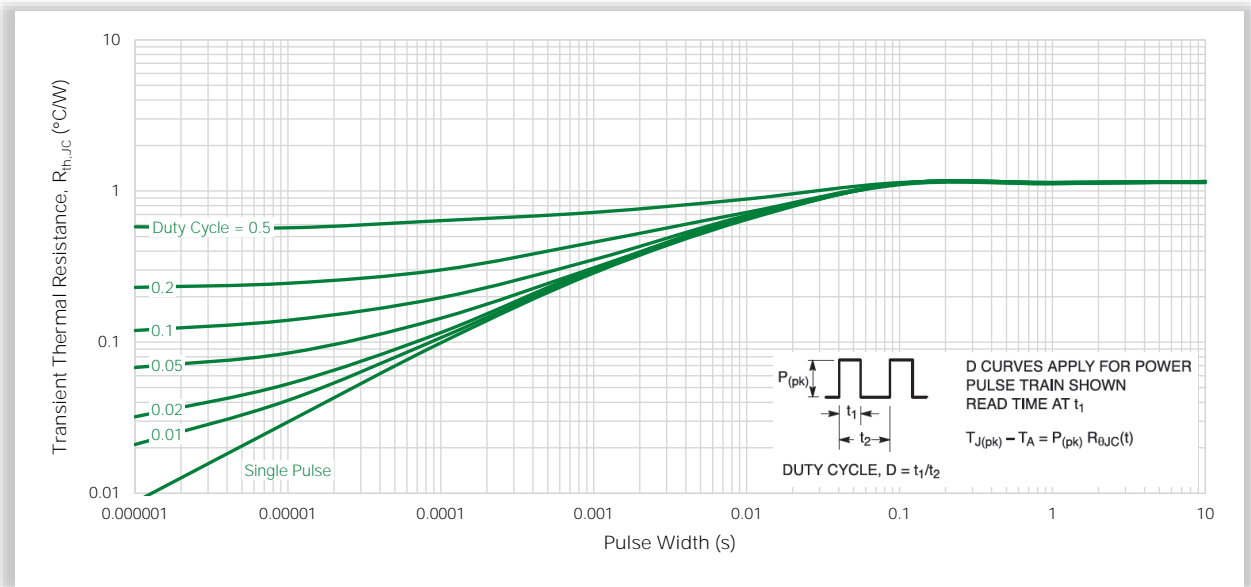
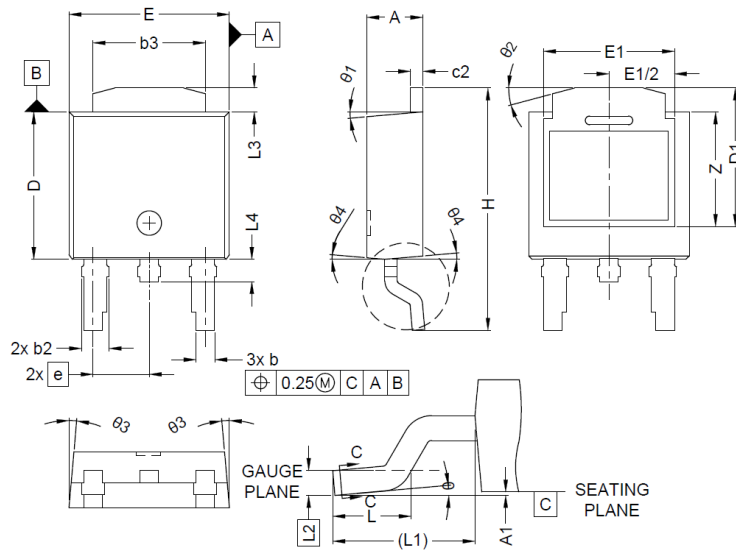

Figure 14. Best Case Transient Thermal Resistance
(Non-normalized Junction-Case mounted on cold plate)



9. Package Dimensions



Recommended Solder Pad Layout:

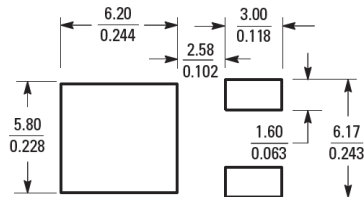

Notes:

1. DIMENSIONING & TOLERANCEING CONFIRM TO ASME Y14.5M-1994.
2. ALL DIMENSIONS ARE IN MILLIMETERS. ANGLES ARE IN DEGREES.
3. HEAT SINK SIDE FLASH IS MAX. 0.8mm.
4. RADIUS ON TERMINAL IS OPTIONAL.

Symbol	Millimeters		
	Min	Nom	Max
A	2.18	-	2.38
A1	0.00	-	0.13
b	0.63	-	0.89
b2	0.72	-	1.14
b3	4.57	-	5.46
c	0.46	-	0.61
c2	0.46	-	0.61
D	5.97	-	6.22
D1	5.45	-	5.85
E	6.35	-	6.73
E1	5.14	-	5.54
e	2.29 BSC		
H	9.40	-	10.41
L	1.40	-	1.78
L1	2.90 REF		
L2	0.51 BSC		
L3	0.89	-	1.27
L4	-	-	1.01
Z	3.93	-	-
θ	0°	-	10°
θ1	0°	-	10°
θ2	10°	-	20°
θ3	0°	-	10°
θ4	0°	-	10°

10. Part Numbering and Marking



GD8205A = Device Code
 A = Assembly Location
 XX = Lot Number
 Y = Year
 WW = Work Week

11. Packing Options

Part Number	Package	Packing Mode	M.O.Q.
LGD8205ATI	DPAK (Pb-Free)	Tape & Reel	2500

For additional information please visit www.Littelfuse.com/powersemi

Disclaimer Notice - Littelfuse products are not designed for, and shall not be used for, any purpose (including, without limitation, automotive, military, aerospace, medical, life-saving, life-sustaining or nuclear facility applications, devices intended for surgical implant into the body, or any other application in which the failure or lack of desired operation of the product may result in personal injury, death, or property damage) other than those expressly forth in applicable Littelfuse product documentation. Littelfuse shall not be liable for any claims or damages arising out of products used in applications not expressly intended by Littelfuse as set forth in applicable Littelfuse documentation.

Read complete Disclaimer Notice at www.littelfuse.com/disclaimer-electronics