

### 398 Series, TE5® Modul Protector® Fuse

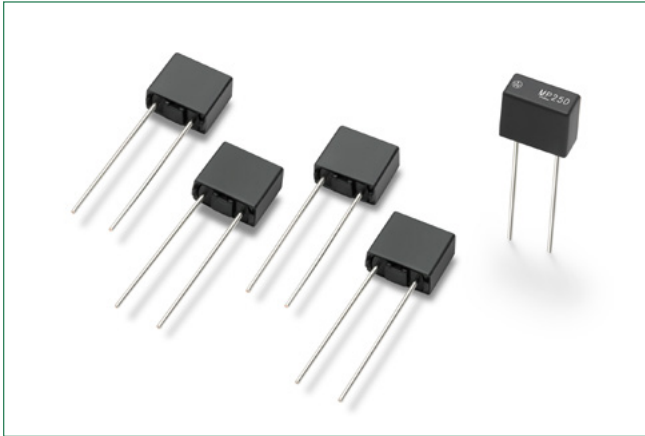

#### Description

The 398 Series TE5® Fuses are short circuit protectors, medium Time-Lag type, and 65V rated.

#### Features

- Reduced PCB space requirements
- Highly defined cut-off times
- Low internal resistance
- Flame resistant encapsulated casing
- Available from 0.125A to 4A
- Halogen free, Lead-free and RoHS compliant

#### Agency Approvals

Agency	Agency File Number	Ampere Range
	E67006	0.125A - 4A

#### Applications

- Microprocessor protection

#### Additional Information



Datasheet



Resources



Samples

#### Electrical Characteristics

% of Ampere Rating	Opening Time
300	10 Seconds, <b>Max.</b>

#### Electrical Characteristics

Amp Code	Rated Current	Marking Code*	Voltage Rating	Breaking Capacity	Nominal Cold Resistance (Ohms)	Cold Resistance $0.1 \times I_N$ typ. (mΩ)	Power Dissipation $1.0 \times I_N$ max. (mW)	Melting Integral $10 \times I_N$ max. (A <sup>2</sup> s)	Agency Approvals 
0125	125mA	MP13	65V	50A@65 VAC/DC	0.9610	900	50	0.036	x
0250	250mA	MP25	65V		0.3540	355	50	0.063	x
0315	315mA	MP32	65V		0.2600	261	60	0.08	x
0400	400mA	MP40	65V		0.1860	186	75	0.18	x
0500	500mA	MP50	65V		0.1540	155	90	0.33	x
0630	630mA	MP63	65V		0.1150	115	120	0.48	x
0800	800mA	MP80	65V		0.0850	85	140	1.02	x
1100	1.00A	MP100	65V		0.0640	65	170	1.10	x
1125	1.25A	MP125	65V		0.0480	48	210	2.34	x
1160	1.60A	MP160	65V		0.0340	34	320	4.66	x
1200	2.00A	MP200	65V		0.0260	26	425	8.40	x
1250	2.50A	MP250	65V		0.0210	21	550	14.81	x
1315	3.15A	MP315	65V		0.0155	16	650	29.27	x
1400	4.00A	MP400	65V		0.0120	12	1000	41.12	x

#### Notes:

1. 1.00 means the number one with two decimal places, 1,000 means the number one thousand.
2. Resistance is measured at 10% of rated current, 25°C.

\* Physical Marking on top of the device

**Temperature Re-rating Curve**

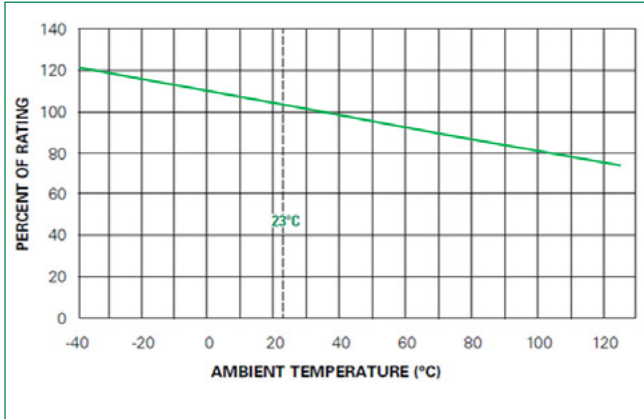

**Note:**  
1. Derating depicted in this curve is in addition to the standard derating of 25% for continuous operation.

**Average Time Current Curves**

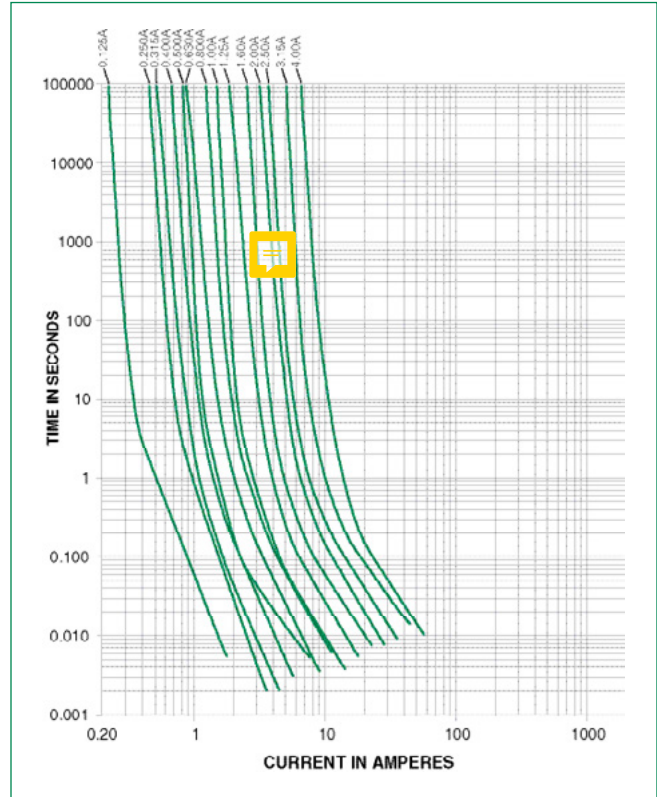

**Soldering Parameters - Wave Soldering**

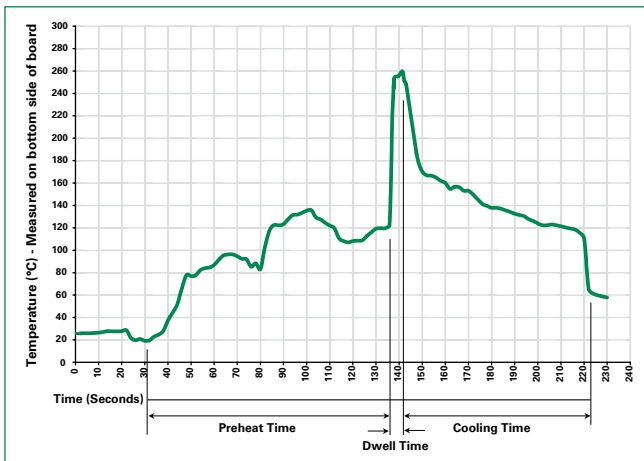

**Recommended Process Parameters:**

Wave Parameter	Lead-Free Recommendation
<b>Preheat:</b> (Depends on Flux Activation Temperature)	(Typical Industry Recommendation)
<b>Temperature Minimum:</b>	100°C
<b>Temperature Maximum:</b>	150°C
<b>Preheat Time:</b>	60-180 seconds
<b>Solder Pot Temperature:</b>	260°C Maximum
<b>Solder Dwell Time:</b>	2-5 seconds

**Recommended Hand-Solder Parameters:**

Solder Iron Temperature: 350°C +/- 5°C  
Heating Time: 5 seconds max.

**Note:** These devices are not recommended for IR or Convection Reflow process.

### Product Characteristics

<b>Materials</b>	Base/Cap: Thermoplastic Polyamide PA 6.6, UL 94V-0 Round Pins: Copper, Tin-plated
<b>Lead Pull Strength</b>	10N (EN 60068-2-21)
<b>Solderability</b>	260°C, ≤ 3s. (Wave) 350°C, ≤ 1s. (Soldering Iron)
<b>Soldering Heat Resistance</b>	260°C, 10s. (IEC 60068-2-20) 350°C, 3s. (Soldering Iron)

<b>Operating Temperature</b>	-40°C to +125°C (Consider re-rating)
<b>Climatic Category</b>	-40°C to +85°C/21 days (IEC 60068-1,-2-1,-2-2,-78)
<b>Stock Conditions</b>	+10°C to +60°C RH, ≤ 75% yearly average, without dew, maximum value for 30 days-95%
<b>Vibration Resistance</b>	24 cycles at 15 min. each (IEC 60068-6) 10 - 60Hz at 0.75mm amplitude 60 - 2000Hz at 10g acceleration

### Dimensions

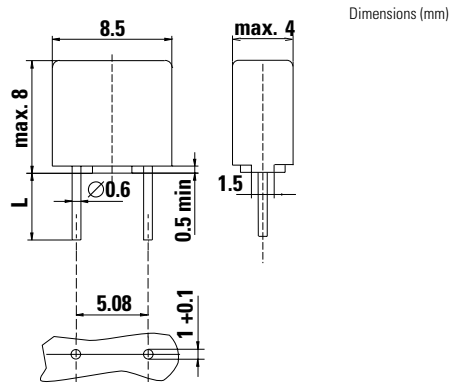

### Part Numbering System



### Packaging

Packaging Option	Packaging Specification	Quantity	Quantity & Packaging Code	Reel Size
<b>398 Series</b>				
Tape & Ampopack	N/A	1,400	0000	N/A