

601/602 Series Shock-Safe Panel Mount Fuse Holder for 5x20mm Fuses

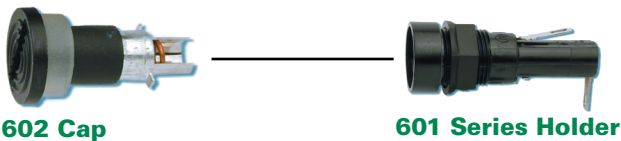

**602 Cap**  
Design 00: without silicon washer (IP 40)  
Design 04: with silicon washer (IP 54)  
(from front side only)

**601 Series Holder**

**Dimensions** (in mm)

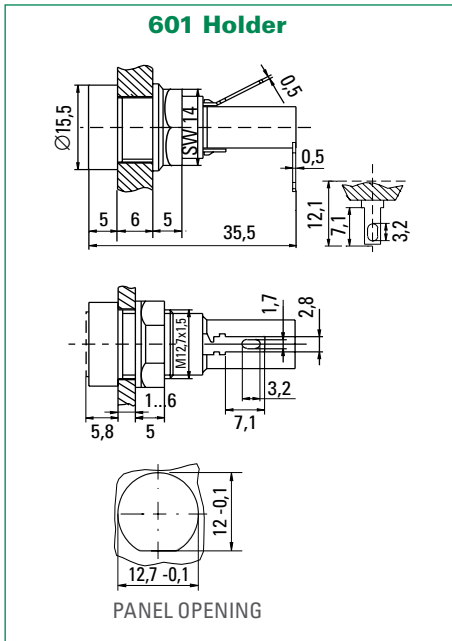
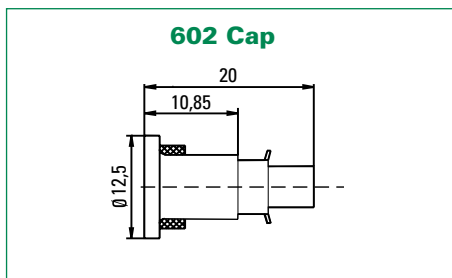

Product Characteristics	
<b>Compatible Fuses</b>	<b>5x20mm</b>
<b>Materials</b>	<b>Holder:</b> Black Duroplast Phenolplast PF, UL94 V-0
	<b>Cap:</b> Black Thermoplastic Polyamide PA6.6, UL94 V-0
	<b>Sealing Washer:</b> Novapress Multi (Cap 602 04)
	<b>Metal Parts:</b> Copper alloy, corrosion protected
<b>Electrical Data (23°C)</b>	<b>Terminals:</b> Solderable, tinned
	<b>Rated Voltage:</b> 250V
	<b>Rated Current:</b> 6.3A (SEMKO/VDE) 16A (UL/CSA) <b>Rated Power:</b> 4W (SEMKO/VDE)
<b>Mounting</b>	12.7mm diameter D-hole Admissible torque on plastic hex nut is 1.2Nm
<b>Terminals</b>	Solderable or 2.8mm quick connect-fits 0.5mm tab
<b>Protection Class &amp; Category</b>	IP 40 (with Cap 602 00 acc. to IEC 60529) IP 54 (with Cap 602 04 acc. to IEC 60529) PC2 (IEC 60127-6)
<b>Operating Temperature</b>	-25°C to +70°C (consider de-rating)
<b>Climatic Test</b>	-25°C/+70°C/21 days (IEC 60068-2-1...3)
<b>Stock Conditions</b>	+10°C to +60°C relative humidity ≤ 75% yearly average, without dew, maximum value for 30 days - 95%
<b>Vibration Resistance</b>	24 cycles at 15 min. each (IEC 60068-2-6) 10 - 60Hz at 0.75mm amplitude 60 - 2000Hz at 10g acceleration
<b>Dielectric Strength</b>	> 1.5 kV
<b>Impulse Voltage</b>	4 kV, 50 Hz, 1 min., dry
<b>Insulation Resistance</b>	> 10 <sup>9</sup> MΩ (500 VDC, 1 min.)
<b>Solderability</b>	235°C, 3 sec. (Wave) 350°C, 1 sec. (Soldering Iron)
<b>Soldering Heat Resistance</b>	260°C, 5 sec. (IEC 60068-2-20)
<b>Minimum Cross Section</b>	Conductor - 2.5mm <sup>2</sup>
<b>Marking</b>	601, 250V, Approvals
<b>Unit Weight</b>	4.0g (Holder) / 1.9g (Cap)
<b>Standards</b>	IEC 60127-6 UL 512 CSA C22.2, No. 39
Agency Approvals	
<b>Agency</b>	<b>Agency File Number</b>
	SEMKO certificate <b>608494</b>
	UL Recognized file number <b>E 70164</b>
	CSA Certified: file number <b>47574</b>
	VDE License Number <b>132224</b>
Ordering Information (Packaged bulk 100 pieces)	
<b>Item</b>	<b>Ordering Number</b>
<b>Holder</b>	<b>601 0000 000</b>
<b>Cap, without washer, IP 40</b>	<b>602 0000 000</b>
<b>Cap, with washer, IP 54</b>	<b>602 0000 040</b>

**Additional Information**



Datasheet  
601 Series



Resources  
601 Series



Samples  
601 Series



Datasheet  
602 Series



Resources  
602 Series



Samples  
602 Series

Notes:  
- Please also refer to Littelfuse series 850 and 851 for new designs  
- 1.00 means one with two decimal places and 1,000 means the number one thousand