

# SR70 Series

## 70V 40A Diode Array



### Additional Information



Resources



Accessories



Samples

### Pinout

#### SOT-143-4

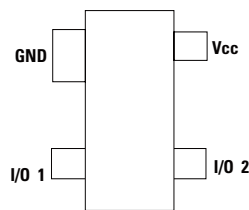

### Description

The SR70 consists of four, low capacitance, rail-to-rail diodes that provide protection against ESD and lightning surge events. These robust diodes can safely absorb up to 40A ( $t_p=8/20\mu s$ ) and repetitive ESD strikes at the maximum level (Level 4) specified in the IEC 61000-4-2 international standard without performance degradation.

Its low loading capacitance makes it ideal for protecting high-speed data lines such as VDSL and VDSL2.

### Features & Benefits

- ESD, IEC61000-4-2,  $\pm 30kV$  contact discharge,  $\pm 30kV$  air discharge
- EFT, IEC61000-4-4, 80A ( $t_p=5/50ns$ )
- Lightning protection, IEC61000-4-5, 40A ( $t_p=8/20\mu s$ )
- Low capacitance of 2.0pF (TYP) per I/O
- Low clamp voltage
- Small SOT143 (JEDEC TO-253) packaging

### Applications

- xDSL Lines
- Video Lines
- Customer Premises Equipment
- 10/100/1000 Ethernet

### Application Example

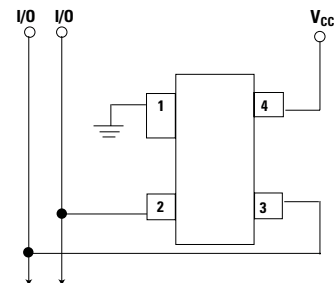

### Functional Block Diagram

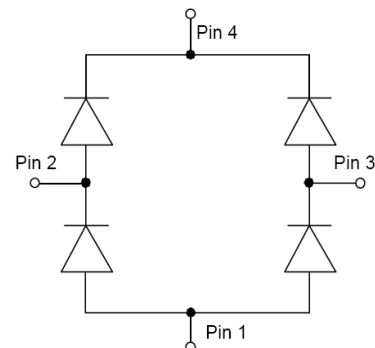

Life Support Note:

#### Not Intended for Use in Life Support or Life Saving Applications

The products shown herein are not designed for use in life sustaining or life saving applications unless otherwise expressly indicated.

# SR70 Series

## 70V 40A Diode Array

### Absolute Maximum Ratings

Symbol	Parameter	Value	Units
$I_{PP}$	Peak Current ( $t_p=8/20\mu s$ )	40.0	A
$T_{OP}$	Operating Temperature	-40 to 125	°C
$T_{STOR}$	Storage Temperature	-55 to 150	°C

**Caution:** Stresses above those listed in "Absolute Maximum Ratings" may cause permanent damage to the device. This is a stress only rating and operation of the device at these or any other conditions above those indicated in the operational sections of this specification is not implied.

### Thermal Information

Parameter	Rating	Units
Storage Temperature Range	-55 to 150	°C
Maximum Junction Temperature	150	°C
Maximum Lead Temperature (Soldering 20-40s)	260	°C

### Electrical Characteristics ( $T_{OP}=25^\circ C$ )

Parameter	Symbol	Test Conditions	Min	Typ	Max	Units
Reverse Standoff Voltage	$V_{RWM}$				70	V
Reverse Leakage Current	$I_{LEAK}$	$V_R=70V$			5	$\mu A$
Clamp Voltage <sup>1</sup>	$V_C$	$I_{PP}=1A, t_p=8/20\mu s, Fwd$		1.4		V
		$I_{PP}=10A, t_p=8/20\mu s, Fwd$		4.7		V
		$I_{PP}=30A, t_p=8/20\mu s, Fwd$		12		V
Dynamic Resistance	$R_{DYN}$	$(V_{C2}-V_{C1})/(I_{PP2}-I_{PP1})$		0.35		$\Omega$
ESD Withstand Voltage <sup>1</sup>	$V_{ESD}$	IEC61000-4-2 (Contact)	$\pm 30$			kV
		IEC61000-4-2 (Air)	$\pm 30$			kV
Diode Capacitance <sup>1</sup>	$C_{I/O-GND}$	Reverse Bias=0V, f=1MHz		2.0	3.0	pF
	$C_{I/O-I/O}$	Reverse Bias=0V, f=1MHz		1.3	2.0	pF

**Note: 1.** Parameter is guaranteed by design and/or device characterization.

### Capacitance vs. Reverse Bias

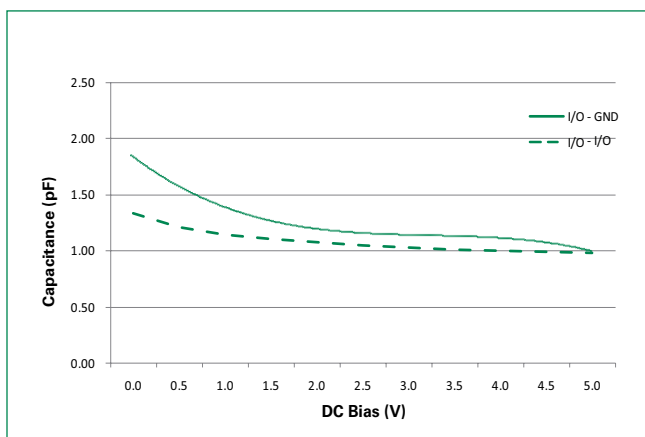

### Pulse Waveform

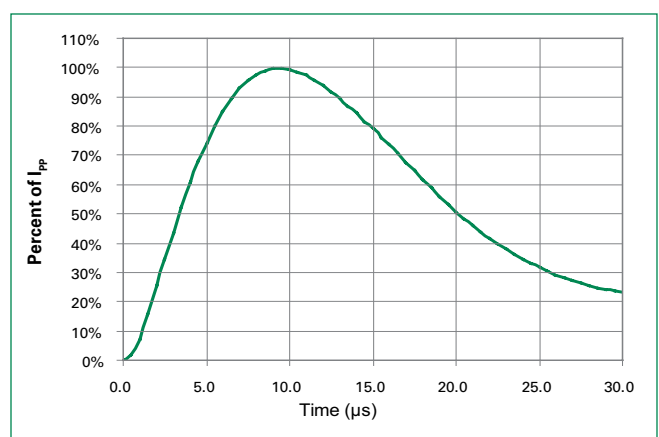

# SR70 Series

## 70V 40A Diode Array

### Clamping Voltage vs. $I_{pp}$

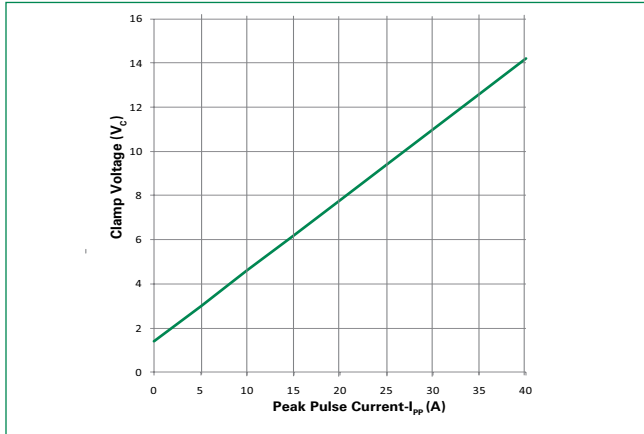

### Product Characteristics

<b>Lead Plating</b>	Matte Tin
<b>Lead Material</b>	Copper Alloy
<b>Lead Coplanarity</b>	0.0004 inches (0.102mm)
<b>Substitute Material</b>	Silicon
<b>Body Material</b>	Molded Epoxy
<b>Flammability</b>	UL 94 V-0

**Notes :**

1. All dimensions are in millimeters
2. Dimensions include solder plating.
3. Dimensions are exclusive of mold flash & metal burr.
4. Blo is facing up for mold and facing down for trim/form, i.e. reverse trim/form.
5. Package surface matte finish VDI 11-13.

### Soldering Parameters

<b>Reflow Condition</b>	Pb – Free assembly	
<b>Pre Heat</b>	- Temperature Min ( $T_{s(min)}$ )	150°C
	- Temperature Max ( $T_{s(max)}$ )	200°C
	- Time (min to max) ( $t_s$ )	60 – 180 secs
<b>Average ramp up rate (Liquidus) Temp (<math>T_L</math>) to peak</b>	3°C/second max	
<b><math>T_{s(max)}</math> to <math>T_L</math> - Ramp-up Rate</b>	3°C/second max	
<b>Reflow</b>	- Temperature ( $T_L$ ) (Liquidus)	217°C
	- Temperature ( $t_L$ )	60 – 150 seconds
<b>Peak Temperature (<math>T_p</math>)</b>	260 <sup>+0/-5</sup> °C	
<b>Time within 5°C of actual peak Temperature (<math>t_p</math>)</b>	20 – 40 seconds	
<b>Ramp-down Rate</b>	6°C/second max	
<b>Time 25°C to peak Temperature (<math>T_p</math>)</b>	8 minutes Max.	
<b>Do not exceed</b>	260°C	

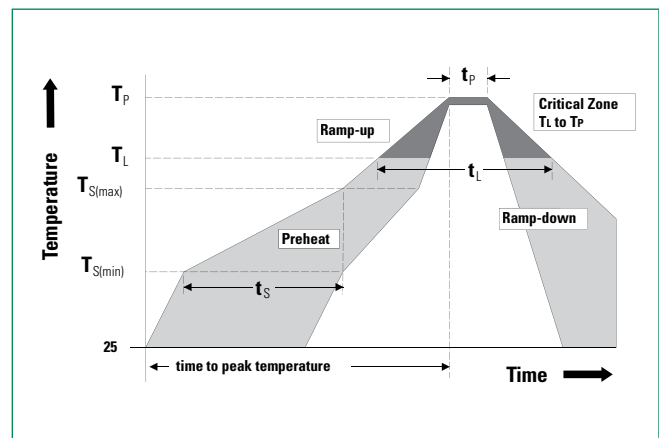

### Part Numbering System

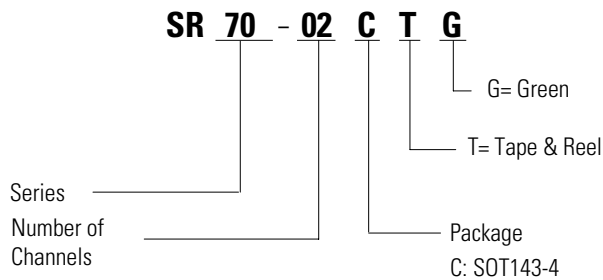

### Ordering Information

Part Number	Package	Marking	Min. Order Qty.
SR70-02CTG	SOT143	702C	3000

### Part Marking System



# SR70 Series

## 70V 40A Diode Array

### Package Dimensions—SOT143

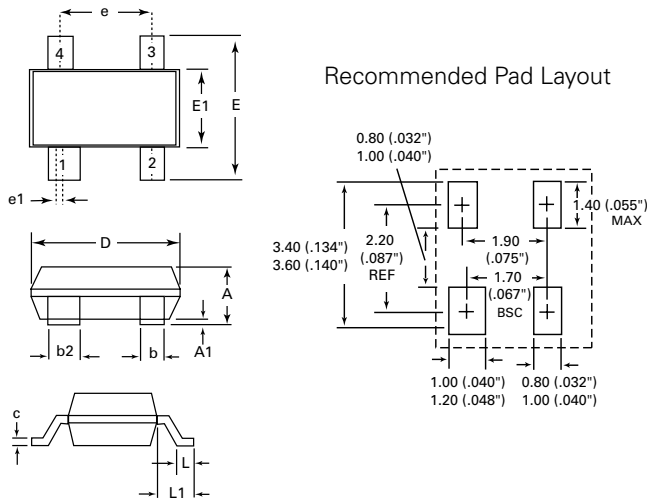

Package	SOT143			
Pins	4			
JEDEC	TO-253			
	Millimeters		Inches	
	Min	Max	Min	Max
<b>A</b>	0.8	1.22	0.03	0.048
<b>A1</b>	0.05	0.15	0.002	0.006
<b>b</b>	0.30	0.50	0.012	0.020
<b>b2</b>	0.76	0.89	0.030	0.035
<b>c</b>	0.08	0.20	0.003	0.008
<b>D</b>	2.80	3.04	0.110	0.120
<b>E</b>	2.10	2.64	0.082	0.104
<b>E1</b>	1.20	1.40	0.047	0.055
<b>e</b>	1.92 BSC		0.076 BSC	
<b>e1</b>	0.20 BSC		0.008 BSC	
<b>L</b>	0.4	0.6	0.016	0.024
<b>L1</b>	0.550 REF		0.022 REF	

### Embossed Carrier Tape & Reel Specification—SOT143

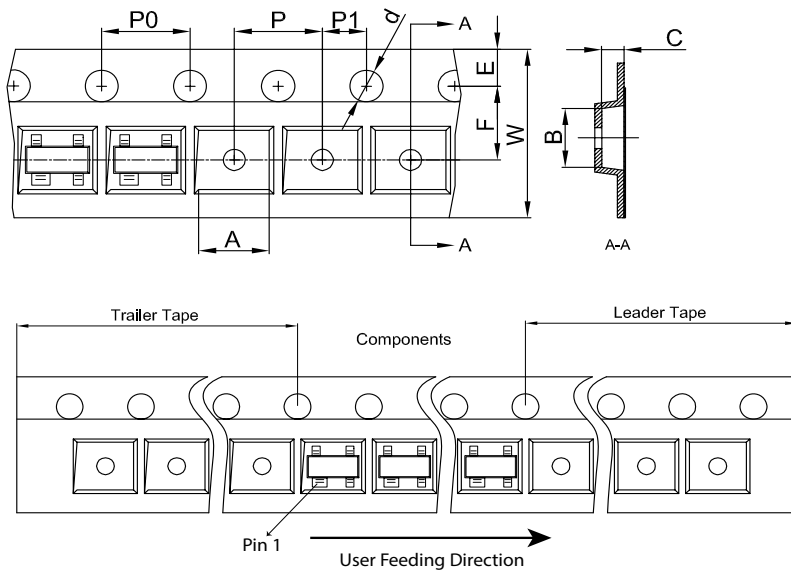

Symbol	Millimeters
<b>A</b>	3.19±0.10
<b>B</b>	2.8±0.10
<b>C</b>	1.31±0.10
<b>d</b>	∅ 1.50±0.10
<b>E</b>	1.75±0.10
<b>F</b>	3.50±0.10
<b>P0</b>	4.00±0.10
<b>P</b>	4.00±0.10
<b>P1</b>	2.00±0.10
<b>W</b>	8.00±0.10

Notes:  
1. All dimensions are in millimeters

**Disclaimer Notice** - Information furnished is believed to be accurate and reliable. However, users should independently evaluate the suitability of and test each product selected for their own applications. Littelfuse products are not designed for, and may not be used in, all applications. Read complete Disclaimer Notice at [www.littelfuse.com/disclaimer-electronics](http://www.littelfuse.com/disclaimer-electronics).