

### DURF1040CTR

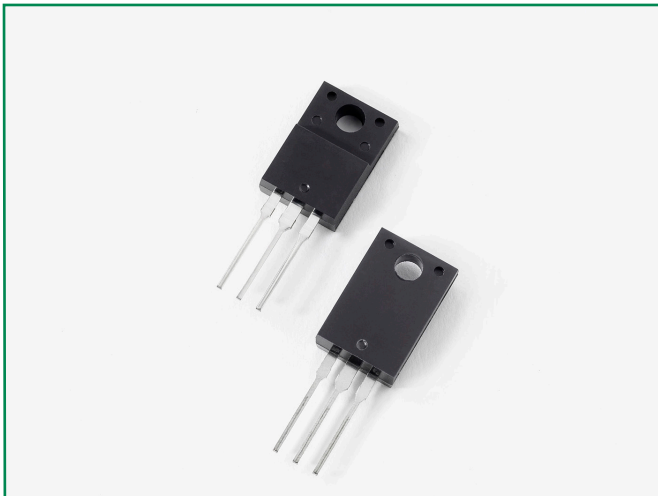

#### Description

Littelfuse DUR series Ultrafast Recovery Rectifier is designed to meet the general requirements of commercial applications by providing low  $T_{rr}$ , high-temperature, low-leakage and low forward voltage drop products. It is suitable for output rectifier, free-wheeling or boost diode in high-frequency power switching application such as switch mode power supply and DC-DC converters.

#### Features

- Ultra-fast switching
  - Low reverse leakage current
  - High surge current capability
  - Low forward voltage drop
  - Common Anode
- configuration in electrically isolated ITO-220AB package
- Pb-free E3 means 2nd level interconnect is Pb-free and the terminal finish material is tin(Sn) (IPC/JEDEC J-STD-609A.01)

#### Circuit Diagram

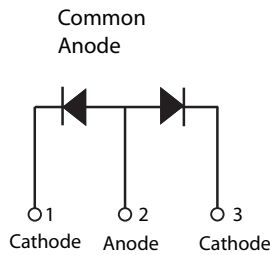

#### Applications

- Output rectifiers in switch mode power supplies (SMPS) and DC to DC converters
- Free-wheeling diode or boost diode in converters and motor control circuits
- Anti-parallel diode for high frequency switching devices such as IGBT
- Uninterruptible Power Supplies (UPS)
- Inductive heating and melting
- Ultrasonic cleaners and welders

#### Maximum Ratings

Characteristics	Symbol	Conditions	Max.	Unit
Peak Inverse Voltage	$V_{RWM}$	-	400	V
Average Forward Current	$I_{O(AV)}$	50% duty cycle @ $T_c = 112^\circ\text{C}$ , rectangular wave form	5 ( Per Leg)	A
			10 ( Total Device)	
Peak One Cycle Non-Repetitive Surge Current	$I_{FSM}$	8.3 ms, half sine pulse	80	A

#### Electrical Characteristics

Characteristics	Symbol	Conditions	Max.	Unit
Forward Voltage Drop ( Per Leg)	$V_F$	@ $I_F = 5\text{A}$ , Pulse, $T_j = 25^\circ\text{C}$	1.3	V
Reverse Current	$I_{R1}$	@ $V_R = \text{Rated } V_R$ , $T_j = 25^\circ\text{C}$	30	$\mu\text{A}$
		@ $V_R = \text{Rated } V_R$ , $T_j = 125^\circ\text{C}$	300	
Reverse Recovery Time	$t_{rr1}$	$I_F = 500\text{mA}$ , $I_R = 1\text{A}$ , and $I_{rm} = 250\text{mA}$	45	ns

Footnote 1: Pulse Width < 300 $\mu\text{s}$ , Duty Cycle < 2%

### Thermal-Mechanical Specifications

Characteristics	Symbol	Conditions	Specification	Unit
Junction Temperature	$T_J$	-	-55 to +150	°C
Storage Temperature	$T_{stg}$	-	-55 to +150	°C
Typical Thermal Resistance Junction to Case	$R_{\theta JC}$	DC operation	3.5	°C/W
Approximate Weight	wt	-	2.0	g
Case Style	-	ITO-220AB	-	-

Figure 1: Typical Forward Characteristics

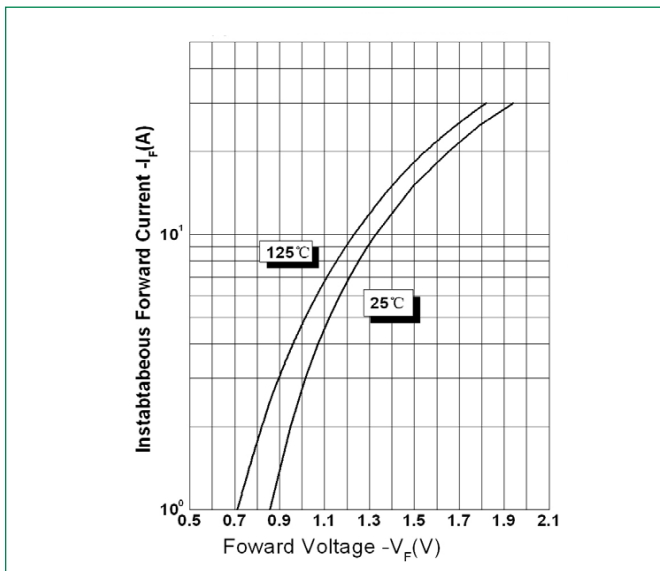

Figure 2: Typical Reverse Characteristics

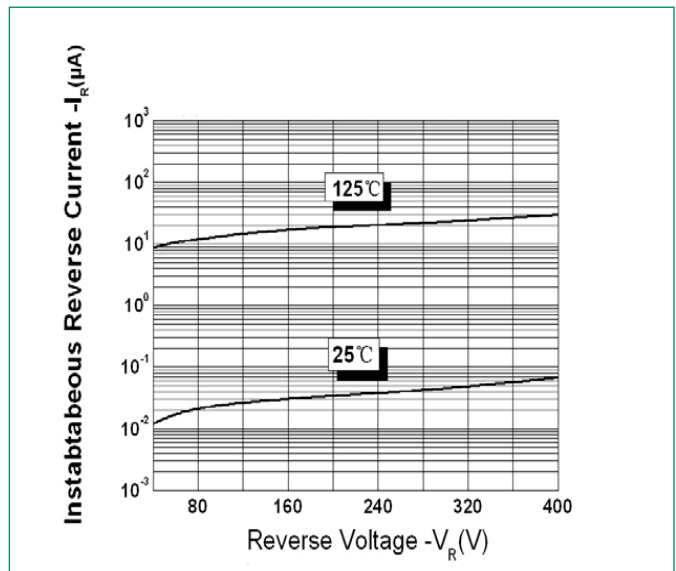
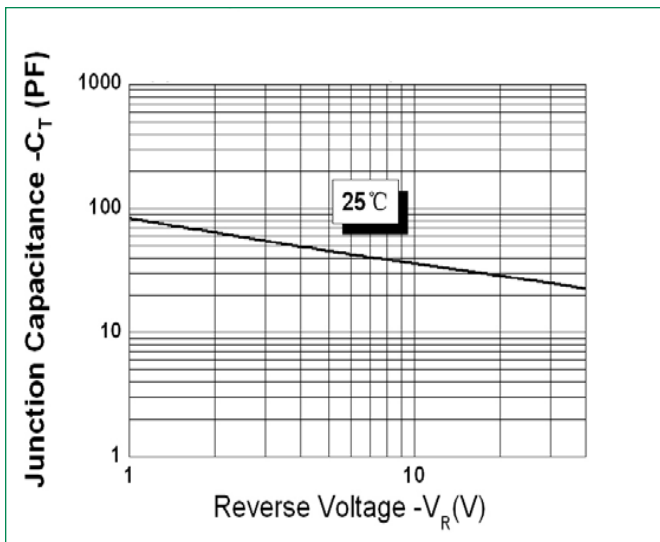
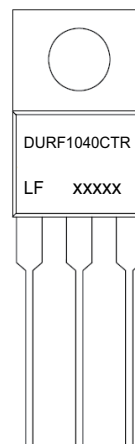

Figure 3: Typical Junction Capacitance



### Part Numbering and Marking System



- \*xxxxx is YYWWL
- DUR = Device Type
  - F = Package type
  - 10 = Forward Current (10A)
  - 40 = Reverse Voltage (400V)
  - CTR = Configuration
  - LF = Littelfuse
  - YY = Year
  - WW = Week
  - L = Lot Number

# Ultrafast Recovery Rectifier

DURF1040CTR, 2x 5A, 400V, ITO-220AB, Common Anode



Expertise Applied | Answers Delivered

## Packing Options

Part Number	Marking	Packing Mode	M.O.Q
DURF1040CTR	DURF1040CTR	50pcs /Tube	1000

## Dimensions-Package ITO-220AB

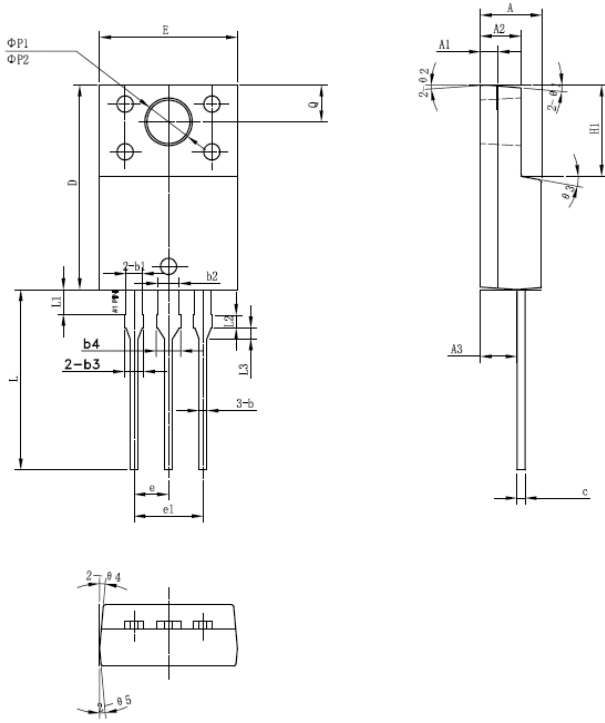

Symbol	Millimeters		
	Min	Typ	Max
A	4.30	4.50	4.70
A1	1.10	1.30	1.50
A2	2.80	3.00	3.20
A3	2.50	2.70	2.90
b	0.50	0.60	0.75
b1	1.10	1.20	1.35
b2	1.50	1.60	1.75
b3	1.20	1.30	1.45
b4	1.60	1.70	1.85
c	0.55	0.60	0.75
D	14.80	15.00	15.20
E	9.96	10.16	10.36
e		2.55	
e1		5.10	
H1	6.50	6.70	6.90
L	12.70	13.20	13.70
L1	1.60	1.80	2.00
L2	0.80	1.00	1.20
L3	0.60	0.80	1.00
$\phi P1$	3.30	3.50	3.70
$\phi P2$	2.99	3.19	3.39
Q	2.50	2.70	2.90
$\theta 1$		5°	
$\theta 2$		4°	
$\theta 3$		10°	
$\theta 4$		5°	
$\theta 5$		5°	

## Tube Specification ITO-220AB

