

# SMCJ Series

## Surface Mount – 1500W



### Additional Information



Resources



Accessories



Samples

### Agency Approvals

Agency	Agency File Number
	E230531

### Maximum Ratings and Thermal Characteristics ( $T_A=25^{\circ}\text{C}$ unless otherwise noted)

Parameter	Symbol	Value	Unit
Peak Pulse Power Dissipation(Fig.2) by 10/1000us Test Waveform(Fig.4) (Note 1),(Note 2)-Single Die Parts	$P_{PPM}$	1500	W
Peak Pulse Power Dissipation(Fig.2) by 10/1000us Test Waveform(Fig.4) (Note 1), (Note 2)-Stacked Die Parts (Note 5)	$P_{PPM}$	2000	W
Power Dissipation on Infinite Heat Sink at $T_J=50^{\circ}\text{C}$	$P_D$	6.5	W
Peak Forward Surge Current, 8.3ms Single Half Sine Wave (Note 3)	$I_{FSM}$	200	A
Maximum Instantaneous Forward Voltage at 100A for Unidirectional Only (Note 4)	$V_F$	3.5/5.0	V
Operating Temperature Range	$T_J$	-65 to 150	$^{\circ}\text{C}$
Storage Temperature Range	$T_{STG}$	-65 to 175	$^{\circ}\text{C}$
Typical Thermal Resistance Junction to Lead	$R_{\theta JL}$	15	$^{\circ}\text{C}/\text{W}$
Typical Thermal Resistance Junction to Ambient	$R_{\theta JA}$	75	$^{\circ}\text{C}/\text{W}$

#### Notes:

- Non-repetitive current pulse, per Fig. 4 and derated above  $T_J$  (initial) =  $25^{\circ}\text{C}$  per Fig. 3.
- Mounted on copper pad area of  $0.31 \times 0.31''$  ( $8.0 \times 8.0\text{mm}$ ) to each terminal.
- Measured on 8.3ms single half sine wave or equivalent square wave for unidirectional device only, duty cycle=4 per minute maximum.
- $V_F < 3.5\text{V}$  for single die parts and  $V_F < 5.0\text{V}$  for stacked-die parts.
- For stacked die component details, please refer to part numbers labeled by \* in Electrical Characteristics.

### Description

The SMCJ series is designed specifically to protect sensitive electronic equipment from voltage transients induced by lightning and other transient voltage events.

### Features & Benefits

- 1500W peak pulse power capability at 10/1000 $\mu\text{s}$  waveform, repetition rate (duty cycles):0.01%
- Excellent clamping capability
- Low incremental surge resistance
- Typical  $I_{R}$  less than 1 $\mu\text{A}$  when  $V_{BR \text{ min}} > 12\text{V}$
- For surface mounted applications to optimize board space
- Low profile package
- Built-in strain relief
- Typical failure mode is short from over-specified voltage or current
- Whisker test is conducted based on JEDEC JESD201A per its table 4a and 4c
- IEC 61000-4-2 ESD 30kV(Air), 30kV (Contact)
- ESD protection of data lines in accordance with IEC 61000-4-2
- EFT protection of data lines in accordance with IEC 61000-4-4
- Fast response time: typically less than 1.0ps from 0V to BV min
- Glass passivated chip junction
- High temperature to reflow soldering guaranteed:  $260^{\circ}\text{C}/30\text{sec}$
- $V_{BR} @ T_J = V_{BR} @ 25^{\circ}\text{C} \times (1 + \alpha T \times (T_J - 25))$  ( $\alpha$ : Temperature Coefficient, typical value is 0.1%)
- Plastic package is flammability rated V-0 per Underwriters Laboratories
- Meet MSL level1, per J-STD-020, LF maximum peak of  $260^{\circ}\text{C}$
- Matte tin lead-free plated
- Halogen free and RoHS compliant
- Pb-free E3 means 2nd level interconnect is Pb-free and the terminal finish material is tin(Sn) (IPC/JEDEC J-STD-609A.01)

### Applications

TVS devices are ideal for the protection of I/O Interfaces, VCC bus and other vulnerable circuits used in Telecom, Computer, Industrial and Consumer electronic applications.

### Functional Diagram

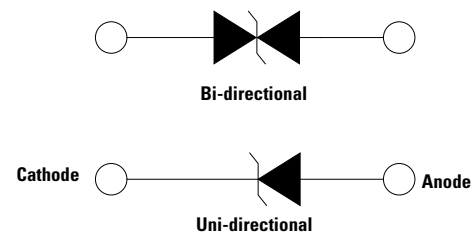

# SMCJ Series

## Surface Mount – 1500W

### Electrical Characteristics ( $T_A=25^\circ\text{C}$ unless otherwise noted)

Part Number (Uni)	Part Number (Bi)	Marking		Reverse Stand off Voltage $V_R$ (Volts)	Breakdown Voltage $V_{BR}$ (Volts) @ $I_T$		Test Current $I_T$ (mA)	Maximum Clamping Voltage $V_C$ @ $I_{PP}$ (V)	Maximum Peak Pulse Current $I_{PP}$ (A)	Maximum Reverse Leakage $I_R$ @ $V_R$ ( $\mu\text{A}$ )	Agency Approval 
		UNI	BI		MIN	MAX					
SMCJ5.0A	SMCJ5.0CA	GDE	BDE	5.0	6.40	7.00	10	9.2	163.0	800	X
SMCJ6.0A	SMCJ6.0CA	GDG	BDG	6.0	6.67	7.37	10	10.3	145.7	800	X
SMCJ6.5A	SMCJ6.5CA	GDK	BDK	6.5	7.22	7.98	10	11.2	134.0	500	X
SMCJ7.0A	SMCJ7.0CA	GDM	BDM	7.0	7.78	8.60	10	12.0	125.0	200	X
SMCJ7.5A	SMCJ7.5CA	GDP	BDP	7.5	8.33	9.21	1	12.9	116.3	100	X
SMCJ8.0A	SMCJ8.0CA	GDR	BDR	8.0	8.89	9.83	1	13.6	110.3	50	X
SMCJ8.5A	SMCJ8.5CA	GDT	BDT	8.5	9.44	10.40	1	14.4	104.2	20	X
SMCJ9.0A	SMCJ9.0CA	GDV	BDV	9.0	10.00	11.10	1	15.4	97.4	10	X
SMCJ10A	SMCJ10CA	GDX	BDX	10.0	11.10	12.30	1	17.0	88.3	5	X
SMCJ11A	SMCJ11CA	GDZ	BDZ	11.0	12.20	13.50	1	18.2	82.5	1	X
SMCJ12A	SMCJ12CA	GEE	BEE	12.0	13.30	14.70	1	19.9	75.4	1	X
SMCJ13A	SMCJ13CA	GEG	BEG	13.0	14.40	15.90	1	21.5	69.8	1	X
SMCJ14A	SMCJ14CA	GEK	BEK	14.0	15.60	17.20	1	23.2	64.7	1	X
SMCJ15A	SMCJ15CA	GEM	BEM	15.0	16.70	18.50	1	24.4	61.5	1	X
SMCJ16A	SMCJ16CA	GEP	BEP	16.0	17.80	19.70	1	26.0	57.7	1	X
SMCJ17A	SMCJ17CA	GER	BER	17.0	18.90	20.90	1	27.6	54.4	1	X
SMCJ18A	SMCJ18CA	GET	BET	18.0	20.00	22.10	1	29.2	51.4	1	X
SMCJ20A	SMCJ20CA	GEV	BEV	20.0	22.20	24.50	1	32.4	46.3	1	X
SMCJ22A	SMCJ22CA	GEX	BEX	22.0	24.40	26.90	1	35.5	42.3	1	X
SMCJ24A	SMCJ24CA	GEZ	BEZ	24.0	26.70	29.50	1	38.9	38.6	1	X
SMCJ26A	SMCJ26CA	GFE	BFE	26.0	28.90	31.90	1	42.1	35.7	1	X
SMCJ28A	SMCJ28CA	GFG	BFG	28.0	31.10	34.40	1	45.4	33.1	1	X
SMCJ30A	SMCJ30CA	GFK	BFK	30.0	33.30	36.80	1	48.4	31.0	1	X
SMCJ33A	SMCJ33CA	GFM	BFM	33.0	36.70	40.60	1	53.3	28.2	1	X
SMCJ36A	SMCJ36CA	GFP	BFP	36.0	40.00	44.20	1	58.1	25.9	1	X
SMCJ40A	SMCJ40CA	GFR	BFR	40.0	44.40	49.10	1	64.5	23.3	1	X
SMCJ43A	SMCJ43CA	GFT	BFT	43.0	47.80	52.80	1	69.4	21.7	1	X
SMCJ45A	SMCJ45CA	GFV	BFV	45.0	50.00	55.30	1	72.7	20.6	1	X
SMCJ48A	SMCJ48CA	GFX	BFX	48.0	53.30	58.90	1	77.4	19.4	1	X
SMCJ51A	SMCJ51CA	GFZ	BFZ	51.0	56.70	62.70	1	82.4	18.2	1	X
SMCJ54A	SMCJ54CA	GGE	BGE	54.0	60.00	66.30	1	87.1	17.3	1	X
SMCJ58A	SMCJ58CA	GGG	BGG	58.0	64.40	71.20	1	93.6	16.1	1	X
SMCJ60A	SMCJ60CA	GGK	BGK	60.0	66.70	73.70	1	96.8	15.5	1	X
SMCJ64A	SMCJ64CA	GGM	BGM	64.0	71.10	78.60	1	103.0	14.6	1	X
SMCJ70A	SMCJ70CA	GGP	BGP	70.0	77.80	86.00	1	113.0	13.3	1	X
SMCJ75A	SMCJ75CA	GGR	BGR	75.0	83.30	92.10	1	121.0	12.4	1	X
SMCJ78A	SMCJ78CA	GGT	BGT	78.0	86.70	95.80	1	126.0	11.9	1	X
SMCJ85A	SMCJ85CA	GGV	BGV	85.0	94.40	104.00	1	137.0	11.0	1	X
SMCJ90A	SMCJ90CA	GGX	BGX	90.0	100.00	111.00	1	146.0	10.3	1	X
SMCJ100A	SMCJ100CA	GGZ	BGZ	100.0	111.00	123.00	1	162.0	9.3	1	X
SMCJ110A	SMCJ110CA	GHE	BHE	110.0	122.00	135.00	1	177.0	8.5	1	X
SMCJ120A	SMCJ120CA	GHG	BHG	120.0	133.00	147.00	1	193.0	7.8	1	X
SMCJ130A	SMCJ130CA	GHK	BHK	130.0	144.00	159.00	1	209.0	7.2	1	X
SMCJ150A	SMCJ150CA	GHM	BHM	150.0	167.00	185.00	1	243.0	6.2	1	X
SMCJ160A	SMCJ160CA	GHP	BHP	160.0	178.00	197.00	1	259.0	5.8	1	X
SMCJ170A	SMCJ170CA	GHR	BHR	170.0	189.00	209.00	1	275.0	5.5	1	X
SMCJ180A	SMCJ180CA	GHT	BHT	180.0	201.00	222.00	1	292.0	5.1	1	X
SMCJ200A	SMCJ200CA	GHV	BHV	200.0	224.00	247.00	1	324.0	4.6	1	X
SMCJ220A	SMCJ220CA	GHX	BHX	220.0	246.00	272.00	1	356.0	4.2	1	X
SMCJ250A	SMCJ250CA	GHZ	BHZ	250.0	279.00	309.00	1	405.0	3.7	1	X
SMCJ300A*	SMCJ300CA*	GJE	BJE	300.0	335.00	371.00	1	486.0	4.1	1	X
SMCJ350A*	SMCJ350CA*	GJG	BJG	350.0	391.00	432.00	1	567.0	3.5	1	X
SMCJ400A*	SMCJ400CA*	GJK	BJK	400.0	447.00	494.00	1	648.0	3.0	1	X
SMCJ440A*	SMCJ440CA*	GJM	BJM	440.0	492.00	543.00	1	713.0	2.8	1	X

For bidirectional type having  $V_R$  of 10 volts and less, the  $I_R$  limit is double.

For parts without A, the  $V_{BR}$  is  $\pm 10\%$  and  $V_C$  is 5% higher than with A parts, the parts without A are currently available, but not recommended for new designs. The parts with A are preferred.

For stack-die parts, use \* to label the part number.

# SMCJ Series

## Surface Mount – 1500W

### I-V Curve Characteristics

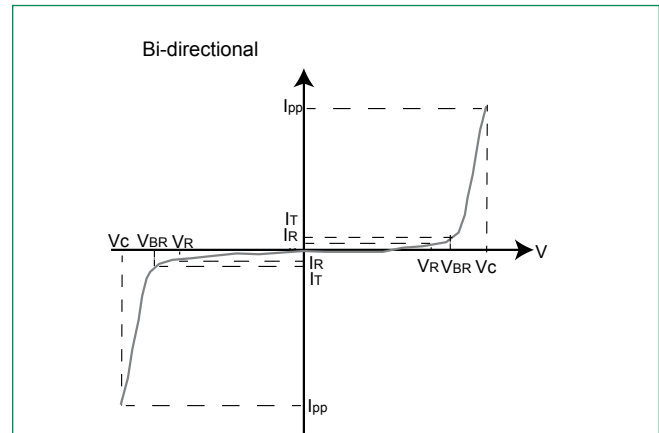
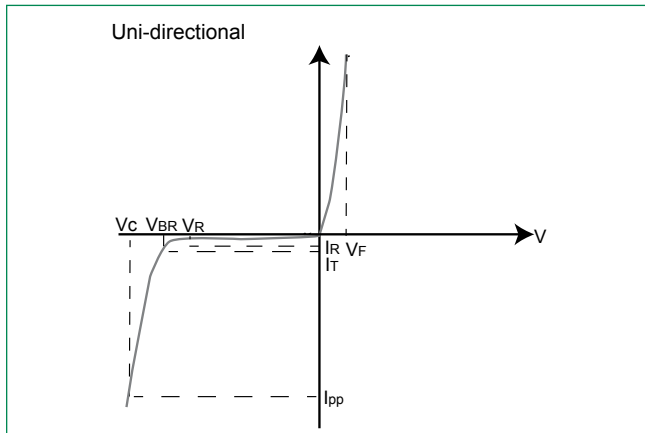

- P<sub>PPM</sub>** Peak Pulse Power Dissipation – Max power dissipation  
**V<sub>R</sub>** Stand-off Voltage – Maximum voltage that can be applied to the TVS without operation  
**V<sub>BR</sub>** Breakdown Voltage – Maximum voltage that flows through the TVS at a specified test current (I<sub>T</sub>)  
**V<sub>C</sub>** Clamping Voltage – Peak voltage measured across the TVS at a specified I<sub>ppm</sub> (peak impulse current)  
**I<sub>R</sub>** Reverse Leakage Current – Current measured at V<sub>R</sub>  
**V<sub>F</sub>** Forward Voltage Drop for Uni-directional

### Ratings and Characteristic Curves (T<sub>A</sub>=25°C unless otherwise noted)

**Figure 1:**  
TVS Transients Clamping Waveform

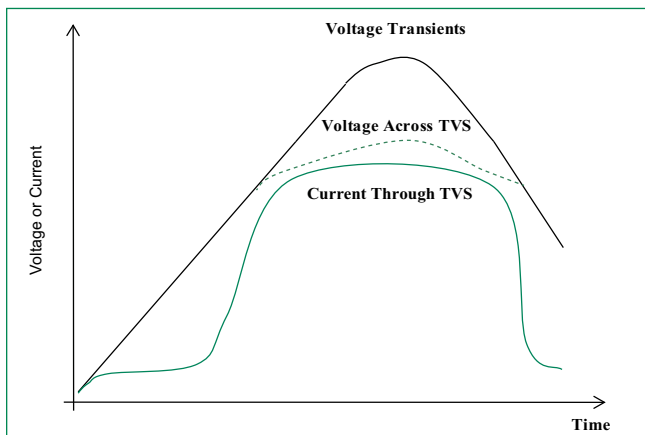

**Figure 2:**  
Peak Pulse Power Rating

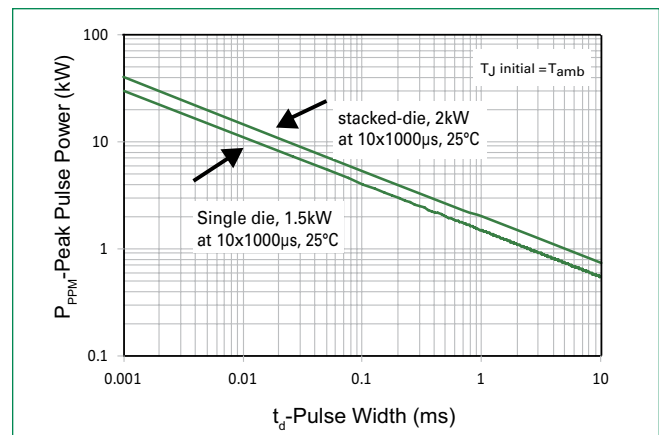

# SMCJ Series

## Surface Mount – 1500W

**Ratings and Characteristic Curves** ( $T_A=25^\circ\text{C}$  unless otherwise noted) (Continued)

**Figure 3:**  
Peak Pulse Power Derating Curve

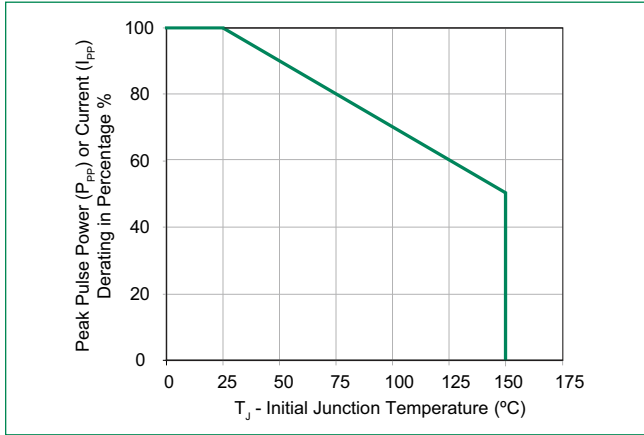

**Figure 4:**  
Pulse Waveform

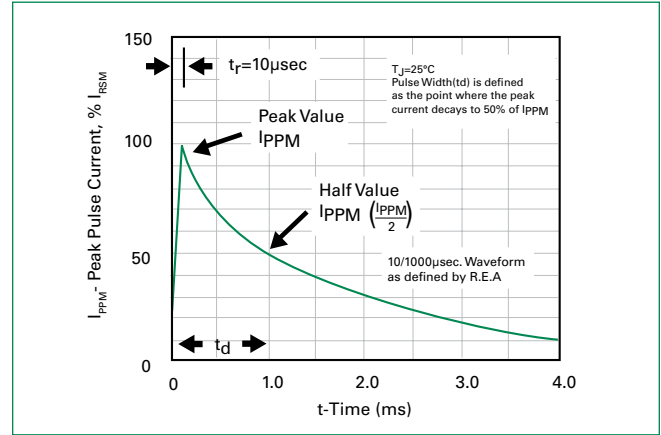

**Figure 5:**  
Typical Junction Capacitance

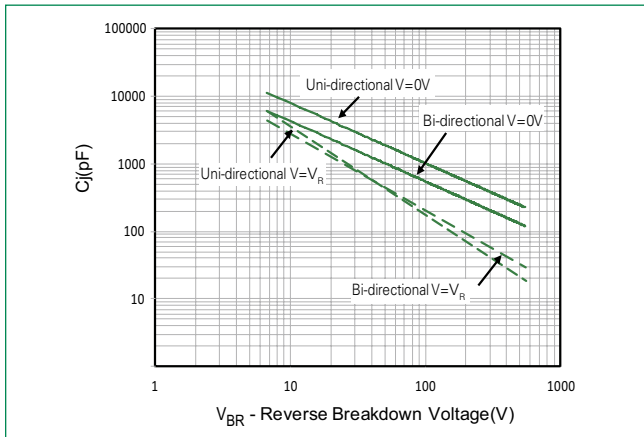

**Figure 6:**  
Typical Transient Thermal Impedance

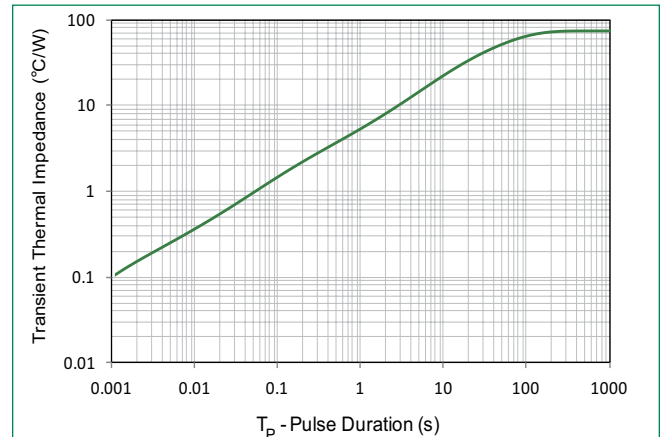

**Figure 7:**  
Maximum Non-Repetitive Peak Forward Surge Current Uni-Directional Only

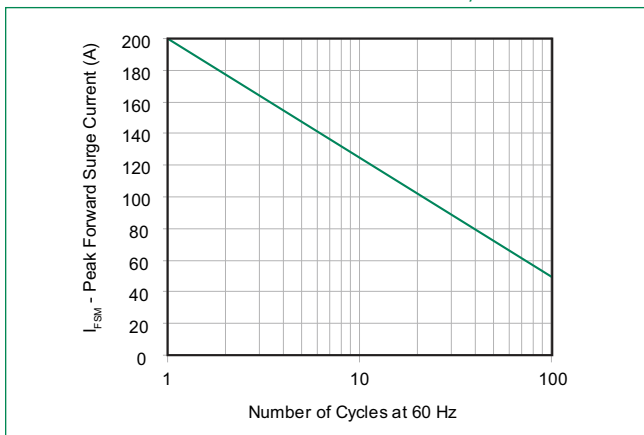

**Figure 8:**  
Peak Forward Voltage Drop vs Peak Forward Current (Typical Values)

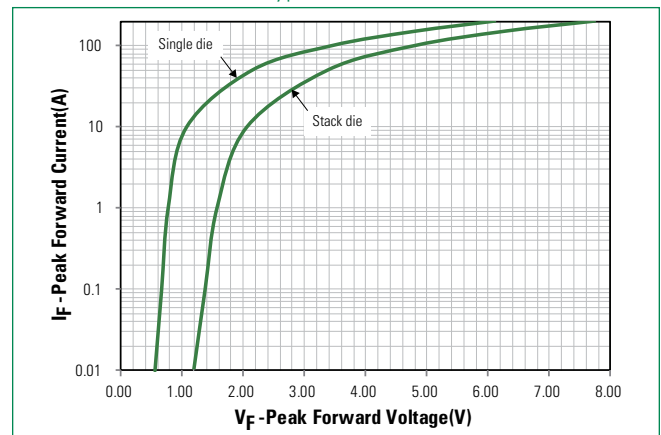

# SMCJ Series

## Surface Mount – 1500W

### Soldering Parameters

<b>Reflow Condition</b>		Lead-free assembly
<b>Pre Heat</b>	- Temperature Min ( $T_{s(min)}$ )	150°C
	- Temperature Max ( $T_{s(max)}$ )	200°C
	- Time (min to max) ( $t_s$ )	60 – 120 secs
<b>Average ramp up rate (Liquidus Temp (<math>T_L</math>) to peak)</b>		3°C/second max
<b><math>T_{s(max)}</math> to <math>T_L</math> - Ramp-up Rate</b>		3°C/second max
<b>Reflow</b>	- Temperature ( $T_L$ ) (Liquidus)	217°C
	- Time (min to max) ( $t_L$ )	60 – 150 seconds
<b>Peak Temperature (<math>T_p</math>)</b>		260 <sup>+0/-5</sup> °C
<b>Time within 5°C of actual peak Temperature (<math>t_p</math>)</b>		30 seconds max
<b>Ramp-down Rate</b>		6°C/second max
<b>Time 25°C to peak Temperature (<math>T_p</math>)</b>		8 minutes Max.
<b>Do not exceed</b>		260°C

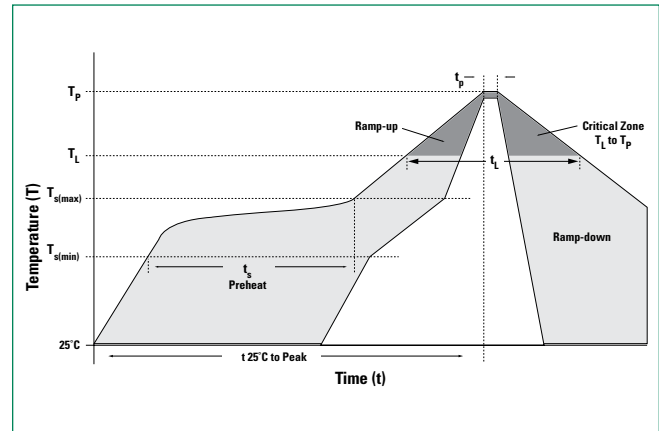

### Physical Specifications

<b>Weight</b>	0.007 ounce, 0.21 grams
<b>Case</b>	JEDEC DO214AB. Molded plastic body over glass passivated junction
<b>Polarity</b>	Color band denotes positive end (cathode) except Bidirectional.
<b>Terminal</b>	Matte Tin-plated leads, Solderable per JESD22-B102

### Environmental Specifications

<b>High Temp. Storage</b>	JESD22-A103
<b>HTRB</b>	JESD22-A108
<b>Temperature Cycling</b>	JESD22-A104
<b>MSL</b>	JEDEC-J-STD-020, Level 1
<b>H3TRB</b>	JESD22-A101
<b>RSH</b>	JESD22-A111

### Dimensions

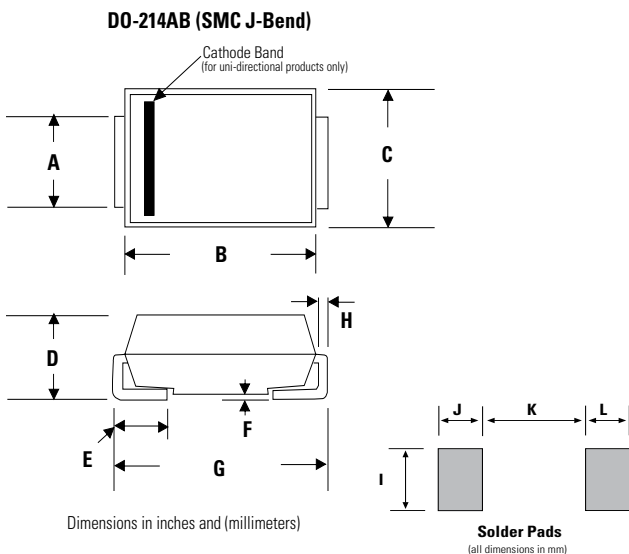

Dimensions	Inches		Millimeters	
	Min	Max	Min	Max
<b>A</b>	0.114	0.126	2.900	3.200
<b>B</b>	0.260	0.280	6.600	7.110
<b>C</b>	0.220	0.245	5.590	6.220
<b>D</b>	0.079	0.103	2.060	2.620
<b>E</b>	0.030	0.060	0.760	1.520
<b>F</b>	-	0.008	-	0.203
<b>G</b>	0.305	0.320	7.750	8.130
<b>H</b>	0.006	0.012	0.152	0.305
<b>I</b>	0.129	-	3.300	-
<b>J</b>	0.094	-	2.400	-
<b>K</b>	-	0.165	-	4.200
<b>L</b>	0.094	-	2.400	-

# SMCJ Series

## Surface Mount – 1500W

### Part Numbering System

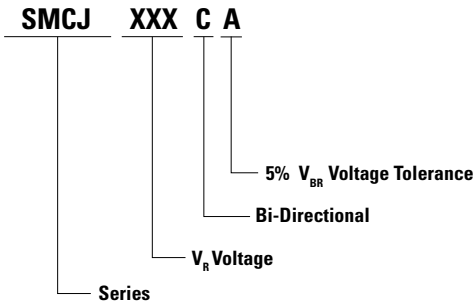

### Part Marking System

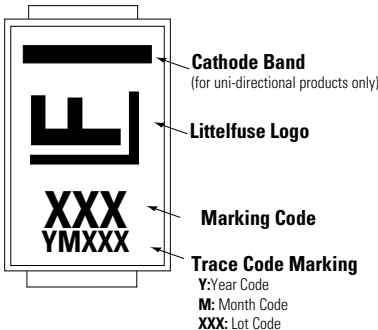

### Packaging

Part number	Component Package	Quantity	Packaging Option	Packaging Specification
SMCJxxxXX	DO-214AB	3000	Tape & Reel - 16mm tape/13" reel	EIA STD RS-481

### Tape and Reel Specification

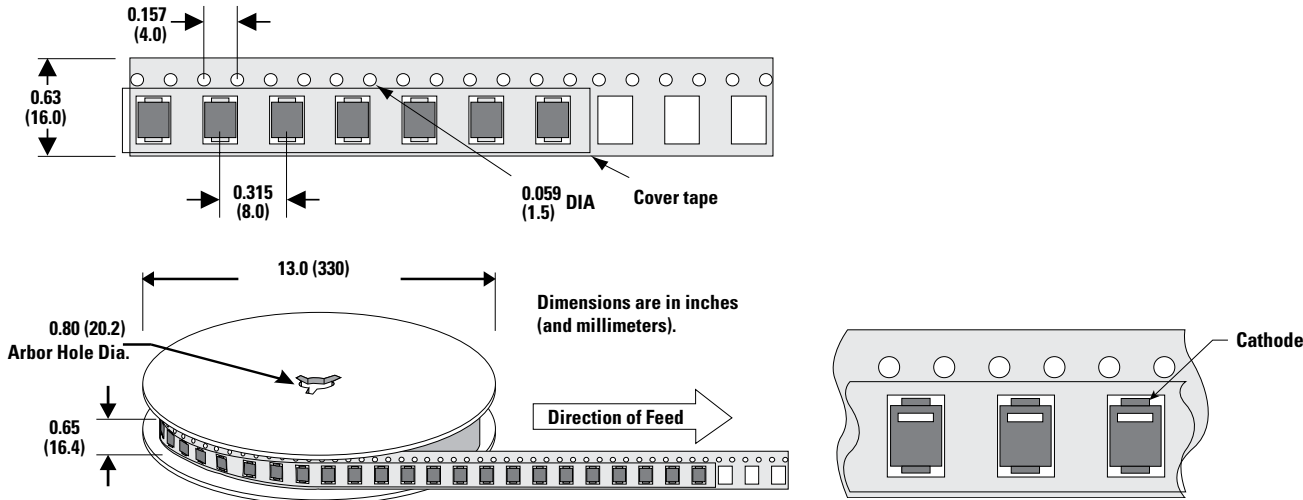

**Disclaimer Notice** - Information furnished is believed to be accurate and reliable. However, users should independently evaluate the suitability of and test each product selected for their own applications. Littelfuse products are not designed for, and may not be used in, all applications. Read complete Disclaimer Notice at [www.littelfuse.com/disclaimer-electronics](http://www.littelfuse.com/disclaimer-electronics).