

5KP-HRA Series

Axial Leaded – 5 kW

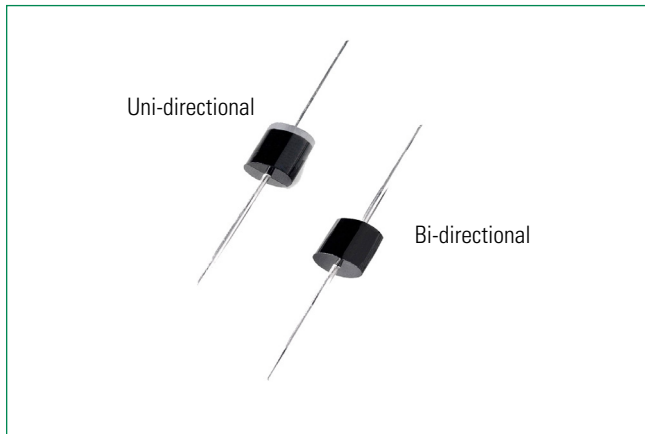

Additional Information



Resources



Accessories



Samples

Agency Approvals

Agency	Agency File Number
	E230531

Maximum Ratings and Thermal Characteristics

($T_A=25^\circ\text{C}$ unless otherwise noted)

Parameter	Symbol	Value	Unit
Peak Pulse Power Dissipation by 10/1000 μs Test Waveform (Fig.2)(Note 1)	P_{PPM}	5	kW
Steady State Power Dissipation on Infinite Heat Sink at $T_L=75^\circ\text{C}$	P_D	8.0	W
Peak Forward Surge Current, 8.3ms Single Half Sine Wave Unidirectional Only (Note 2)	I_{FSM}	400	A
Maximum Instantaneous Forward Voltage at 100A for Unidirectional Only (Note 3)	V_F	3.5/5.0	V
Operating Junction and Storage Temperature Range	T_J, T_{STG}	-55 to 175	$^\circ\text{C}$
Typical Thermal Resistance Junction to Lead	$R_{\theta JL}$	8.0	$^\circ\text{C/W}$
Typical Thermal Resistance Junction to Ambient	$R_{\theta JA}$	40	$^\circ\text{C/W}$

Notes:

1. Non-repetitive current pulse per Fig. 4 and derated above T_J (initial) $=25^\circ\text{C}$ per Fig. 3.
2. Measured on 8.3ms single half sine wave or equivalent square wave, duty cycle=4 per minute maximum.
3. $V_F < 3.5\text{V}$ for single die parts and $V_F < 5.0\text{V}$ for stacked-die parts.

Description

The 5KP-HRA High Reliability Series is designed specifically to protect sensitive electronic equipment from voltage transients induced by lightning and other transient voltage events.

Features & Benefits

- 5 kW peak pulse capability at 10/1000 μs waveform, repetition rate (duty cycles):0.01%
- Glass passivated chip junction in P600 package
- Fast response time: typically less than 1.0ps from 0 Volts to VBR min
- Excellent clamping capability
- Typical failure mode is short from over-specified voltage or current
- Whisker test is conducted based on JEDEC JESD201A per its table 4a and 4c
- IEC-61000-4-2 ESD 30kV(Air), 30kV (Contact)
- EFT protection of data lines in accordance with IEC 61000-4-4
- Low incremental surge resistance
- Typical I_R less than 2 μA when $V_{BR \text{ min}} > 12\text{V}$
- High temperature to reflow soldering guaranteed: 260 $^\circ\text{C}/10\text{sec} / 0.375''$ (9.5mm) lead length, 5 lbs., (2.3kg) tension
- $V_{BR} @ T_J = V_{BR} @ 25^\circ\text{C} \times (1 + \alpha T \times (T_J - 25))$ (αT : Temperature Coefficient, typical value is 0.1%)
- UL Recognized compound meeting flammability rating V-0
- Lead-free matte tin plated package
- Halogen free and RoHS compliant
- Pb-free E3 indicates that 2nd level interconnect is Pb-free and the terminal finish material is tin(Sn) (IPC/JEDEC J-STD-609A.01)
- Recognized to UL 497B as an Isolated Loop Circuit Protector

Applications

TVS Components are ideal for the protection of I/O interfaces, V_{CC} bus and other vulnerable circuits used in telecom, computer, industrial and consumer electronic applications.

Functional Diagram

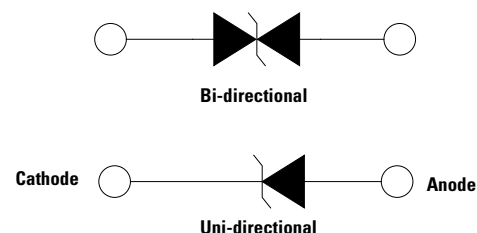

5KP-HRA Series

Axial Leaded – 5 kW

Electrical Characteristics ($T_A=25^\circ\text{C}$ unless otherwise noted)

Part Number (Uni)	Part Number (Bi)	Reverse Stand off Voltage V_R (Volts)	Breakdown Voltage V_{BR} (Volts) @ I_T		Test Current I_T (mA)	Maximum Clamping Voltage V_C @ I_{PP} (V)	Maximum Peak Pulse Current I_{PP} (A)	Maximum Reverse Leakage I_R @ V_R (μA)	Agency Recognition
			MIN	MAX					
5KP5.0A-HRA	5KP5.0CA-HRA	5.0	6.40	7.00	50	9.2	554.3	5000	X
5KP6.0A-HRA	5KP6.0CA-HRA	6.0	6.67	7.37	50	10.3	495.1	5000	X
5KP6.5A-HRA	5KP6.5CA-HRA	6.5	7.22	7.98	50	11.2	455.4	2000	X
5KP7.0A-HRA	5KP7.0CA-HRA	7.0	7.78	8.60	50	12.0	425.0	1000	X
5KP7.5A-HRA	5KP7.5CA-HRA	7.5	8.33	9.21	5	12.9	395.3	250	X
5KP8.0A-HRA	5KP8.0CA-HRA	8.0	8.89	9.83	5	13.6	375.0	150	X
5KP8.5A-HRA	5KP8.5CA-HRA	8.5	9.44	10.40	5	14.4	354.2	50	X
5KP9.0A-HRA	5KP9.0CA-HRA	9.0	10.00	11.10	5	15.4	331.2	20	X
5KP10A-HRA	5KP10CA-HRA	10.0	11.10	12.30	5	17.0	300.0	15	X
5KP11A-HRA	5KP11CA-HRA	11.0	12.20	13.50	5	18.2	280.2	2	X
5KP12A-HRA	5KP12CA-HRA	12.0	13.30	14.70	5	19.9	256.3	2	X
5KP13A-HRA	5KP13CA-HRA	13.0	14.40	15.90	5	21.5	237.2	2	X
5KP14A-HRA	5KP14CA-HRA	14.0	15.60	17.20	5	23.2	219.8	2	X
5KP15A-HRA	5KP15CA-HRA	15.0	16.70	18.50	5	24.4	209.0	2	X
5KP16A-HRA	5KP16CA-HRA	16.0	17.80	19.70	5	26.0	196.2	2	X
5KP17A-HRA	5KP17CA-HRA	17.0	18.90	20.90	5	27.6	184.8	2	X
5KP18A-HRA	5KP18CA-HRA	18.0	20.00	22.10	5	29.2	174.7	2	X
5KP20A-HRA	5KP20CA-HRA	20.0	22.20	24.50	5	32.4	157.4	2	X
5KP22A-HRA	5KP22CA-HRA	22.0	24.00	26.90	5	35.5	143.7	2	X
5KP24A-HRA	5KP24CA-HRA	24.0	26.70	29.50	5	38.9	131.1	2	X
5KP26A-HRA	5KP26CA-HRA	26.0	28.90	31.90	5	42.1	121.1	2	X
5KP28A-HRA	5KP28CA-HRA	28.0	31.10	34.40	5	45.4	112.3	2	X
5KP30A-HRA	5KP30CA-HRA	30.0	33.30	36.80	5	48.4	105.4	2	X
5KP33A-HRA	5KP33CA-HRA	33.0	36.70	40.60	5	53.3	95.7	2	X
5KP36A-HRA	5KP36CA-HRA	36.0	40.00	44.20	5	58.1	87.8	2	X
5KP40A-HRA	5KP40CA-HRA	40.0	44.40	49.10	5	64.5	79.1	2	X
5KP43A-HRA	5KP43CA-HRA	43.0	47.80	52.80	5	69.4	73.5	2	X
5KP45A-HRA	5KP45CA-HRA	45.0	50.00	55.30	5	72.7	70.2	2	X
5KP48A-HRA	5KP48CA-HRA	48.0	53.30	58.90	5	77.4	65.9	2	X
5KP51A-HRA	5KP51CA-HRA	51.0	56.70	62.70	5	82.4	61.9	2	X
5KP54A-HRA	5KP54CA-HRA	54.0	60.00	66.30	5	87.1	58.6	2	X
5KP58A-HRA	5KP58CA-HRA	58.0	64.40	71.20	5	93.6	54.5	2	X
5KP60A-HRA	5KP60CA-HRA	60.0	66.70	73.70	5	96.8	52.7	2	X
5KP64A-HRA	5KP64CA-HRA	64.0	71.10	78.60	5	103.0	49.5	2	X
5KP70A-HRA	5KP70CA-HRA	70.0	77.80	86.00	5	113.0	45.1	2	X
5KP75A-HRA	5KP75CA-HRA	75.0	83.30	92.10	5	121.0	42.1	2	X
5KP78A-HRA	5KP78CA-HRA	78.0	86.70	95.80	5	126.0	40.5	2	X
5KP85A-HRA	5KP85CA-HRA	85.0	94.40	104.00	5	137.0	37.2	2	X
5KP90A-HRA	5KP90CA-HRA	90.0	100.00	111.00	5	146.0	34.9	2	X
5KP100A-HRA	5KP100CA-HRA	100.0	110.00	123.00	5	162.0	31.5	2	X
5KP110A-HRA	5KP110CA-HRA	110.0	122.00	135.00	5	177.0	28.8	2	X
5KP120A-HRA	5KP120CA-HRA	120.0	133.00	147.00	5	193.0	26.4	2	X
5KP130A-HRA	5KP130CA-HRA	130.0	144.00	159.00	5	209.0	24.4	2	X
5KP150A-HRA	5KP150CA-HRA	150.0	167.00	185.00	5	243.0	21.0	2	X
5KP160A-HRA	5KP160CA-HRA	160.0	178.00	197.00	5	259.0	19.7	2	X
5KP170A-HRA	5KP170CA-HRA	170.0	189.00	209.00	5	275.0	18.5	2	X
5KP180A-HRA	5KP180CA-HRA	180.0	200.00	221.00	5	292.0	17.5	2	X
5KP190A-HRA	5KP190CA-HRA	190.0	211.00	233.00	5	310.0	16.5	2	-
5KP200A-HRA	5KP200CA-HRA	200.0	222.00	246.00	5	329.2	15.5	2	X
5KP210A-HRA	5KP210CA-HRA	210.0	233.00	258.00	5	349.5	14.6	2	-
5KP220A-HRA	5KP220CA-HRA	220.0	244.00	270.00	5	371.1	13.7	2	X

5KP-HRA Series

Axial Leaded – 5 kW

Screen Process

100% Vision Inspection	MIL-STD-750 method 2074
100% High Temperature Storage Life (168hrs,175°C)	MIL-STD-750 method 1031
100% Temperature Cycle Test (-55 to 150°C, 20 cycles, dwell time 15 min)	MIL-STD-750 method 1051
100% Surge Test (2x)	MIL-STD-750 method 4066
100% HTRB 150°C Bias=VR(80% breakdown voltage, 96hrs, and each direction 96hrs for Bi-directional products)	MIL-STD-750 method 1038
Final Electrical Test(100% 3 sigma limit, 100% dynamic test and PAT limit)	MIL-STD-750 method 4016.4021.4011

Note: Up-screen program can be specified by customer's request via contacting Littelfuse service

I-V Curve Characteristics

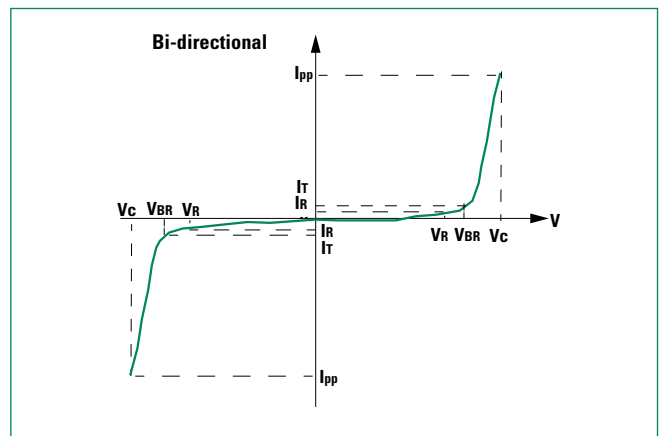
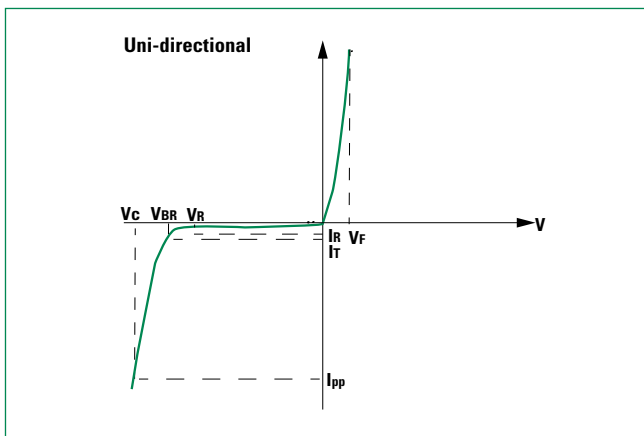

- P_{PPM}** Peak Pulse Power Dissipation – Max power dissipation
- V_R** Stand-off Voltage – Maximum voltage that can be applied to the TVS without operation
- V_{BR}** Breakdown Voltage – Maximum voltage that flows through the TVS at a specified test current (IT)
- V_C** Clamping Voltage – Peak voltage measured across the TVS at a specified Ippm (peak impulse current)
- I_R** Reverse Leakage Current – Current measured at V_R
- V_F** Forward Voltage Drop for Uni-directional

Ratings and Characteristic Curves (T_A=25°C unless otherwise noted)

Figure 1 - TVS Transients Clamping Waveform

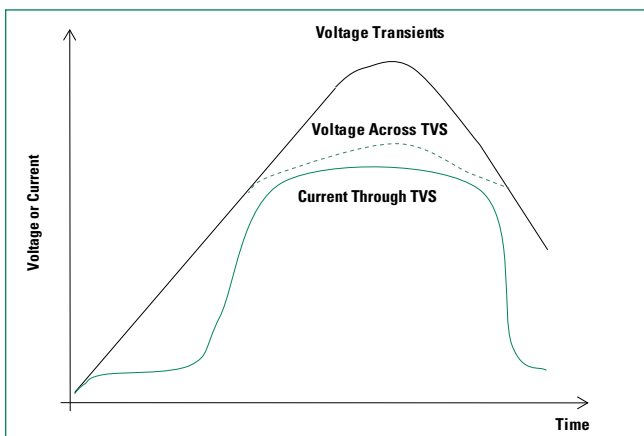
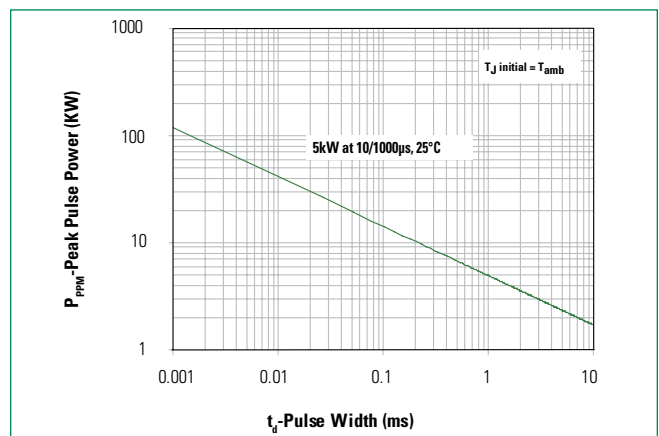

Figure 2 - Peak Pulse Power Rating Curve



5KP-HRA Series

Axial Leaded – 5 kW

Figure 3 - Peak Pulse Power Derating Curve

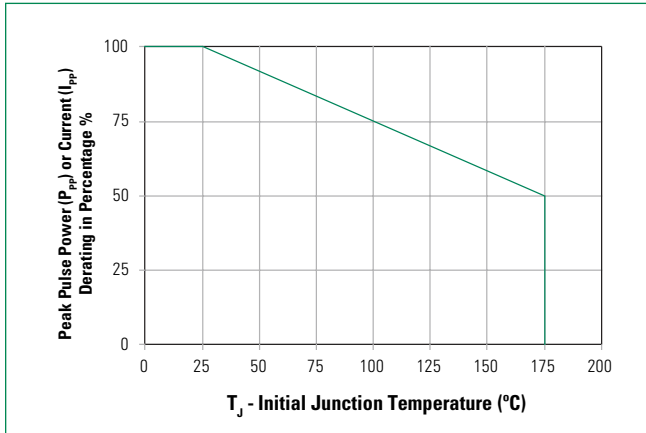

Figure 4 - Pulse Waveform

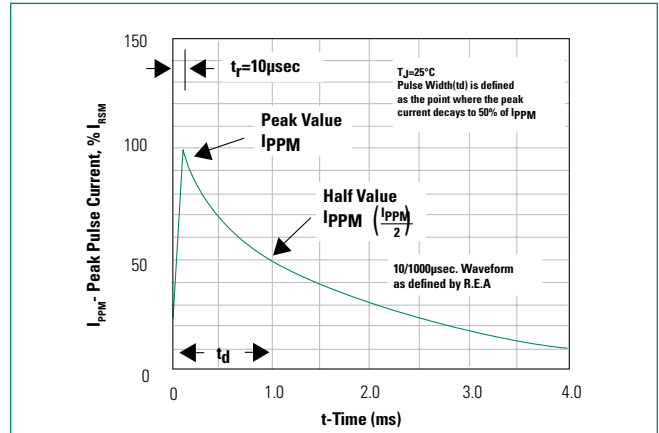

Figure 5 - Typical Junction Capacitance

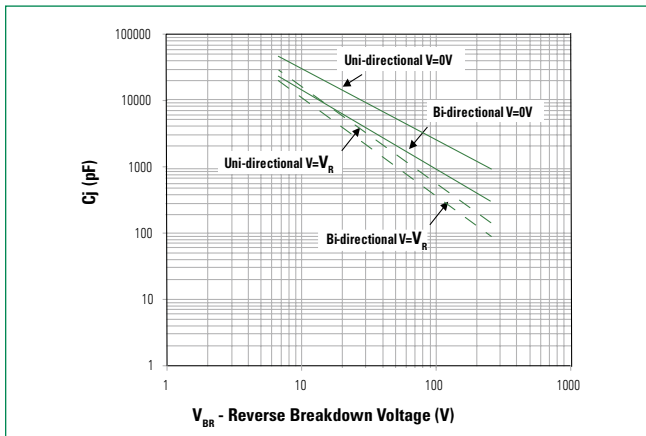

Figure 6 - Typical Transient Thermal Impedance

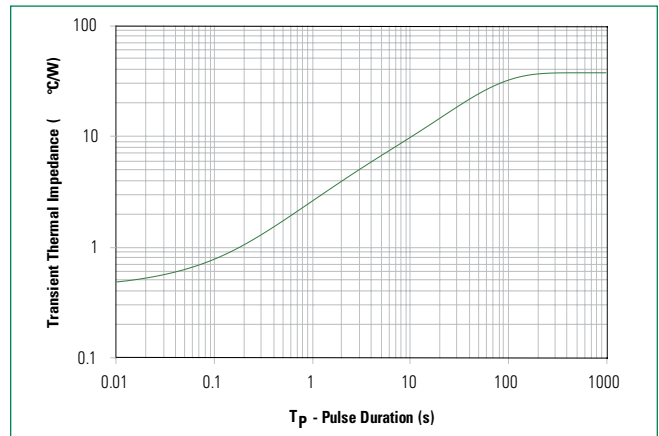

Figure 7 - Maximum Non-Repetitive Peak Forward Surge Current Uni-Directional Only

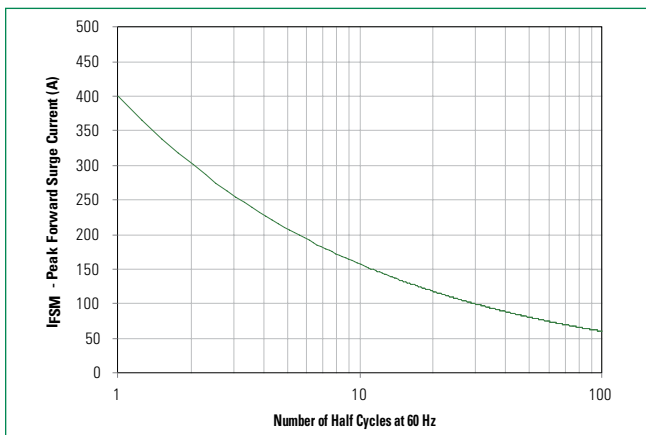
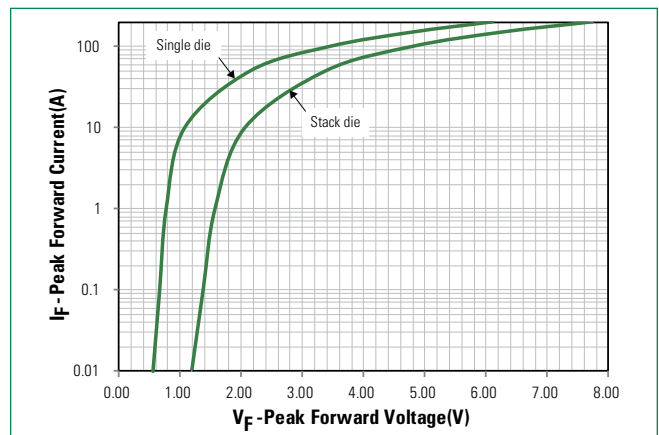

Figure 8 - Peak Forward Voltage Drop vs Peak Forward Current (Typical Values)



5KP-HRA Series

Axial Leaded – 5 kW

Physical Specifications

Weight	0.07oz., 2.1g
Case	P600 molded plastic body over passivated junction.
Polarity	Color band denotes the cathode except Bipolar.
Terminal	Matte Tin axial leads, solderable per JESD22-B102.

Environmental Specifications

High Temp. Storage	JESD22-A103
HTRB	JESD22-A108
Temperature Cycling	JESD22-A104
H3TRB	JESD22-A101
RSH	JESD22-B106

Dimensions

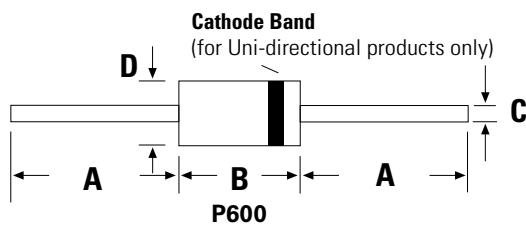

Dimensions	Inches		Millimeters	
	Min	Max	Min	Max
A	1.000	-	25.40	-
B	0.340	0.360	8.60	9.10
C	0.048	0.054	1.22	1.36
D	0.340	0.360	8.60	9.10

Part Numbering System

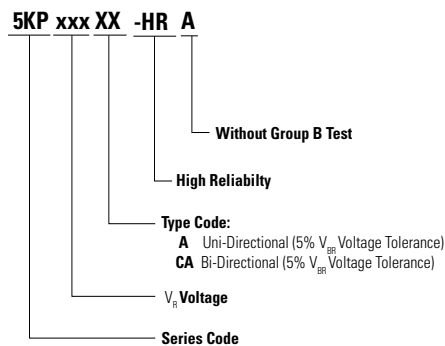

Part Marking System

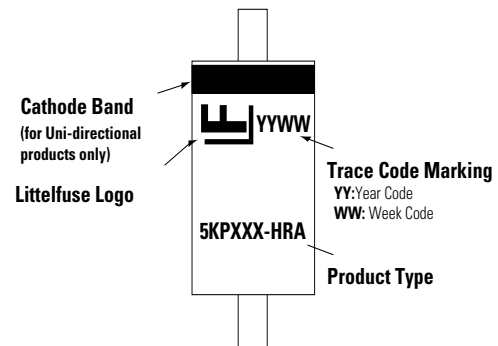

Packing Options

Part Number	Component Package	Quantity	Packaging Option	Packaging Specification
5KPxxxXX-HRA	P600	800	Tape & Reel	EIA STD RS-296

5KP-HRA Series

Axial Leaded – 5 kW

Tape and Reel Specification

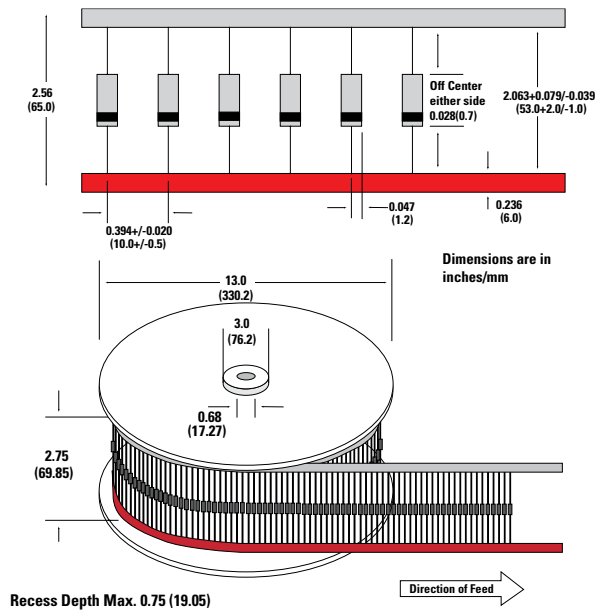

RTCA/DO-160G Wave 3

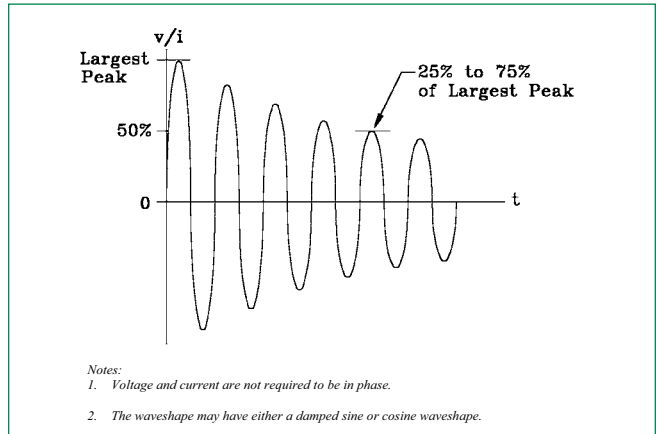

RTCA/DO-160G Wave 4 and Wave 5

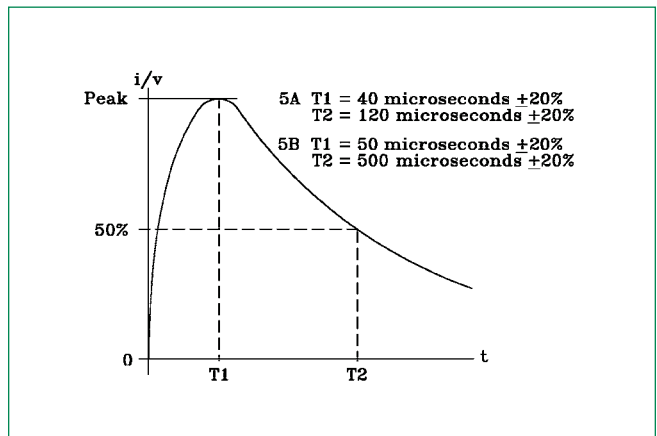
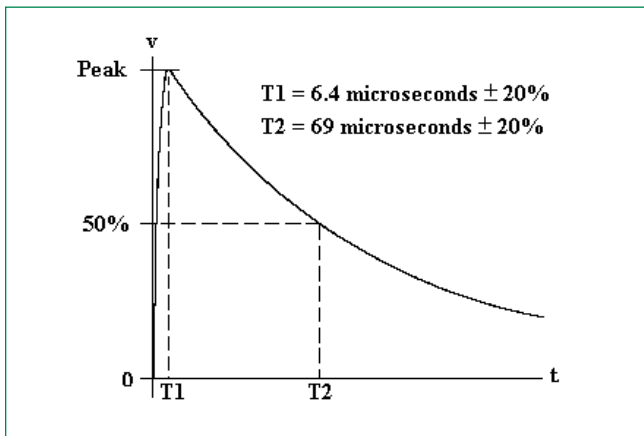

5KP-HRA Series

Axial Leaded – 5 kW

Pin Injection Protection Per RTCA/DO-160G

Part Number (Uni)	Part Number (Bi)	25C							70C							120C									
		Wave 3	Wave 4 (6.4/69us)				Wave 5a (40/120us)			Wave 3	Wave 4 (6.4/69us)				Wave 5a (40/120us)			Wave 3	Wave 4 (6.4/69us)				Wave 5a (40/120us)		
		L5	L3	L4	L5	L3	L4	L5	L5	L3	L4	L5	L3	L4	L5	L3	L4	L5	L3	L4	L5	L3	L4		
		128A	60A	150A	320A	300A	750A	1600A	128A	60A	150A	320A	300A	750A	128A	60A	150A	320A	300A	750A	128A	60A	150A	320A	300A
5KP5.0A-HRA	5KP5.0CA-HRA	pass	pass	pass	pass	pass	pass	pass	pass	pass	pass	pass	pass	pass	pass	pass	pass	pass	pass	pass	pass	pass	pass	pass	pass
5KP6.0A-HRA	5KP6.0CA-HRA	pass	pass	pass	pass	pass	pass	pass	pass	pass	pass	pass	pass	pass	pass	pass	pass	pass	pass	pass	pass	pass	pass	pass	pass
5KP6.5A-HRA	5KP6.5CA-HRA	pass	pass	pass	pass	pass	pass	pass	pass	pass	pass	pass	pass	pass	pass	pass	pass	pass	pass	pass	pass	pass	pass	pass	pass
5KP7.0A-HRA	5KP7.0CA-HRA	pass	pass	pass	pass	pass	pass	pass	pass	pass	pass	pass	pass	pass	pass	pass	pass	pass	pass	pass	pass	pass	pass	pass	pass
5KP7.5A-HRA	5KP7.5CA-HRA	pass	pass	pass	pass	pass	pass	pass	-	pass	pass	pass	pass	pass	pass	pass	pass	pass	pass	pass	pass	pass	pass	pass	pass
5KP8.0A-HRA	5KP8.0CA-HRA	pass	pass	pass	pass	pass	pass	pass	-	pass	pass	pass	pass	pass	pass	pass	pass	pass	pass	pass	pass	pass	pass	pass	pass
5KP8.5A-HRA	5KP8.5CA-HRA	pass	pass	pass	pass	pass	pass	pass	-	pass	pass	pass	pass	pass	pass	pass	pass	pass	pass	pass	pass	pass	pass	pass	pass
5KP9.0A-HRA	5KP9.0CA-HRA	pass	pass	pass	pass	pass	pass	pass	-	pass	pass	pass	pass	pass	pass	pass	pass	pass	pass	pass	pass	pass	pass	pass	pass
5KP10A-HRA	5KP10CA-HRA	pass	pass	pass	pass	pass	pass	pass	-	pass	pass	pass	pass	pass	pass	pass	pass	pass	pass	pass	pass	pass	pass	pass	pass
5KP11A-HRA	5KP11CA-HRA	pass	pass	pass	pass	pass	pass	pass	-	pass	pass	pass	pass	pass	pass	pass	pass	pass	pass	pass	pass	pass	pass	pass	pass
5KP12A-HRA	5KP12CA-HRA	pass	pass	pass	pass	pass	pass	pass	-	pass	pass	pass	pass	pass	pass	pass	pass	pass	pass	pass	pass	pass	pass	pass	-
5KP13A-HRA	5KP13CA-HRA	pass	pass	pass	pass	pass	pass	pass	-	pass	pass	pass	pass	pass	pass	pass	pass	pass	pass	pass	pass	pass	pass	pass	-
5KP14A-HRA	5KP14CA-HRA	pass	pass	pass	pass	pass	pass	pass	-	pass	pass	pass	pass	pass	pass	pass	pass	pass	pass	pass	pass	pass	pass	pass	-
5KP15A-HRA	5KP15CA-HRA	pass	pass	pass	pass	pass	pass	pass	-	pass	pass	pass	pass	pass	pass	pass	pass	pass	pass	pass	pass	pass	pass	pass	-
5KP16A-HRA	5KP16CA-HRA	pass	pass	pass	pass	pass	pass	-	-	pass	pass	pass	pass	pass	-	pass	pass	pass	pass	pass	pass	pass	pass	pass	-
5KP17A-HRA	5KP17CA-HRA	pass	pass	pass	pass	pass	pass	-	-	pass	pass	pass	pass	pass	-	pass	pass	pass	pass	pass	pass	pass	pass	pass	-
5KP18A-HRA	5KP18CA-HRA	pass	pass	pass	pass	pass	pass	-	-	pass	pass	pass	pass	pass	-	pass	pass	pass	pass	pass	pass	pass	pass	pass	-
5KP20A-HRA	5KP20CA-HRA	pass	pass	pass	pass	pass	pass	-	-	pass	pass	pass	pass	pass	-	pass	pass	pass	pass	pass	pass	pass	pass	pass	-
5KP22A-HRA	5KP22CA-HRA	pass	pass	pass	pass	pass	pass	-	-	pass	pass	pass	pass	pass	-	pass	pass	pass	pass	pass	pass	pass	pass	pass	-
5KP24A-HRA	5KP24CA-HRA	pass	pass	pass	pass	pass	pass	-	-	pass	pass	pass	pass	-	-	pass	pass	pass	pass	pass	pass	pass	pass	pass	-
5KP26A-HRA	5KP26CA-HRA	pass	pass	pass	pass	pass	pass	-	-	pass	pass	pass	pass	-	-	pass	pass	pass	pass	pass	pass	pass	pass	pass	-
5KP28A-HRA	5KP28CA-HRA	pass	pass	pass	pass	pass	pass	-	-	pass	pass	pass	pass	-	-	pass	pass	pass	pass	pass	pass	pass	pass	pass	-
5KP30A-HRA	5KP30CA-HRA	pass	pass	pass	pass	pass	pass	-	-	pass	pass	pass	pass	-	-	pass	pass	pass	pass	pass	pass	pass	pass	pass	-
5KP33A-HRA	5KP33CA-HRA	pass	pass	pass	pass	pass	-	-	-	pass	pass	pass	pass	pass	-	-	pass	pass	pass	pass	pass	pass	pass	pass	-
5KP36A-HRA	5KP36CA-HRA	pass	pass	pass	pass	pass	-	-	-	pass	pass	pass	pass	pass	-	-	pass	pass	pass	pass	pass	pass	pass	pass	-
5KP40A-HRA	5KP40CA-HRA	pass	pass	pass	pass	pass	-	-	-	pass	pass	pass	pass	pass	-	-	pass	pass	pass	pass	pass	pass	pass	pass	-
5KP43A-HRA	5KP43CA-HRA	pass	pass	pass	pass	pass	-	-	-	pass	pass	pass	pass	pass	-	-	pass	pass	pass	pass	pass	pass	pass	pass	-
5KP45A-HRA	5KP45CA-HRA	pass	pass	pass	pass	pass	-	-	-	pass	pass	pass	pass	pass	-	-	pass	pass	pass	pass	pass	pass	pass	pass	-
5KP48A-HRA	5KP48CA-HRA	pass	pass	pass	pass	pass	-	-	-	pass	pass	pass	pass	pass	-	-	pass	pass	pass	pass	pass	pass	pass	pass	-
5KP51A-HRA	5KP51CA-HRA	pass	pass	pass	pass	pass	-	-	-	pass	pass	pass	pass	pass	-	-	pass	pass	pass	pass	pass	pass	pass	pass	-
5KP54A-HRA	5KP54CA-HRA	pass	pass	pass	pass	pass	-	-	-	pass	pass	pass	pass	pass	-	-	pass	pass	pass	pass	pass	pass	pass	pass	-
5KP58A-HRA	5KP58CA-HRA	pass	pass	pass	pass	pass	-	-	-	pass	pass	pass	pass	pass	-	-	pass	pass	pass	pass	pass	pass	pass	pass	-
5KP60A-HRA	5KP60CA-HRA	pass	pass	pass	pass	pass	-	-	-	pass	pass	pass	pass	pass	-	-	pass	pass	pass	pass	pass	pass	pass	pass	-
5KP64A-HRA	5KP64CA-HRA	pass	pass	pass	pass	pass	-	-	-	pass	pass	pass	pass	pass	-	-	pass	pass	pass	pass	pass	pass	pass	pass	-
5KP70A-HRA	5KP70CA-HRA	pass	pass	pass	pass	pass	-	-	-	pass	pass	pass	pass	pass	-	-	pass	pass	pass	pass	pass	pass	pass	pass	-
5KP75A-HRA	5KP75CA-HRA	pass	pass	pass	pass	pass	-	-	-	pass	pass	pass	pass	pass	-	-	pass	pass	pass	pass	pass	pass	pass	pass	-
5KP78A-HRA	5KP78CA-HRA	pass	pass	pass	pass	pass	-	-	-	pass	pass	pass	pass	pass	-	-	pass	pass	pass	pass	pass	pass	pass	pass	-
5KP85A-HRA	5KP85CA-HRA	pass	pass	pass	pass	pass	-	-	-	pass	pass	pass	pass	pass	-	-	pass	pass	pass	pass	pass	pass	pass	pass	-
5KP90A-HRA	5KP90CA-HRA	pass	pass	pass	pass	pass	-	-	-	pass	pass	pass	pass	pass	-	-	pass	pass	pass	pass	pass	pass	pass	pass	-
5KP100A-HRA	5KP100CA-HRA	pass	pass	pass	pass	pass	-	-	-	pass	pass	pass	pass	pass	-	-	pass	pass	pass	pass	pass	pass	pass	pass	-
5KP110A-HRA	5KP110CA-HRA	pass	pass	pass	pass	pass	-	-	-	pass	pass	pass	pass	pass	-	-	pass	pass	pass	pass	pass	pass	pass	pass	-
5KP120A-HRA	5KP120CA-HRA	pass	pass	pass	pass	pass	-	-	-	pass	pass	pass	pass	pass	-	-	pass	pass	pass	pass	pass	pass	pass	pass	-
5KP130A-HRA	5KP130CA-HRA	pass	pass	pass	pass	pass	-	-	-	pass	pass	pass	pass	pass	-	-	pass	pass	pass	pass	pass	pass	pass	pass	-
5KP150A-HRA	5KP150CA-HRA	pass	pass	pass	pass	pass	-	-	-	pass	pass	pass	pass	pass	-	-	pass	pass	pass	pass	pass	pass	pass	pass	-
5KP160A-HRA	5KP160CA-HRA	pass	pass	pass	pass	pass	-	-	-	pass	pass	pass	pass	pass	-	-	pass	pass	pass	pass	pass	pass	pass	pass	-
5KP170A-HRA	5KP170CA-HRA	pass	pass	pass	pass	pass	-	-	-	pass	pass	pass	pass	pass	-	-	pass	pass	pass	pass	pass	pass	pass	pass	-
5KP180A-HRA	5KP180CA-HRA	pass	pass	pass	pass	pass	-	-	-	pass	pass	pass	pass	pass	-	-	pass	pass	pass	pass	pass	pass	pass	pass	-
5KP190A-HRA	5KP190CA-HRA	pass	pass	pass	pass	pass	-	-	-	pass	pass	pass	pass	pass	-	-	pass	pass	pass	pass	pass	pass	pass	pass	-
5KP200A-HRA	5KP200CA-HRA	pass	pass	pass	pass	pass	-	-	-	pass	pass	pass	pass	pass	-	-	pass	pass	pass	pass	pass	pass	pass	pass	-
5KP210A-HRA	5KP210CA-HRA	pass	pass	pass	pass	pass	-	-	-	pass	pass	pass	pass	pass	-	-	pass	pass	pass	pass	pass	pass	pass	pass	-
5KP220A-HRA	5KP220CA-HRA	pass	pass	pass	pass	pass	-	-	-	pass	pass	pass	pass	pass	-	-	pass	pass	pass	pass	pass	pass	pass	pass	-

Note: 1. L1 = Level 1, L2 = Level 2, L3 = Level 3, L4 = Level 4, L5 = Level 5

Disclaimer Notice - Information furnished is believed to be accurate and reliable. However, users should independently evaluate the suitability of and test each product selected for their own applications. Littelfuse products are not designed for, and may not be used in, all applications. Read complete Disclaimer Notice at: www.littelfuse.com/disclaimer-electronics.