

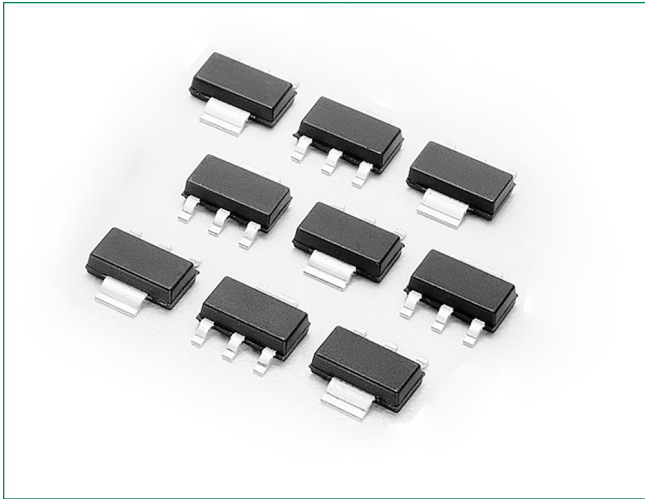

# MAC08BT1, MAC08MT1



## Description

Designed for high volume, low cost, industrial and consumer applications such as motor control; process control; temperature, light and speed control.

## Features

- Sensitive Gate Trigger Current in Four Trigger Modes
- Blocking Voltage to 600 Volts
- Glass Passivated Surface for Reliability and Uniformity
- Surface Mount Package
- Pb-Free Packages are Available

## Pin Out

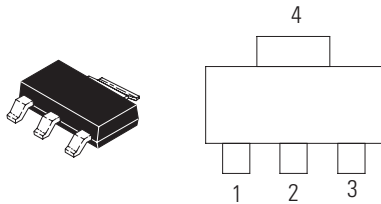

## Functional Diagram

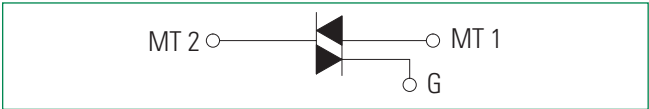

## Additional Information



Resources



Accessories

### Maximum Ratings ( $T_J = 25^\circ\text{C}$ unless otherwise noted)

Rating	Symbol	Value	Unit
Peak Repetitive Off-State Voltage (Note 1) (Gate Open, Sine Wave 50 to 60 Hz, $T_J = -40^\circ$ to $110^\circ\text{C}$ )	$V_{\text{DRM}}$ $V_{\text{RRM}}$	200 600	V
On-State RMS Current (Full Cycle Sine Wave, 60 Hz, $T_C = 80^\circ\text{C}$ )	$I_{\text{T (RMS)}}$	0.8	A
Peak Non-Repetitive Surge Current (One Full Cycle Sine Wave, 60 Hz, $T_C = 25^\circ\text{C}$ )	$I_{\text{TSM}}$	8.0	A
Circuit Fusing Consideration ( $t = 8.3$ msec)	$I^2t$	0.4	A <sup>2</sup> sec
Peak Gate Power (Pulse Width $\leq 10$ $\mu\text{sec}$ , $T_C = 80^\circ\text{C}$ )	$P_{\text{GM}}$	5.0	W
Average Gate Power ( $t = 8.3$ msec, $T_C = 80^\circ\text{C}$ )	$P_{\text{G(AV)}}$	0.1	W
Operating Junction Temperature Range	$T_J$	-40 to +110	$^\circ\text{C}$
Storage Temperature Range	$T_{\text{stg}}$	-40 to +150	$^\circ\text{C}$

Stresses exceeding Maximum Ratings may damage the device. Maximum Ratings are stress ratings only. Functional operation above the Recommended Operating Conditions is not implied. Extended exposure to stresses above the Recommended Operating Conditions may affect device reliability.

- $V_{\text{DRM}}$  and  $V_{\text{RRM}}$  for all types can be applied on a continuous basis. Ratings apply for zero or negative gate voltage; however, positive gate voltage shall not be applied concurrent with negative potential on the anode. Blocking voltages shall not be tested with a constant current source such that the voltage ratings of the devices are exceeded.

### Thermal Characteristics

Rating	Symbol	Value	Unit
Thermal Resistance, Junction-to-Ambient PCB Mounted per Figure 1	$R_{\theta\text{JA}}$	156	$^\circ\text{C/W}$

- These ratings are applicable when surface mounted on the minimum pad sizes recommended.
- 1/8" from case for 10 seconds.

### Electrical Characteristics - OFF ( $T_C = 25^\circ\text{C}$ unless otherwise noted)

Characteristic	Symbol	Min	Typ	Max	Unit	
†Peak Repetitive Blocking Current ( $V_{\text{AK}} = V_{\text{DRM}} = V_{\text{RRM}}$ ; Gate Open)	$I_{\text{DRM}}$ $I_{\text{RRM}}$	$T_J = 25^\circ\text{C}$	-	-	10	$\mu\text{A}$
		$T_J = 110^\circ\text{C}$	-	-	200	mA

### Electrical Characteristics - ON ( $T_C = 25^\circ\text{C}$ unless otherwise noted; Electricals apply in both directions)

Characteristic	Symbol	Min	Typ	Max	Unit
Peak On-State Voltage (Note 2) ( $I_{\text{TM}} = \pm 1.1$ A)	$V_{\text{TM}}$	-	-	1.9	V
Gate Trigger Current (Continuous dc) ( $V_D = 12$ V, $R_L = 100$ $\Omega$ )	$I_{\text{GT}}$	-	-	10	mA
Holding Current ( $V_D = 12$ V, Gate Open, Initiating Current = $\pm 20$ mA)	$I_{\text{H}}$	-	-	5.0	mA
Gate Trigger Voltage (Continuous dc) ( $V_D = 12$ V, $R_L = 100$ $\Omega$ )	$V_{\text{GT}}$	-	-	2.0	V

- Pulse Test: Pulse Width  $\leq 2.0$  ms, Duty Cycle  $\leq 2\%$ .

### Dynamic Characteristics

Characteristic	Symbol	Min	Typ	Max	Unit
Critical Rate of Rise of Commutation Voltage ( $f = 250$ Hz, $I_{\text{TM}} = 1.0$ A, Commutating $di/dt = 1.5$ A/mS On-State Current Duration = 2.0 mS, $V_{\text{DRM}} = 200$ V, Gate Unenergized, $T_C = 110^\circ\text{C}$ , Gate Source Resistance = 150 $\Omega$ , See Figure 10)	( $di/dt$ )c	1.5	-	-	A/ms
Critical Rate of Rise of Off-State Voltage ( $V_D = 0.67 \times V_{\text{DRM}}$ , Exponential Waveform, Gate Open, $T_J = 110^\circ\text{C}$ )	dV/dt	10	-	-	V/ $\mu\text{s}$

**Voltage Current Characteristic of SCR**

Symbol	Parameter
$V_{DRM}$	Peak Repetitive Forward Off State Voltage
$I_{DRM}$	Peak Forward Blocking Current
$V_{RRM}$	Peak Repetitive Reverse Off State Voltage
$I_{RRM}$	Peak Reverse Blocking Current
$V_{TM}$	Maximum On State Voltage
$I_H$	Holding Current

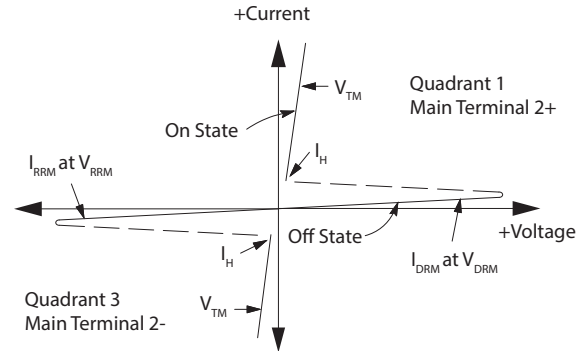

**Quadrant Definitions for a Triac**

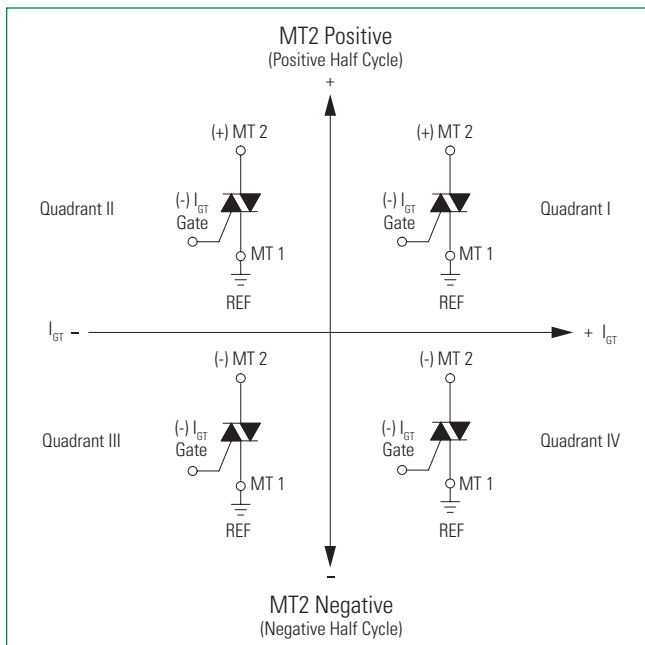

All Polarities are referenced to MT1.  
With in-phase signals (using standard AC lines) quadrants I and III are used

**Figure 1. PCB for Thermal Impedance and Power Testing of SOT-223**

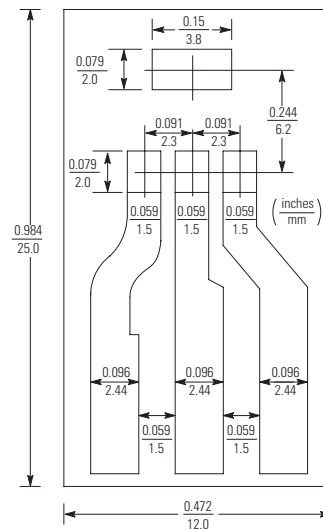

**BOARD MOUNTED VERTICALLY IN CINCH 8840 EDGE CONNECTOR.  
BOARD THICKNESS = 65 MIL., FOIL THICKNESS = 2.5 MIL.  
MATERIAL: G10 FIBERGLASS BASE EPOXY**

**Figure 2. On-State Characteristics**

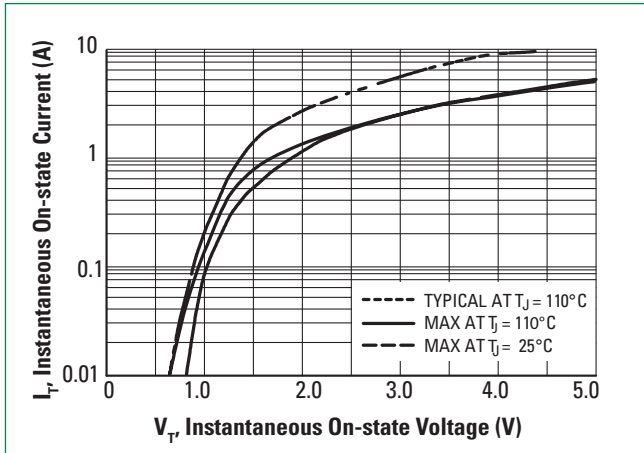

**Figure 3. Junction to Ambient Thermal Resistance vs. Copper Tab Area**

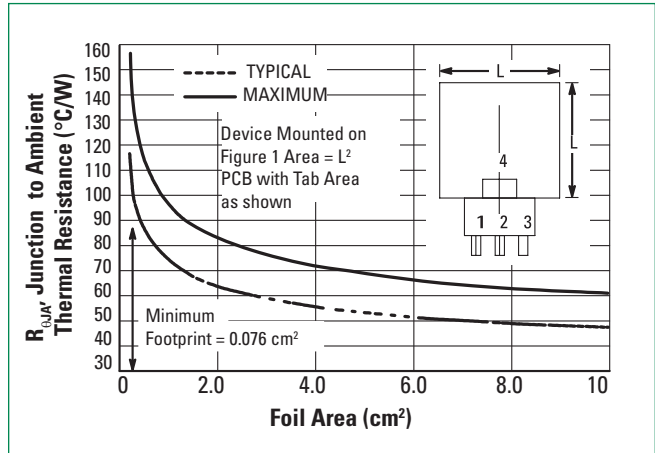

**Figure 4. Current Derating, Minimum Pad Size Reference: Ambient Temperature**

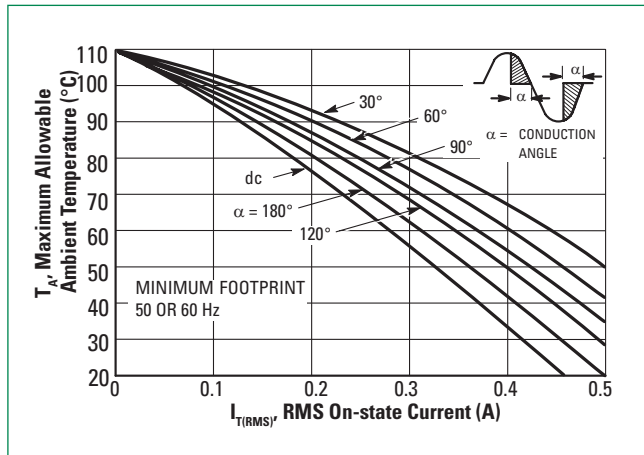

**Figure 5. Current Derating, 1.0 cm Square Pad Reference: Ambient Temperature**

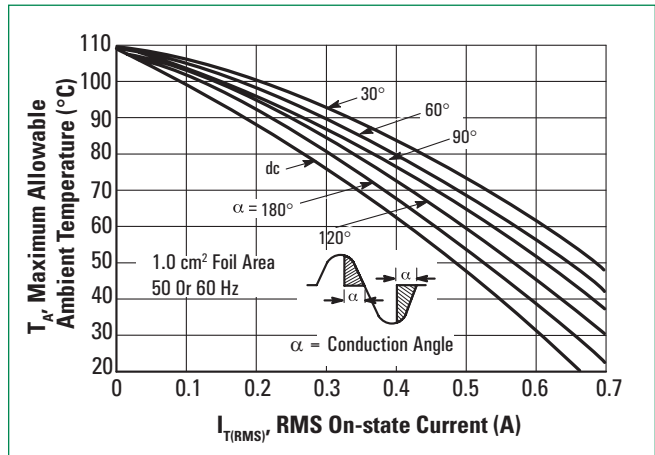

**Figure 6. Current Derating, 2.0 cm Square Pad Reference: Ambient Temperature**

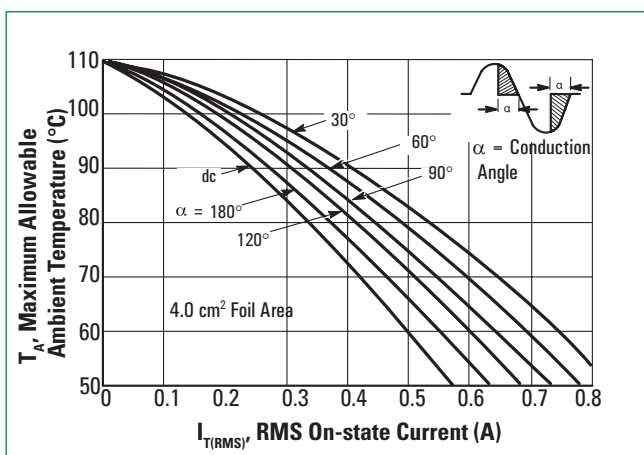

**Figure 7. Current Derating Reference: MT2 Tab**

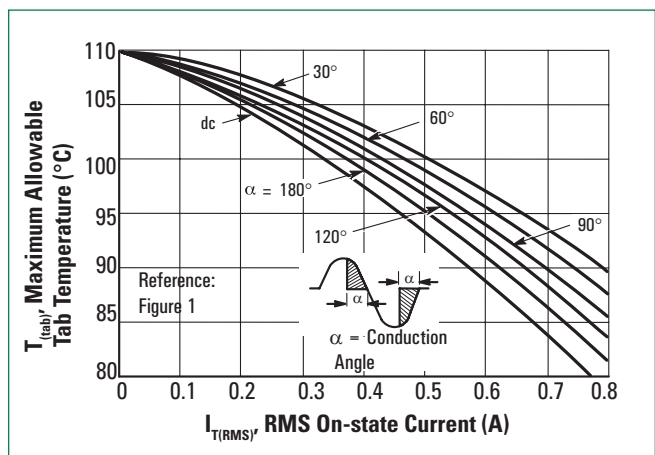

Figure 8. Power Dissipation

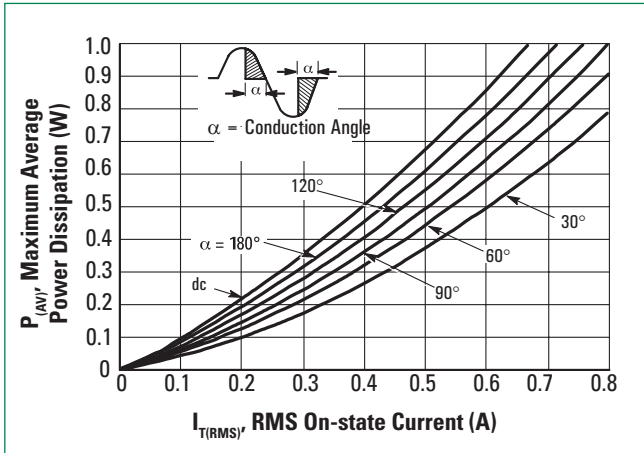

Figure 9. Thermal Response, Device Mounted on Figure 1 Printed Circuit Board

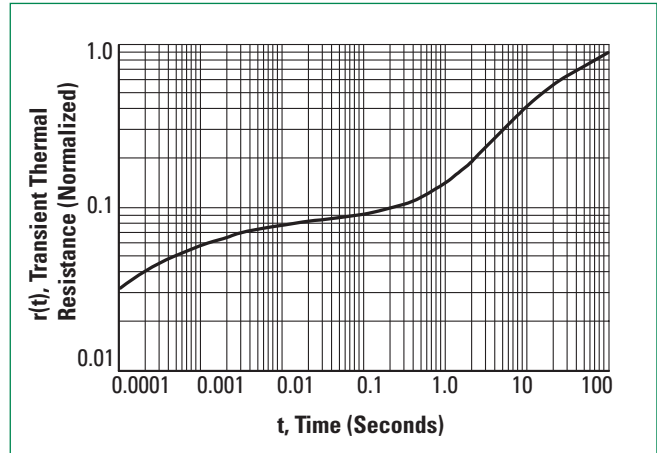

Figure 10. Simplified Test Circuit to Measure the Critical Rate of Rise of Commutating Current ( $di/dt$ )

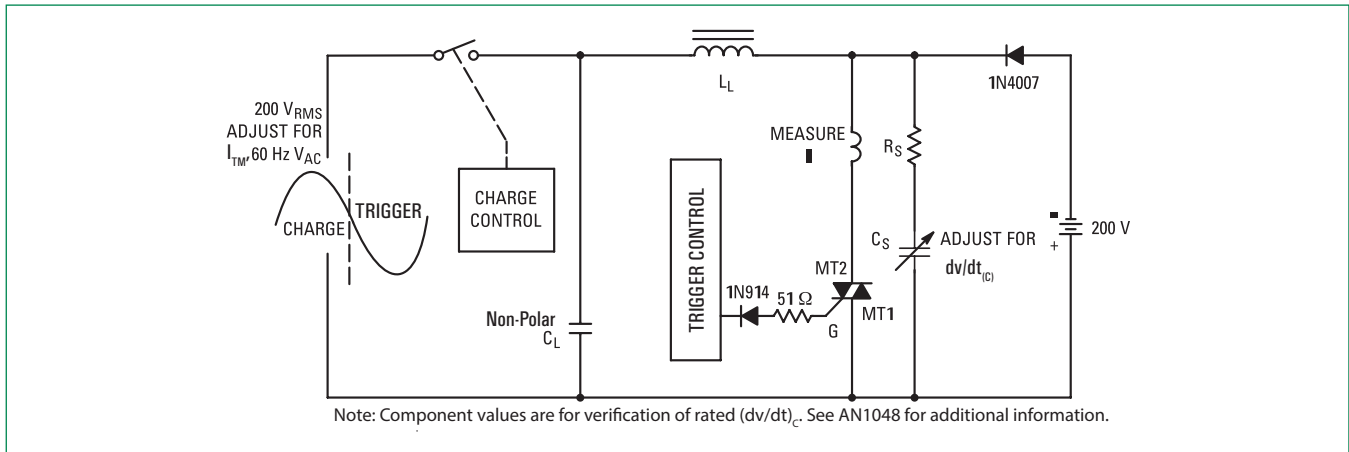

Figure 11. Typical Commutating  $dv/dt$  versus Current Crossing Rate and Junction Temperature

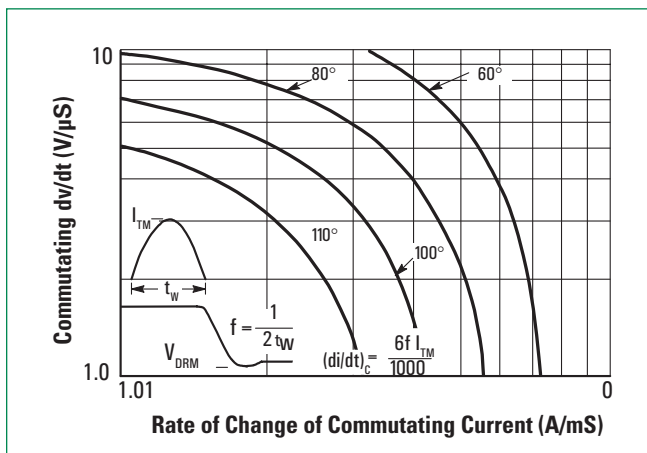
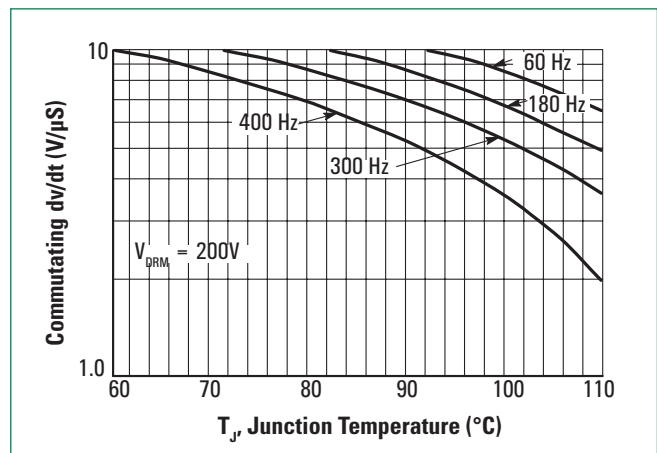
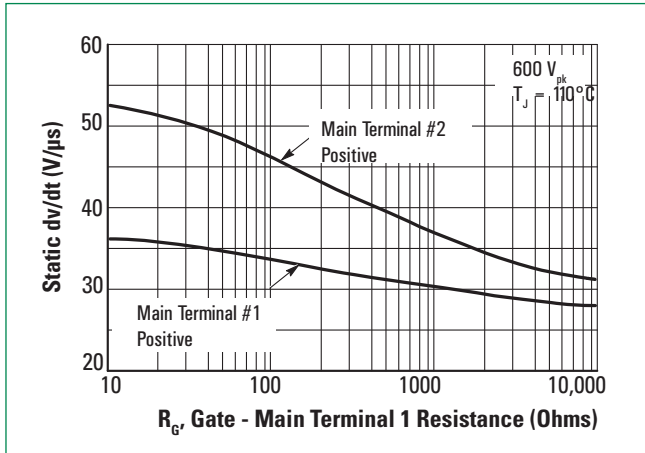

Figure 12. Typical Commutating  $dv/dt$  versus Junction Temperature at 0.8 Amps RMS



**Figure 13. Exponential Static dv/dt versus Gate – Main Terminal 1 Resistance**



**Figure 14. Typical Gate Trigger Current Variation**

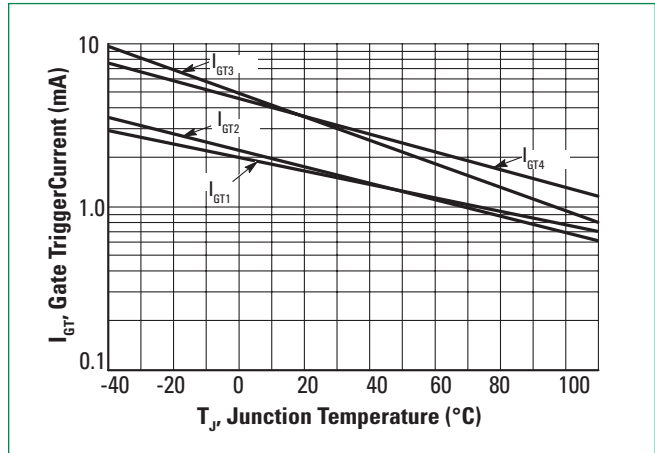

**Figure 15. Typical Holding Current Variation**

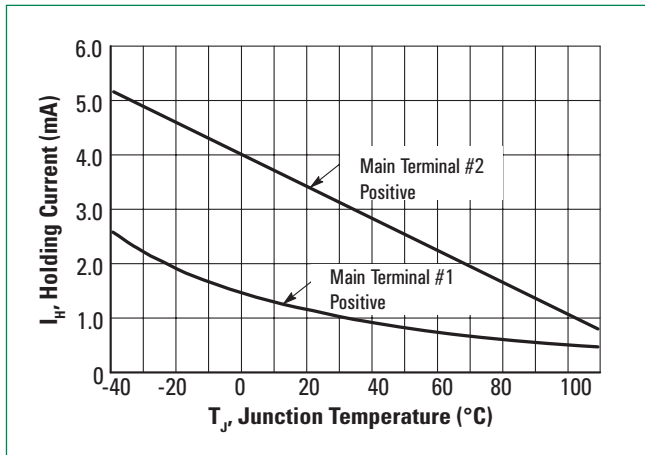

**Figure 16. Gate Trigger Voltage Variation**

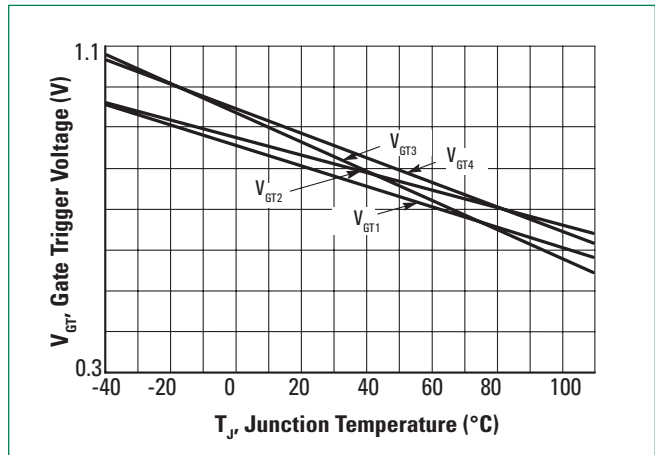

### Dimensions

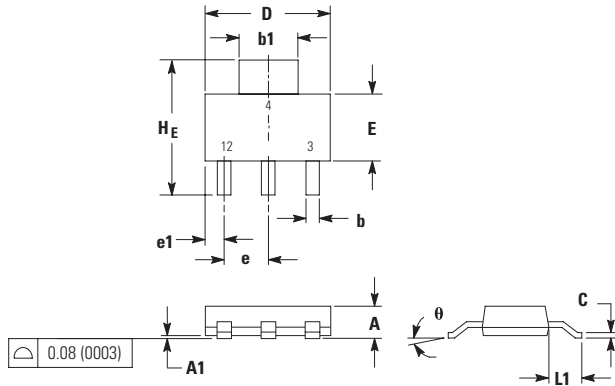

Dim	Inches			Millimeters		
	Min	Nom	Max	Min	Nom	Max
A	---	---	0.071	---	---	1.80
A1	0.001	0.003	0.005	0.02	0.07	0.13
b	0.026	0.030	0.033	0.66	0.75	0.84
b1	0.114	0.118	0.122	2.90	3.00	3.10
c	0.009	0.011	0.014	0.23	0.29	0.35
D	0.260	0.260	0.264	6.60	6.60	6.71
E	0.130	0.138	0.146	3.30	3.50	3.70
e	---	0.091	---	---	2.30	---
e1	0.030	0.037	0.045	0.75	0.95	1.15
L1	0.059	0.069	0.079	1.50	1.75	2.00
HE	0.264	0.276	0.287	6.7	7.00	7.3
θ	0°	---	10°	0°	---	10°

1. DIMENSIONING AND TOLERANCING PER ANSI Y14.5M, 1982.  
2. CONTROLLING DIMENSION: INCH.

Pin Assignment	
1	Main Terminal 1
2	Main Terminal 2
3	Gate
4	Main Terminal 2

### Part Marking System



**SOT-223  
Case 318E  
Style 11**

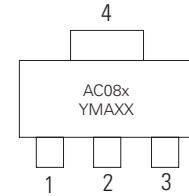

AC08X = Device Code  
x = D, M, or N  
Y = Year  
M = Month  
A = Assembly Site  
XX = Lot Serial Code  
G = Pb-Free Package

### Soldering Footprint

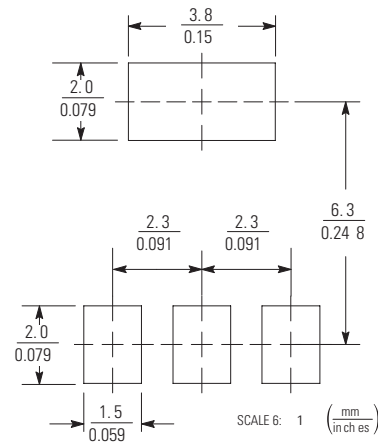

### Ordering Information

Device	Package Type	Shipping
MAC08BT1	SOT-223	1000 / Tape & Reel
MAC08BT1G	SOT-223 (Pb-Free)	1000 / Tape & Reel
MAC08MT1	SOT-223	1000 / Tape & Reel
MAC08MT1G	SOT-223 (Pb-Free)	1000 / Tape & Reel

**Disclaimer Notice** - Information furnished is believed to be accurate and reliable. However, users should independently evaluate the suitability of and test each product selected for their own applications. Littelfuse products are not designed for, and may not be used in, all applications. Read complete Disclaimer Notice at: [www.littelfuse.com/disclaimer-electronics](http://www.littelfuse.com/disclaimer-electronics)