

1.5SMC Series

Surface Mount – 1500W



Additional Information



Resources



Accessories



Samples

Agency Approvals

Agency	Agency File Number
	E230531

Maximum Ratings and Thermal Characteristics ($T_A=25^{\circ}\text{C}$ unless otherwise noted)

Parameter	Symbol	Value	Unit
Peak Pulse Power Dissipation(Fig.2) by 10/1000us Test Waveform(Fig.4) (Note 1),(Note 2) -Single Die Parts ¹	P_{PPM}	1500	W
Peak Pulse Power Dissipation(Fig.2) by 10/1000us Test Waveform(Fig.4) (Note 1), (Note 2)-Stacked Die Parts (Note 5)	P_{PPM}	2000	W
Power Dissipation on Infinite Heat Sink at $T_L=50^{\circ}\text{C}$	P_D	6.5	W
Peak Forward Surge Current, 8.3ms Single Half Sine Wave (Note 3)	I_{FSM}	200	A
Maximum Instantaneous Forward Voltage at 100A for Unidirectional Only (Note 4)	V_F	3.5/5.0	V
Operating Temperature Range	T_J	-65 to 150	$^{\circ}\text{C}$
Storage Temperature Range	T_{STG}	-65 to 175	$^{\circ}\text{C}$
Typical Thermal Resistance Junction to Lead	$R_{\theta JL}$	15	$^{\circ}\text{C}/\text{W}$
Typical Thermal Resistance Junction to Ambient	$R_{\theta JA}$	75	$^{\circ}\text{C}/\text{W}$

Notes:

- Non-repetitive current pulse, per Fig. 4 and derated above T_J (initial) = 25°C per Fig. 3.
- Mounted on copper pad area of 0.31x0.31" (8.0 x 8.0mm) to each terminal.
- Measured on 8.3ms single half sine wave or equivalent square wave for unidirectional device only, duty cycle=4 per minute maximum.
- $V_F < 3.5\text{V}$ for single die parts and $V_F < 5.0\text{V}$ for stacked-die parts.
- For stacked die component details, please refer to part numbers labeled by * in Electrical Characteristics.

Description

The 1.5SMC series is designed specifically to protect sensitive electronic equipment from voltage transients induced by lightning and other transient voltage events.

Features & Benefits

- 1500W peak pulse power capability at 10/1000us waveform, repetition rate (duty cycles):0.01%
- Excellent clamping capability
- Low incremental surge resistance
- Typical I_R less than 1 μA when $V_{BR\ min} > 12\text{V}$
- For surface mounted applications to optimize board space
- Low profile package
- Built-in strain relief
- Typical failure mode is short from over-specified voltage or current
- Whisker test is conducted based on JEDEC JESD201A per its table 4a and 4c
- IEC 61000-4-2 ESD 30kV(Air), 30kV (Contact)
- ESD protection of data lines in accordance with IEC 61000-4-2
- EFT protection of data lines in accordance with IEC 61000-4-4
- Fast response time: typically less than 1.0ps from 0V to BV min
- Glass passivated chip junction
- High temperature to reflow soldering guaranteed: 260 $^{\circ}\text{C}/30\text{sec}$
- $V_{BR} @ T_J = V_{BR} @ 25^{\circ}\text{C} \times (1 + \alpha_T \times (T_J - 25))$ (α_T : Temperature Coefficient, typical value is 0.1%)
- Plastic package is flammability rated V-0 per Underwriters Laboratories
- Meet MSL level1, per J-STD-020, LF maximum peak of 260 $^{\circ}\text{C}$
- Matte tin lead-free plated
- Halogen free and RoHS compliant
- Pb-free E3 means 2nd level interconnect is Pb-free and the terminal finish material is tin(Sn) (IPC/JEDEC J-STD-609A.01)

Applications

TVS devices are ideal for the protection of I/O Interfaces, V_{CC} bus and other vulnerable circuits used in Telecom, Computer, Industrial and Consumer electronic applications.

Functional Diagram



Bi-directional



Uni-directional

1.5SMC Series

Surface Mount – 1500W

Electrical Characteristics ($T_A=25^\circ\text{C}$ unless otherwise noted)

Part Number (Uni)	Part Number (Bi)	Marking		Reverse Stand off Voltage V_R (Volts)	Breakdown Voltage V_{BR} (Volts) @ I_T		Test Current I_T (mA)	Maximum Clamping Voltage V_C @ I_{pp} (V)	Maximum Peak Pulse Current I_{pp} (A)	Maximum Reverse Leakage I_R @ V_R (μA)	Agency Approval
		Uni	Bi		Min	Max					
1.5SMC6.8A	1.5SMC6.8CA	6V8A	6V8C	5.80	6.45	7.14	10	10.5	144.8	1000	X
1.5SMC7.5A	1.5SMC7.5CA	7V5A	7V5C	6.40	7.13	7.88	10	11.3	134.5	500	X
1.5SMC8.2A	1.5SMC8.2CA	8V2A	8V2C	7.02	7.79	8.61	10	12.1	125.6	200	X
1.5SMC9.1A	1.5SMC9.1CA	9V1A	9V1C	7.78	8.65	9.50	1	13.4	113.4	50	X
1.5SMC10A	1.5SMC10CA	10A	10C	8.55	9.50	10.50	1	14.5	104.8	10	X
1.5SMC11A	1.5SMC11CA	11A	11C	9.40	10.50	11.60	1	15.6	97.4	5	X
1.5SMC12A	1.5SMC12CA	12A	12C	10.20	11.40	12.60	1	16.7	91.0	5	X
1.5SMC13A	1.5SMC13CA	13A	13C	11.10	12.40	13.70	1	18.2	83.5	1	X
1.5SMC15A	1.5SMC15CA	15A	15C	12.80	14.30	15.80	1	21.2	71.7	1	X
1.5SMC16A	1.5SMC16CA	16A	16C	13.60	15.20	16.80	1	22.5	67.6	1	X
1.5SMC18A	1.5SMC18CA	18A	18C	15.30	17.10	18.90	1	25.2	60.3	1	X
1.5SMC20A	1.5SMC20CA	20A	20C	17.10	19.00	21.00	1	27.7	54.9	1	X
1.5SMC22A	1.5SMC22CA	22A	22C	18.80	20.90	23.10	1	30.6	49.7	1	X
1.5SMC24A	1.5SMC24CA	24A	24C	20.50	22.80	25.20	1	33.2	45.8	1	X
1.5SMC27A	1.5SMC27CA	27A	27C	23.10	25.70	28.40	1	37.5	40.5	1	X
1.5SMC30A	1.5SMC30CA	30A	30C	25.60	28.50	31.50	1	41.4	36.7	1	X
1.5SMC33A	1.5SMC33CA	33A	33C	28.20	31.40	34.70	1	45.7	33.3	1	X
1.5SMC36A	1.5SMC36CA	36A	36C	30.80	34.20	37.80	1	49.9	30.5	1	X
1.5SMC39A	1.5SMC39CA	39A	39C	33.30	37.10	41.00	1	53.9	28.2	1	X
1.5SMC43A	1.5SMC43CA	43A	43C	36.80	40.90	45.20	1	59.3	25.6	1	X
1.5SMC47A	1.5SMC47CA	47A	47C	40.20	44.70	49.40	1	64.8	23.5	1	X
1.5SMC51A	1.5SMC51CA	51A	51C	43.60	48.50	53.60	1	70.1	21.7	1	X
1.5SMC56A	1.5SMC56CA	56A	56C	47.80	53.20	58.80	1	77.0	19.7	1	X
1.5SMC62A	1.5SMC62CA	62A	62C	53.00	58.90	65.10	1	85.0	17.9	1	X
1.5SMC68A	1.5SMC68CA	68A	68C	58.10	64.60	71.40	1	92.0	16.5	1	X
1.5SMC75A	1.5SMC75CA	75A	75C	64.10	71.30	78.80	1	103.0	14.8	1	X
1.5SMC82A	1.5SMC82CA	82A	82C	70.10	77.90	86.10	1	113.0	13.5	1	X
1.5SMC91A	1.5SMC91CA	91A	91C	77.80	86.50	95.50	1	125.0	12.2	1	X
1.5SMC100A	1.5SMC100CA	100A	100C	85.50	95.00	105.00	1	137.0	11.1	1	X
1.5SMC110A	1.5SMC110CA	110A	110C	94.00	105.00	116.00	1	152.0	10.0	1	X
1.5SMC120A	1.5SMC120CA	120A	120C	102.00	114.00	126.00	1	165.0	9.2	1	X
1.5SMC130A	1.5SMC130CA	130A	130C	111.00	124.00	137.00	1	179.0	8.5	1	X
1.5SMC150A	1.5SMC150CA	150A	150C	128.00	143.00	158.00	1	207.0	7.3	1	X
1.5SMC160A	1.5SMC160CA	160A	160C	136.00	152.00	168.00	1	219.0	6.9	1	X
1.5SMC170A	1.5SMC170CA	170A	170C	145.00	162.00	179.00	1	234.0	6.5	1	X
1.5SMC180A	1.5SMC180CA	180A	180C	154.00	171.00	189.00	1	246.0	6.2	1	X
1.5SMC200A	1.5SMC200CA	200A	200C	171.00	190.00	210.00	1	274.0	5.5	1	X
1.5SMC220A	1.5SMC220CA	220A	220C	185.00	209.00	231.00	1	328.0	4.6	1	X
1.5SMC250A	1.5SMC250CA	250A	250C	214.00	237.00	263.00	1	344.0	4.4	1	X
1.5SMC300A	1.5SMC300CA	300A	300C	256.00	285.00	315.00	1	414.0	3.7	1	X
1.5SMC350A*	1.5SMC350CA*	350A	350C	300.00	332.00	368.00	1	482.0	4.2	1	X
1.5SMC400A*	1.5SMC400CA*	400A	400C	342.00	380.00	420.00	1	548.0	3.7	1	X
1.5SMC440A*	1.5SMC440CA*	440A	440C	376.00	418.00	462.00	1	602.0	3.4	1	X
1.5SMC480A*	1.5SMC480CA*	480A	480C	408.00	456.00	504.00	1	658.0	3.1	1	X
1.5SMC510A*	1.5SMC510CA*	510A	510C	434.00	485.00	535.00	1	698.0	2.9	1	X
1.5SMC530A*	1.5SMC530CA*	530A	530C	451.00	503.50	556.50	1	725.0	2.8	1	X
1.5SMC540A*	1.5SMC540CA*	540A	540C	460.00	513.00	567.00	1	740.0	2.8	1	X
1.5SMC550A*	1.5SMC550CA*	550A	550C	468.00	522.50	577.50	1	760.0	2.7	1	X
1.5SMC600A*	1.5SMC600CA*	600A	600C	512.00	570.00	630.00	1	828.0	2.5	1	-
1.5SMC650A*	-	650A	-	553.00	618.00	682.00	1	897.0	2.3	1	-

For bidirectional type having V_s of 10 volts and less, the I_s limit is double.

For parts without A, the V_{BR} is $\pm 10\%$ and V_C is 5% higher than with A parts, the parts without A are currently available, but not recommended for new designs. The parts with A are preferred.

For stack-die parts, use * to label the part number.

1.5SMC Series

Surface Mount – 1500W

I-V Curve Characteristics

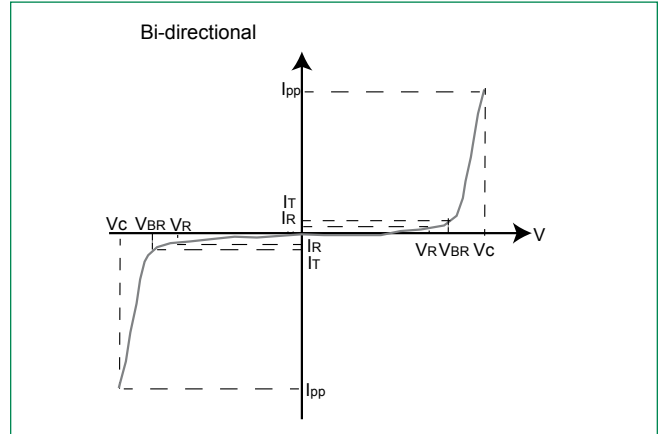
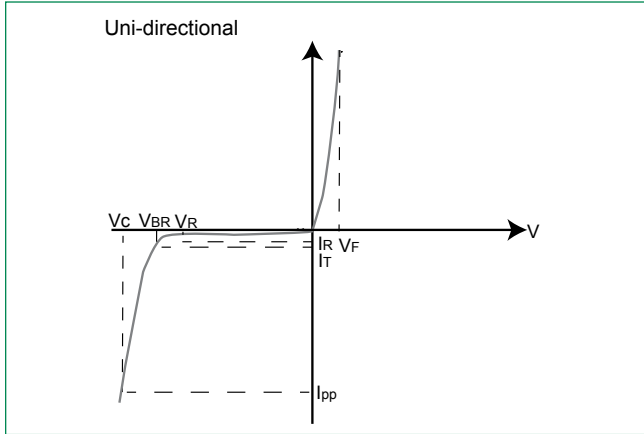

- P_{PPM} Peak Pulse Power Dissipation** -- Max power dissipation
- V_R Stand-off Voltage** -- Maximum voltage that can be applied to the TVS without operation
- V_{BR} Breakdown Voltage** -- Maximum voltage that flows though the TVS at a specified test current (I_T)
- V_C Clamping Voltage** -- Peak voltage measured across the TVS at a specified I_{ppm} (peak impulse current)
- I_R Reverse Leakage Current** -- Current measured at V_R
- V_F Forward Voltage Drop for Uni-directional**

Ratings and Characteristic Curves ($T_A=25^\circ\text{C}$ unless otherwise noted)

Figure 1: TVS Transients Clamping Waveform

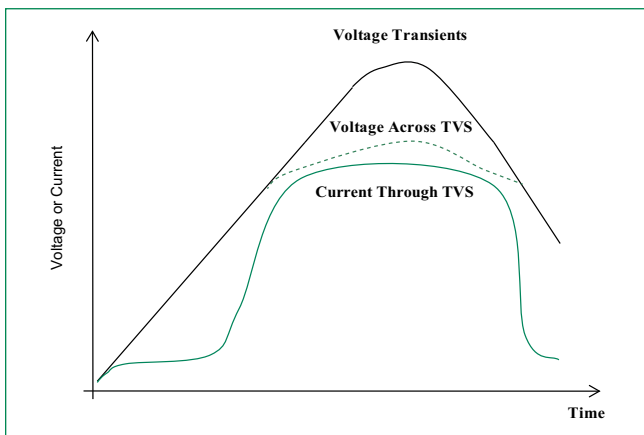
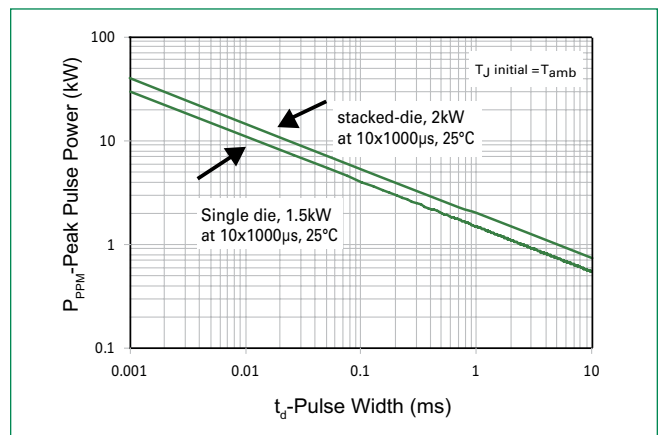

Figure 2: Peak Pulse Power Rating



1.5SMC Series

Surface Mount – 1500W

Ratings and Characteristic Curves ($T_A=25^\circ\text{C}$ unless otherwise noted) (Continued)

Figure 3: Peak Pulse Power Derating Curve

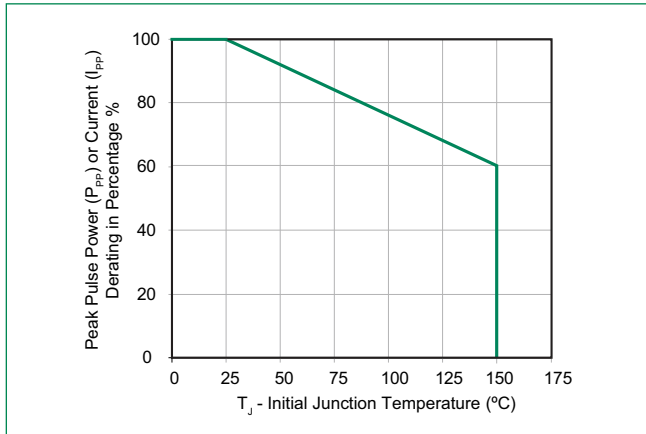

Figure 4: Pulse Waveform

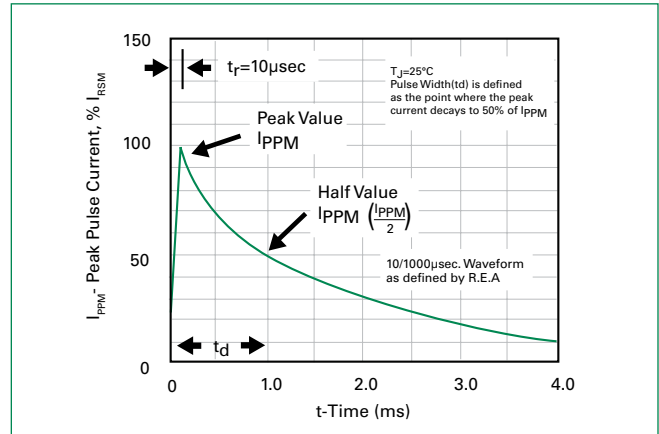

Figure 5: Typical Junction Capacitance

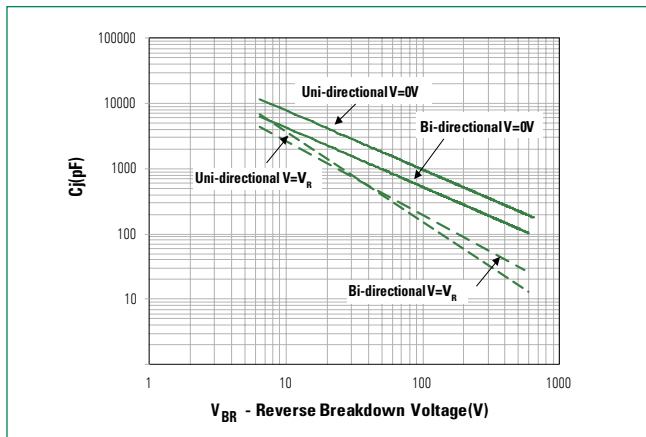

Figure 6: Typical Transient Thermal Impedance

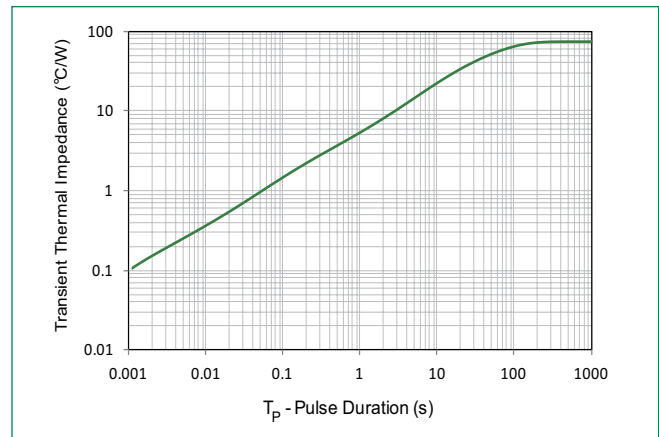

Figure 7: Maximum Non-Repetitive Peak Forward Surge Current Uni-Directional Only

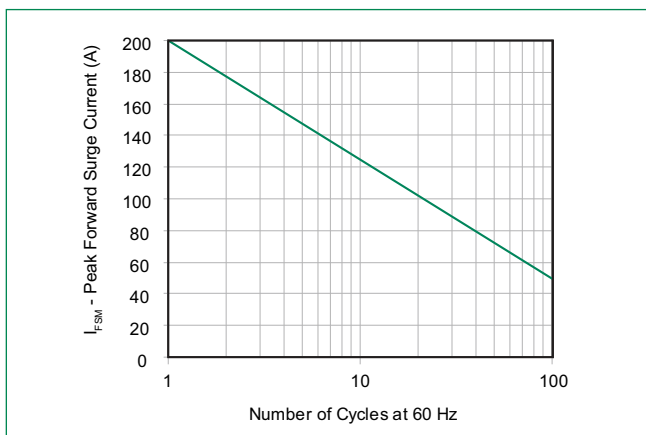
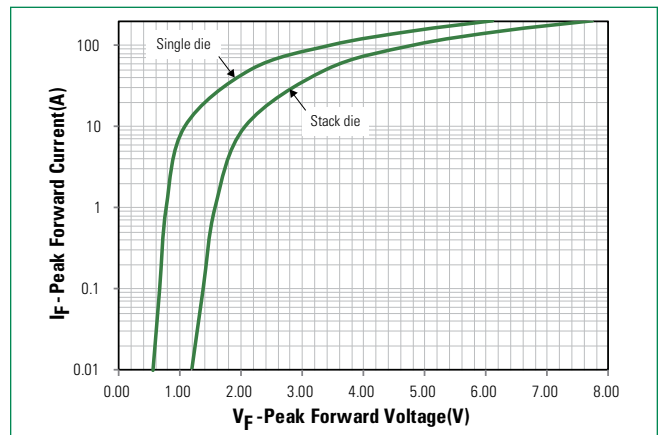

Figure 8: Peak Forward Voltage Drop vs Peak Forward Current (Typical Values)



1.5SMC Series

Surface Mount – 1500W

Soldering Parameters

Reflow Condition		Lead-free assembly
Pre Heat	- Temperature Min ($T_{s(\min)}$)	150°C
	- Temperature Max ($T_{s(\max)}$)	200°C
	- Time (min to max) (t_s)	60 – 120 secs
Average ramp up rate (Liquidus Temp (T_L) to peak)		3°C/second max
$T_{s(\max)}$ to T_L - Ramp-up Rate		3°C/second max
Reflow	- Temperature (T_L) (Liquidus)	217°C
	- Time (min to max) (t_L)	60 – 150 seconds
Peak Temperature (T_p)		260 ^{+0/-5} °C
Time within 5°C of actual peak Temperature (t_p)		30 seconds max
Ramp-down Rate		6°C/second max
Time 25°C to peak Temperature (T_p)		8 minutes Max.
Do not exceed		260°C

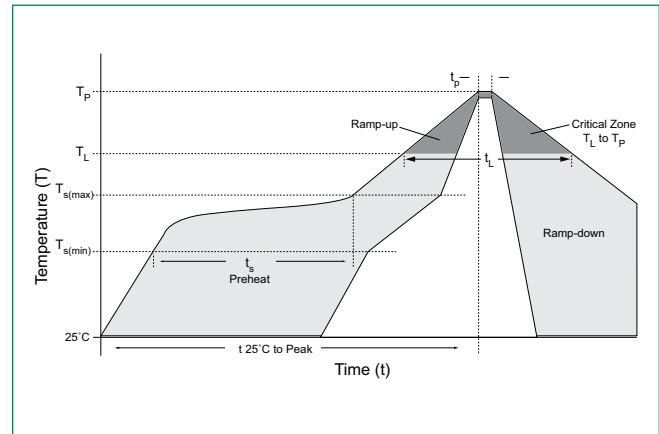

Physical Specifications

Weight	0.007 ounce, 0.21 grams
Case	JEDEC DO214AB. Molded plastic body over glass passivated junction
Polarity	Color band denotes positive end (cathode) except Bidirectional.
Terminal	Matte Tin-plated leads, Solderable per JESD22-B102

Environmental Specifications

High Temp. Storage	JESD22-A103
HTRB	JESD22-A108
Temperature Cycling	JESD22-A104
MSL	JEDEC-J-STD-020, Level 1
H3TRB	JESD22-A101
RSH	JESD22-A111

Dimensions

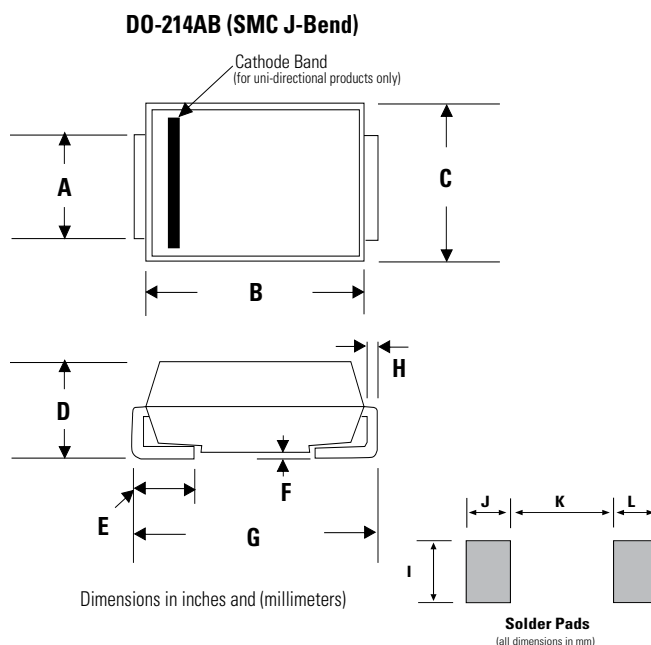

Dimensions	Inches		Millimeters	
	Min	Max	Min	Max
A	0.114	0.126	2.900	3.200
B	0.260	0.280	6.600	7.110
C	0.220	0.245	5.590	6.220
D	0.079	0.103	2.060	2.620
E	0.030	0.060	0.760	1.520
F	-	0.008	-	0.203
G	0.305	0.320	7.750	8.130
H	0.006	0.012	0.152	0.305
I	0.129	-	3.300	-
J	0.094	-	2.400	-
K	-	0.165	-	4.200
L	0.094	-	2.400	-

1.5SMC Series

Surface Mount – 1500W

Part Numbering System

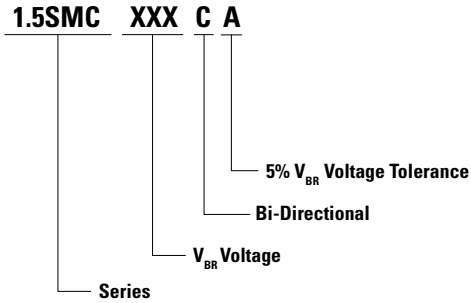

Part Marking System



Packaging

Part number	Component Package	Quantity	Packaging Option	Packaging Specification
1.5SMCxxxXX	DO-214AB	3000	Tape & Reel - 16mm tape/13" reel	EIA STD RS-481

Tape and Reel Specification

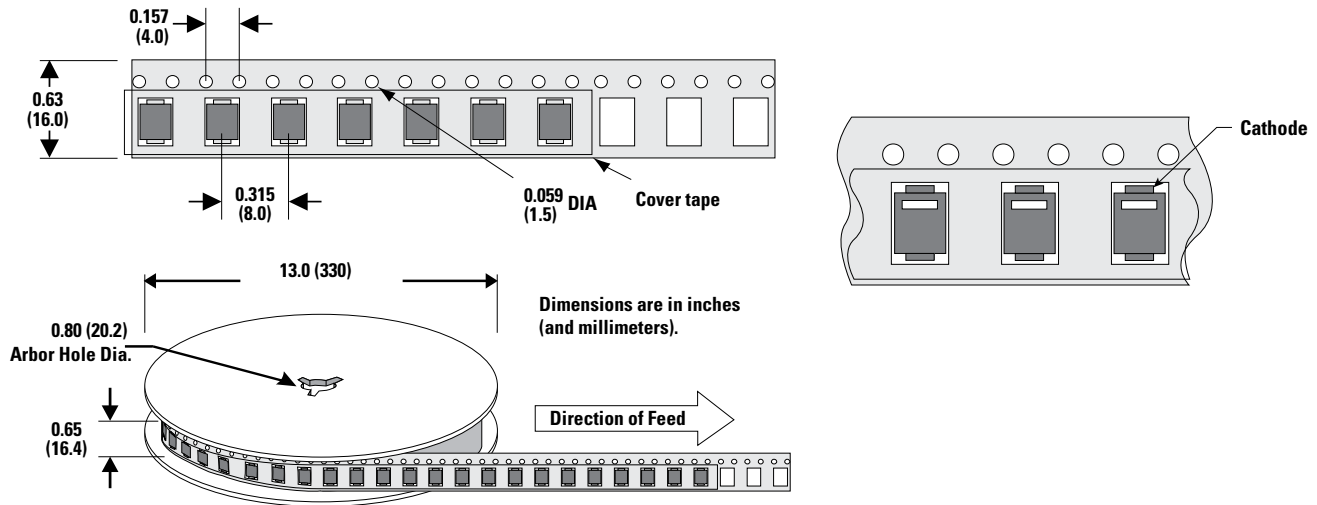

Disclaimer Notice - Littelfuse products are not designed for, and shall not be used for, any purpose (including, without limitation, automotive, military, aerospace, medical, life-saving, life-sustaining or nuclear facility applications, devices intended for surgical implant into the body, or any other application in which the failure or lack of desired operation of the product may result in personal injury, death, or property damage) other than those expressly set forth in applicable Littelfuse product documentation. Warranties granted by Littelfuse shall be deemed void for products used for any purpose not expressly set forth in applicable Littelfuse documentation. Littelfuse shall not be liable for any claims or damages arising out of products used in applications not expressly intended by Littelfuse as set forth in applicable Littelfuse documentation. The sale and use of Littelfuse products is subject to Littelfuse Terms and Conditions of Sale, unless otherwise agreed by Littelfuse. "Littelfuse" includes Littelfuse, Inc., and all of its affiliate entities. <http://www.littelfuse.com/disclaimer-electronics>.