

SP03-3.3 Series 3.3V 150A Diode Array

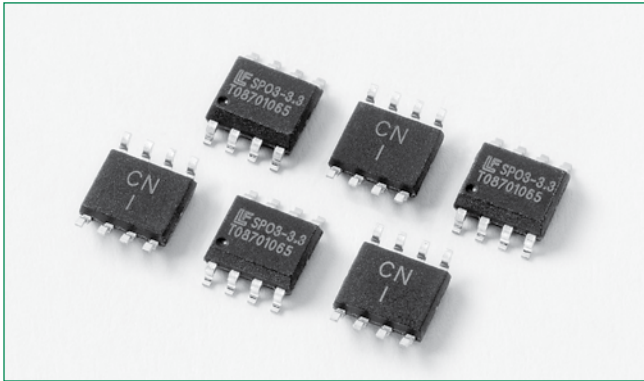

Description

This new broadband protection component from Littelfuse provides overvoltage protection for applications such as 10/100/1000 BaseT Ethernet, T3/E3 DS3 interfaces, ADSL2+, and VDSL2+. This new protector combines the TVS diode element with a diode rectifier bridge to provide both longitudinal and differential protection in one package. This design innovation results in a capacitive loading characteristic that is log-linear with respect to the signal voltage across the device. This reduces intermodulation (IM) distortion caused by a typical solid-state protection solution. The application schematic provides the connection information.

Agency Approvals

Agency	Agency File Number
	E128662

Pinout

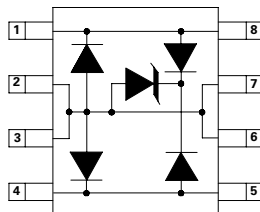

SOIC-8 (Top View)

Features

- RoHS compliant
- SOIC-8 surface mount package (JEDEC MS-012)
- Low insertion loss, log-linear capacitance
- Combined longitudinal and metallic protection
- IEC 61000-4-5, 2nd edition: 8/20 surge, 150A surge immunity
- Clamping speed of nanoseconds
- UL 94V-0 epoxy molding
- UL Recognized epoxy meeting flammability rating V-0
- Low clamping voltage
- Lead-free

Applications

- T1/E1 Line cards
- T3/E3 and DS3 Interfaces
- STS-1 Interfaces
- 10/100/1000 BaseT Ethernet

Functional Block Diagram

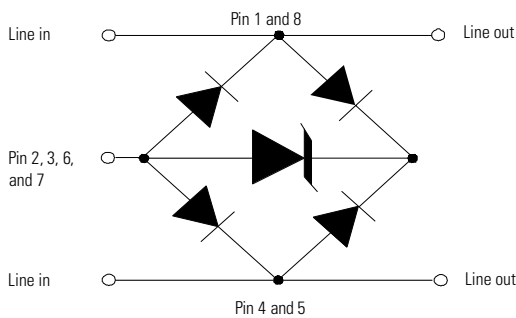

Application Example

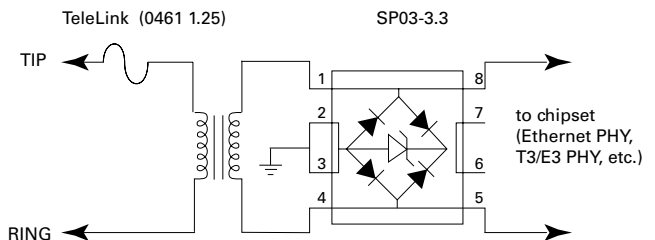

Additional Information



Datasheet



Resources



Samples

Life Support Note:

Not Intended for Use in Life Support or Life Saving Applications

The products shown herein are not designed for use in life sustaining or life saving applications unless otherwise expressly indicated.

This schematic shows a high-speed data interface protection solution. The SP03-3.3 provides both metallic (differential) and longitudinal (common mode) protection from lightning induced surge events. Its surge rating is compatible with the intra-building surge requirements of Telcordia's GR-1089-CORE, and the Basic Level Recommendations of ITU K.20 and .21. This component protects against both positive and negative induced surge events. The TeleLink fuse provides overcurrent protection for the long term 50/60 Hz power fault events.

Absolute Maximum Ratings

Parameter	Rating	Units
Peak Pulse Current (8/20µs)	150	A
Peak Pulse Power (8/20µs)	3300	W
IEC 61000-4-2, Contact Discharge, (Level 4)	30	kV
IEC 61000-4-2, Air Discharge, (Level 4)	30	kV
IEC 61000-4-5, 2nd edition (8/20µs)	150	A
Telcordia GR 1089 (Intra-Building) (2/10µs)	100	A
ITU K.20 (5/310µs)	40	A

Thermal Information

Parameter	Rating	Units
SOIC Package	170	°C/W
Operating Temperature Range	-40 to 125	°C
Storage Temperature Range	-55 to 150	°C
Maximum Junction Temperature	150	°C
Maximum Lead Temperature (Soldering 20-40s) (SOIC - Lead Tips Only)	260	°C

CAUTION: Stresses above those listed in "Absolute Maximum Ratings" may cause permanent damage to the device. This is a stress only rating and operation of the device at these or any other conditions above those indicated in the operational sections of this specification is not implied.

Electrical Characteristics (T_{OP} = 25°C)

Parameter	Symbol	Test Conditions	Min	Typ	Max	Units
Reverse Stand-Off Voltage	V _{RWM}	-	-	-	3.3	V
Reverse Breakdown Voltage	V _{BR}	I _T = 2µA	3.3	-	-	V
Reverse Breakdown Voltage	V _{BR}	I _T = 50µA	3.3	-	-	V
Reverse Leakage Current	I _R	V _{RWM} = 3.3V, T = 25°C	-	-	1	µA
Clamping Voltage, Line-Ground	V _C	I _{PP} = 50A, t _p = 8/20 µs	-	-	11.5	V
Clamping Voltage, Line-Ground	V _C	I _{PP} = 100A, t _p = 8/20 µs	-	-	15	V
Clamping Voltage, Line-Line	V _C	I _{PP} = 50A, t _p = 8/20 µs	-	-	13.5	V
Clamping Voltage, Line-Line	V _C	I _{PP} = 100A, t _p = 8/20 µs	-	-	18	V
Junction Capacitance	C _J	Between I/O Pins and Ground V _R = 0V, f = 1MHz	-	16	25	pF
		Between I/O Pins V _R = 0V, f = 1MHz	-	8	12	pF

Figure 1: Non-repetitive Peak Pulse Current vs. Pulse Time



Figure 2: Current Derating Curve

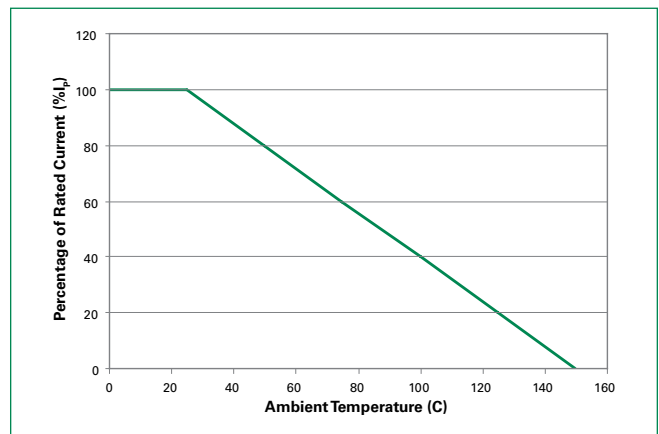

Figure 3: Pulse Waveform

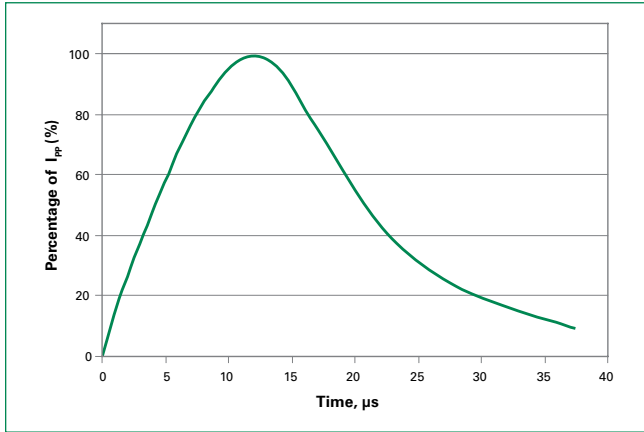

Figure 4: Clamping Voltage vs. Peak Pulse Current

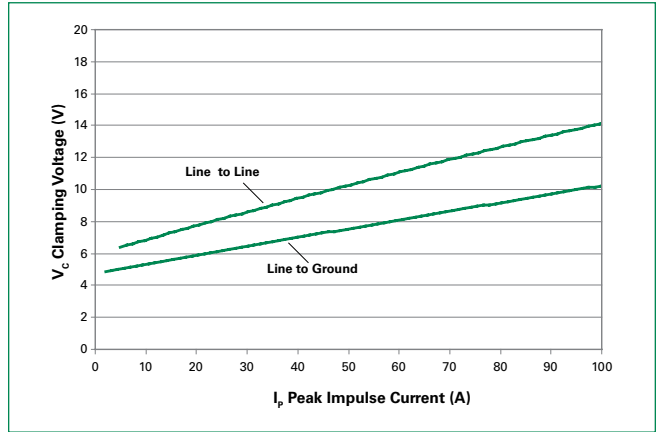

Figure 5: Capacitance vs. Reverse Voltage

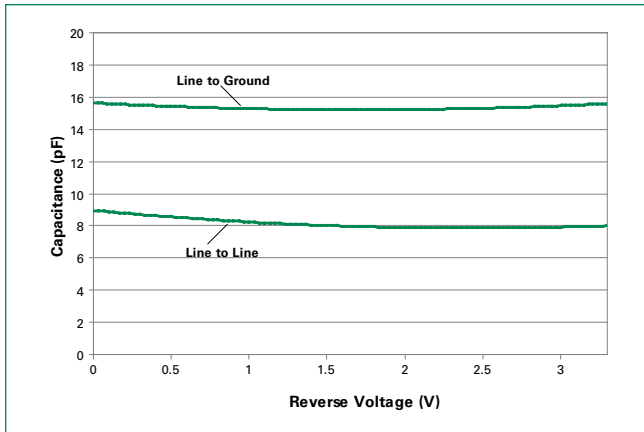
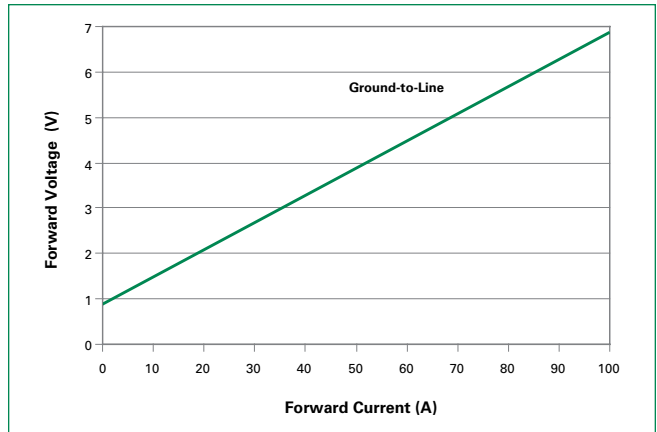
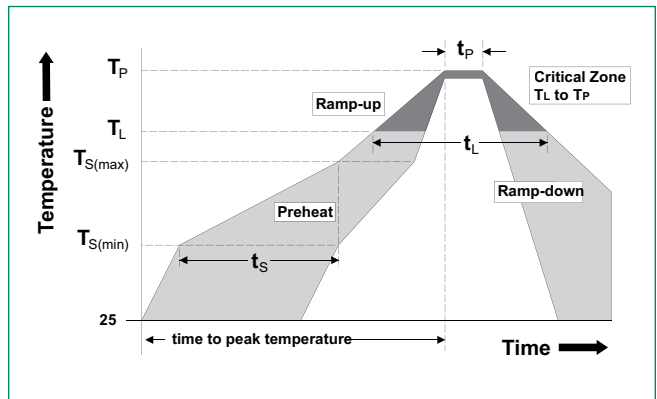

Figure 6: Forward Voltage vs. Forward Current



Soldering Parameters

Reflow Condition		Pb – Free assembly
Pre Heat	- Temperature Min ($T_{s(min)}$)	150°C
	- Temperature Max ($T_{s(max)}$)	200°C
	- Time (min to max) (t_p)	60 – 180 secs
Average ramp up rate (Liquidus) Temp (T_L) to peak		3°C/second max
$T_{s(max)}$ to T_L - Ramp-up Rate		3°C/second max
Reflow	- Temperature (T_L) (Liquidus)	217°C
	- Time (t_r)	60 – 150 seconds
Peak Temperature (T_p)		260 ^{+0.5} °C
Time within 5°C of actual peak Temperature (t_p)		20 – 40 seconds
Ramp-down Rate		6°C/second max
Time 25°C to peak Temperature (T_p)		8 minutes Max.
Do not exceed		260°C



Package Dimensions – Mechanical Drawings and Recommended Solder Pad Outline

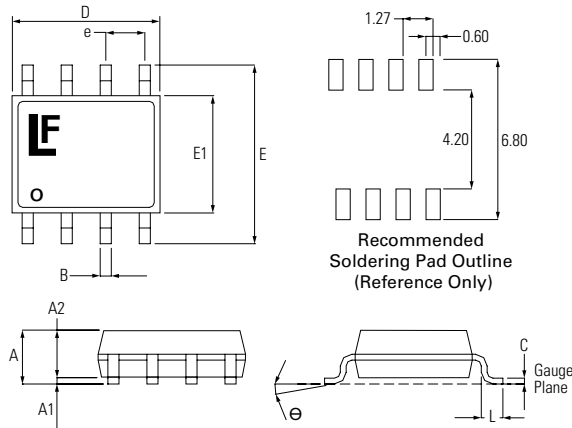

Package	SOIC-8			
Pins	8			
JEDEC	MS-012			
	Millimetres		Inches	
	Min	Max	Min	Max
A	1.35	1.75	0.053	0.069
A1	0.10	0.25	0.004	0.010
A2	1.25	1.65	0.050	0.065
B	0.31	0.51	0.012	0.020
c	0.17	0.25	0.007	0.010
D	4.80	5.00	0.189	0.197
E	5.80	6.20	0.228	0.244
E1	3.80	4.00	0.150	0.157
e	1.27 BSC		0.050 BSC	
L	0.40	1.27	0.016	0.050

Embossed Carrier Tape & Reel Specification – SOIC Package

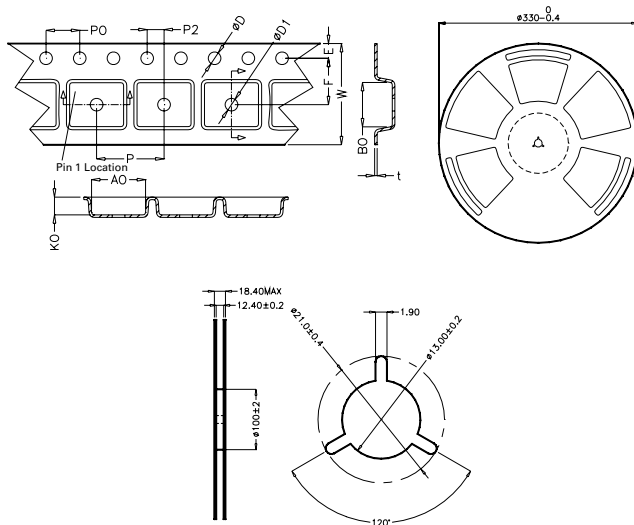

	Millimetres		Inches	
	Min	Max	Min	Max
E	1.65	1.85	0.065	0.073
F	5.4	5.6	0.213	0.22
P2	1.95	2.05	0.077	0.081
D	1.5	1.6	0.059	0.063
D1	1.50 Min		0.059 Min	
P0	3.9	4.1	0.154	0.161
10P0	40.0 ± 0.20		1.574 ± 0.008	
W	11.9	12.1	0.468	0.476
P	7.9	8.1	0.311	0.319
A0	6.3	6.5	0.248	0.256
B0	5.1	5.3	0.2	0.209
K0	2	2.2	0.079	0.087
t	0.30 ± 0.05		0.012 ± 0.002	

Part Numbering System

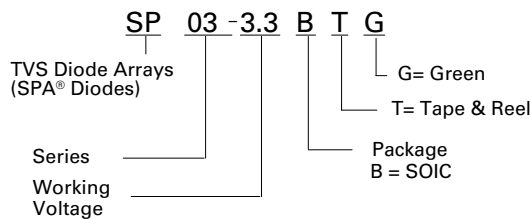

Part Marking System

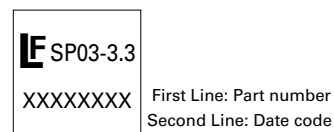

Ordering Information

Part Number	Package	Marking	Min. Order Qty.
SP03-3.3BTG	SOIC-8 Tape & Reel	SP03-3.3	2500

Disclaimer Notice - Information furnished is believed to be accurate and reliable. However, users should independently evaluate the suitability of and test each product selected for their own applications. Littelfuse products are not designed for, and may not be used in, all applications. Read complete Disclaimer Notice at <http://www.littelfuse.com/disclaimer-electronics>.