

CoolMOS™ 1) Power MOSFET

Electrically isolated back surface
 2500 V electrical isolation
 N-Channel Enhancement Mode
 Low $R_{DS(on)}$, high V_{DSS} MOSFET
 Ultra low gate charge

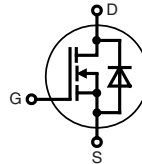
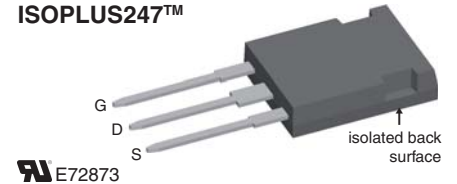

$$\begin{aligned} V_{DSS} &= 600 \text{ V} \\ I_{D25} &= 47 \text{ A} \\ R_{DS(on) \text{ max}} &= 45 \text{ m}\Omega \end{aligned}$$

ISOPLUS247™

MOSFET			
Symbol	Conditions	Maximum Ratings	
V_{DSS}	$T_{VJ} = 25^\circ\text{C}$	600	V
V_{GS}		± 20	V
I_{D25}	$T_C = 25^\circ\text{C}$	47	A
I_{D90}	$T_C = 90^\circ\text{C}$	32	A
E_{AS} E_{AR}	single pulse repetitive } $I_D = 11 \text{ A}; T_C = 25^\circ\text{C}$	1950 3	mJ mJ
dV/dt	MOSFET dV/dt ruggedness $V_{DS} = 0 \dots 480 \text{ V}$	50	V/ns

Features

- Silicon chip on Direct-Copper-Bond substrate
 - high power dissipation
 - isolated mounting surface
 - 2500 V electrical isolation
 - low drain to tab capacitance ($< 30 \text{ pF}$)
- Fast CoolMOS™ 1) power MOSFET 4th generation
 - high blocking capability
 - lowest resistance
 - avalanche rated for unclamped inductive switching (UIS)
 - low thermal resistance due to reduced chip thickness
- Enhanced total power density

Symbol	wiConditions	Characteristic Values			
		min.	typ.	max.	
$R_{DS(on)}$	$V_{GS} = 10 \text{ V}; I_D = 44 \text{ A}$		40	45	m Ω
$V_{GS(th)}$	$V_{DS} = V_{GS}; I_D = 3 \text{ mA}$	2.5	3	3.5	V
I_{DSS}	$V_{DS} = V_{DSS}; V_{GS} = 0 \text{ V}$			10	μA
I_{GSS}	$V_{GS} = \pm 20 \text{ V}; V_{DS} = 0 \text{ V}$			100	nA
C_{iss} C_{oss}	$V_{GS} = 0 \text{ V}; V_{DS} = 100 \text{ V}$ $f = 1 \text{ MHz}$		6800 320		pF pF
Q_g Q_{gs} Q_{gd}	$V_{GS} = 0 \text{ to } 10 \text{ V}; V_{DS} = 400 \text{ V}; I_D = 44 \text{ A}$		150 35 50	190	nC nC nC
$t_{d(on)}$ t_r $t_{d(off)}$ t_f	$V_{GS} = 10 \text{ V}; V_{DS} = 400 \text{ V}$ $I_D = 44 \text{ A}; R_G = 3.3 \Omega$		30 20 100 10		ns ns ns ns
R_{thJC} R_{thCH}	with heatsink compound		0.25	0.45	K/W K/W

($T_{VJ} = 25^\circ\text{C}$, unless otherwise specified)

Applications

- Switched mode power supplies (SMPS)
- Uninterruptible power supplies (UPS)
- Power factor correction (PFC)
- Welding
- Inductive heating
- PDP and LCD adapter

Advantages

- Easy assembly: no screws or isolation foils required
- Space savings
- High power density
- High reliability

¹⁾ CoolMOS™ is a trademark of Infineon Technologies AG.

Source-Drain Diode

Symbol	Conditions	Characteristic Values		
		min.	typ.	max.
($T_{VJ} = 25^{\circ}\text{C}$, unless otherwise specified)				
I_S	$V_{GS} = 0\text{ V}$		44	A
V_{SD}	$I_F = 44\text{ A}; V_{GS} = 0\text{ V}$	0.9	1.2	V
t_{rr} Q_{RM} I_{RM}	$I_F = 44\text{ A}; -di_F/dt = 100\text{ A}/\mu\text{s}; V_R = 400\text{ V}$	600		ns
		17		μC
		60		A

Component

Symbol	Conditions	Maximum Ratings	
T_{VJ}	operating	-55...+150	$^{\circ}\text{C}$
T_{stg}	storage	-55...+150	$^{\circ}\text{C}$
V_{ISOL}	$I_{ISOL} = 1\text{ mA}, 50/60\text{ Hz}, t = 1\text{ min}$	2500	V~
F_C	mounting force with clip	20-120	N

Symbol	Conditions	Characteristic Values		
		min.	typ.	max.
C_P	coupling capacity between shorted pins and mounting tab in the case		30	pF
d_S, d_A	pin - pin	tbd		mm
d_S, d_A	pin - backside metal	tbd		mm
Weight			6	g

ISOPLUS247™ Outline

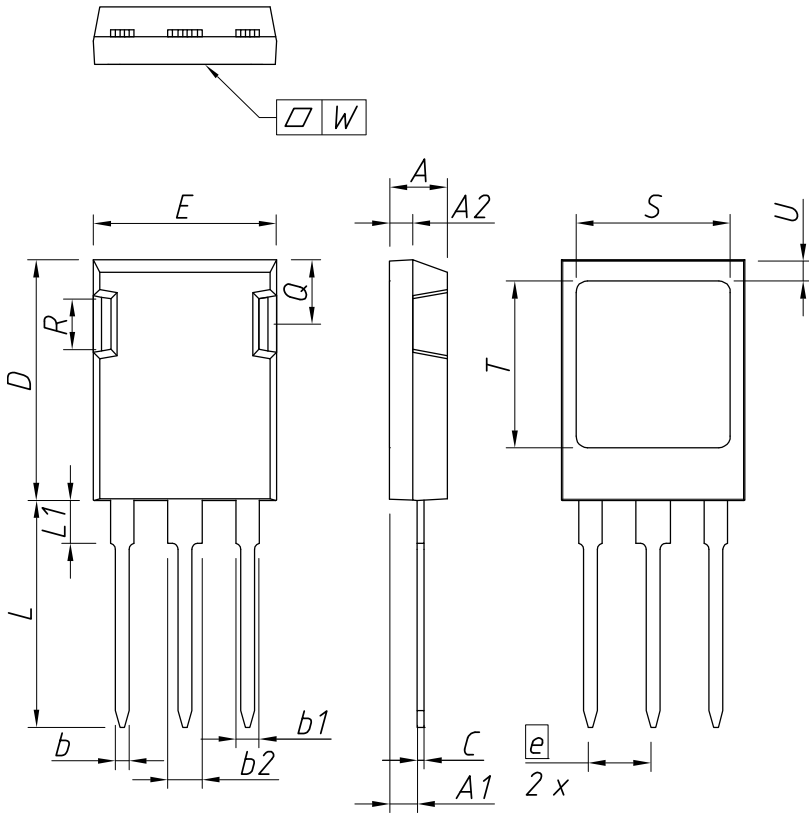

DIM.	MILLIMETER		INCHES	
	MIN	MAX	MIN	MAX
A	4,83	5,21	0,190	0,205
A1	2,29	2,54	0,090	0,100
A2	1,91	2,16	0,075	0,085
b	1,14	1,40	0,045	0,055
b1	1,91	2,15	0,075	0,085
b2	2,92	3,20	0,115	0,126
C	0,61	0,83	0,024	0,033
D	20,80	21,34	0,819	0,840
E	15,75	16,13	0,620	0,635
e	5,45 BSC		0,215 BSC	
L	19,81	20,60	0,780	0,811
L1	3,81	4,38	0,150	0,172
Q	5,59	6,20	0,220	0,244
R	4,32	4,85	0,170	0,191
S	13,21	13,72	0,520	0,540
T	15,75	16,26	0,620	0,640
U	1,65	2,03	0,065	0,080
W	-	0,10	-	0,004

Die konvexe Form des Substrates ist typ. < 0.04 mm über der Kunststoffoberfläche der Bauteilunterseite
 The convex bow of substrate is typ. < 0.04 mm over plastic surface level of device bottom side

Die Gehäuseabmessungen entsprechen dem Typ TO-247 AD gemäß JEDEC außer Schraubloch und L_{max}.
 This drawing will meet all dimensions requirement of JEDEC outline TO-247 AD except screw hole and except L_{max}.

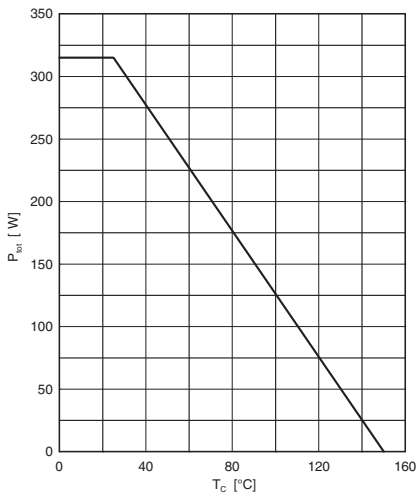

Fig. 1 Typ. power dissipation

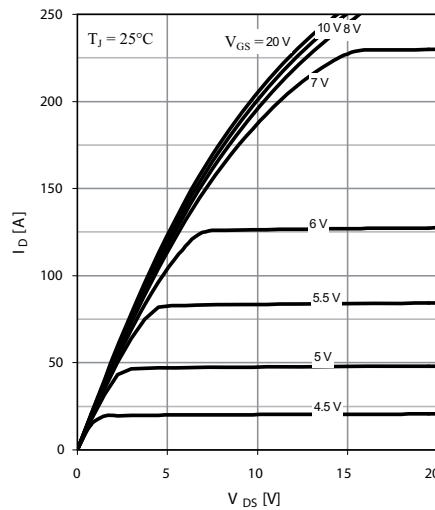

Fig. 2 Typ. output characteristics

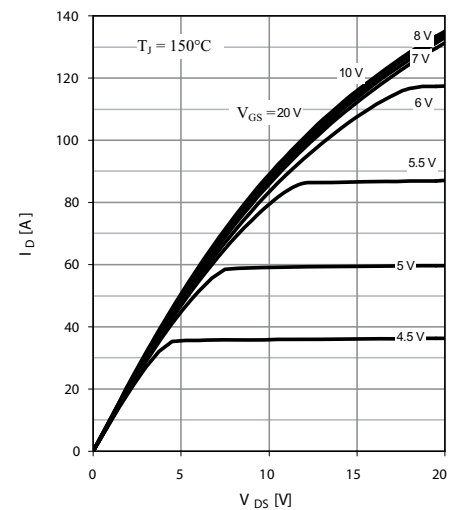

Fig. 3 Typ. output characteristics

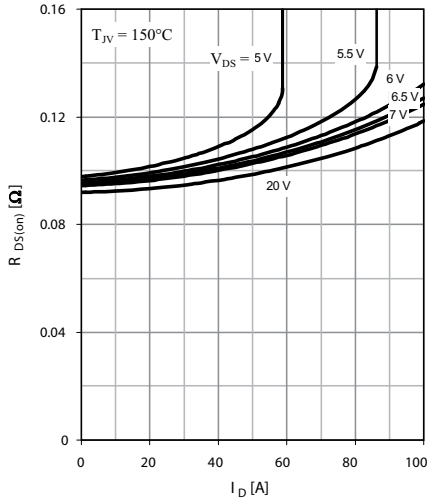

Fig. 4 Typ. drain-source on-state resistance

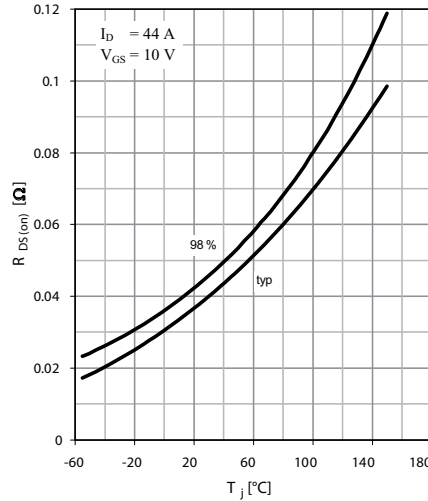

Fig. 5 Drain-source on-state resistance

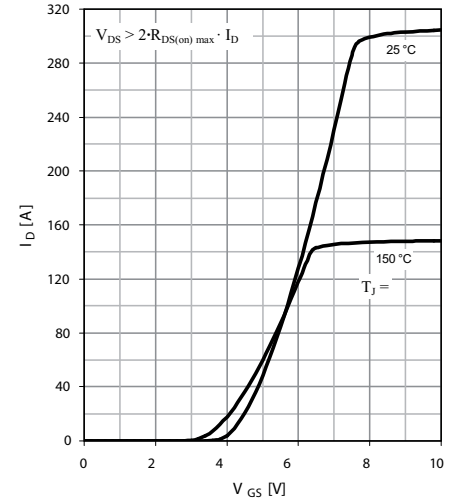

Fig. 6 Typ. transfer characteristics

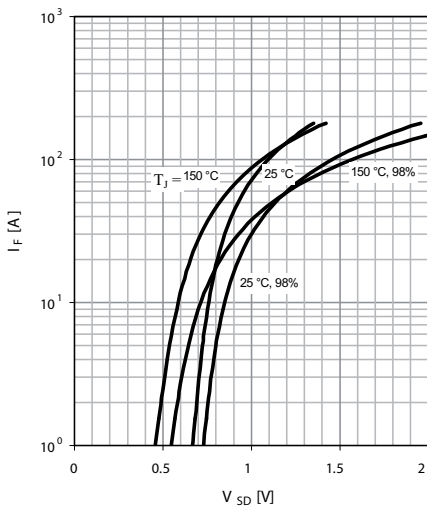

Fig. 7 Forward characteristic of reverse diode

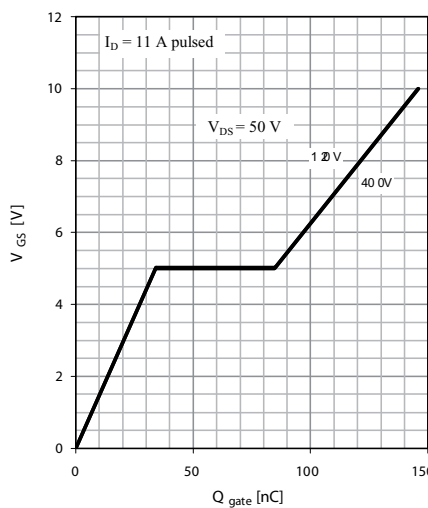

Fig. 8 Typ. gate charge

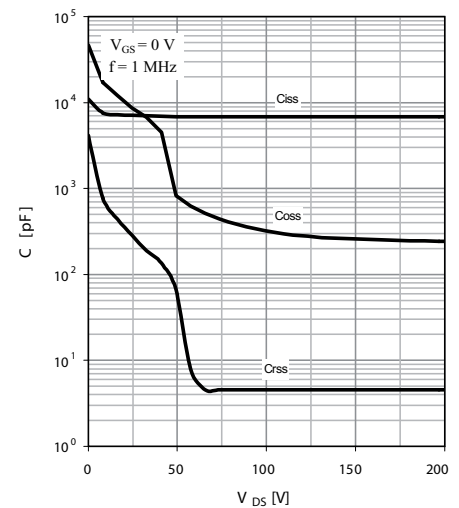

Fig. 9 Typ. capacitances

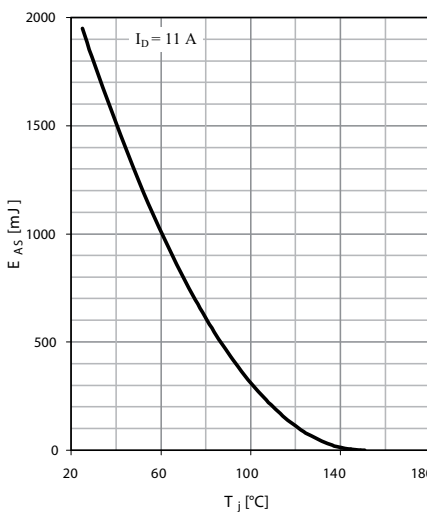

Fig. 9 Avalanche energy

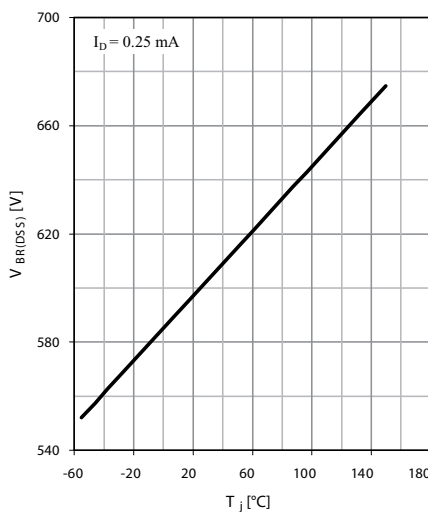

Fig. 10 Drain-source breakdown voltage

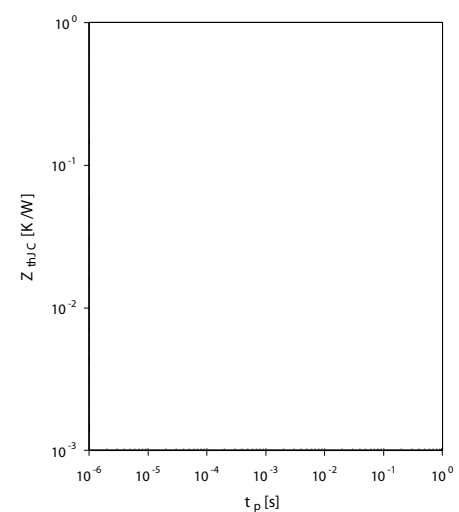

Fig. 12 Max. transient thermal impedance

IXYS reserves the right to change limits, test conditions and dimensions.

20080523b



Disclaimer Notice - Information furnished is believed to be accurate and reliable. However, users should independently evaluate the suitability of and test each product selected for their own applications. Littelfuse products are not designed for, and may not be used in, all applications. Read complete Disclaimer Notice at www.littelfuse.com/disclaimer-electronics.