

HiPerFET™ Power MOSFETs

N-Channel Enhancement Mode
High dv/dt, Low t_{rr} , HDMOS™ Family

Preliminary data sheet

IXFT 10N100
IXFT 12N100

V_{DSS}	I_{D25}	$R_{DS(on)}$
1000 V	10 A	1.20 Ω
1000 V	12 A	1.05 Ω

$t_{rr} \leq 250$ ns

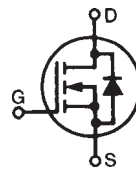

TO-268 Case Style

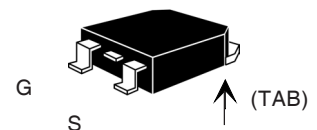

G = Gate,
S = Source,
TAB = Drain

Symbol	Test Conditions	Maximum Ratings	
V_{DSS}	$T_J = 25^\circ\text{C}$ to 150°C	1000	V
V_{DGR}	$T_J = 25^\circ\text{C}$ to 150°C ; $R_{GS} = 1$ M Ω	1000	V
V_{GS}	Continuous	± 20	V
V_{GSM}	Transient	± 30	V
I_{D25}	$T_C = 25^\circ\text{C}$	10N100: 10 12N100: 12	A
I_{DM}	$T_C = 25^\circ\text{C}$, pulse width limited by T_{JM}	10N100: 40 12N100: 48	A
I_{AR}	$T_C = 25^\circ\text{C}$	10N100: 10 12N100: 12	A
E_{AR}	$T_C = 25^\circ\text{C}$	30	mJ
dv/dt	$I_S \leq I_{DM}$, $di/dt \leq 100$ A/ μs , $V_{DD} \leq V_{DSS}$, $T_J \leq 150^\circ\text{C}$, $R_G = 2$ Ω	5	V/ns
P_D	$T_C = 25^\circ\text{C}$	300	W
T_J		-55 ... +150	$^\circ\text{C}$
T_{JM}		150	$^\circ\text{C}$
T_{stg}		-55 ... +150	$^\circ\text{C}$
T_L	1.6 mm (0.062 in.) from case for 10 s	300	$^\circ\text{C}$
M_d	Mounting torque	1.13/10	Nm/lb.in.
Weight		TO-268 = 6 g	

Features

- International standard package
- Low $R_{DS(on)}$ HDMOS™ process
- Rugged polysilicon gate cell structure
- Unclamped Inductive Switching (UIS) rated
- Low package inductance - easy to drive and to protect
- Fast intrinsic Rectifier

Applications

- DC-DC converters
- Synchronous rectification
- Battery chargers
- Switched-mode and resonant-mode power supplies
- DC choppers
- AC motor control
- Temperature and lighting controls
- Low voltage relays

Advantages

- Surface mountable, high power package
- Space savings
- High power density

Symbol	Test Conditions	Characteristic Values ($T_J = 25^\circ\text{C}$, unless otherwise specified)		
		min.	typ.	max.
V_{DSS}	$V_{GS} = 0$ V, $I_D = 3$ mA	1000		V
$V_{GS(th)}$	$V_{DS} = V_{GS}$, $I_D = 4$ mA	2.0		4.5 V
I_{GSS}	$V_{GS} = \pm 20$ V _{DC} , $V_{DS} = 0$			± 100 nA
I_{DSS}	$V_{DS} = 0.8 \cdot V_{DSS}$, $T_J = 25^\circ\text{C}$ $V_{GS} = 0$ V, $T_J = 125^\circ\text{C}$			250 μA 1 mA
$R_{DS(on)}$	$V_{GS} = 10$ V, $I_D = 0.5 \cdot I_{D25}$ Pulse test, $t \leq 300$ μs , duty cycle $d \leq 2$ %	10N100 12N100		1.20 Ω 1.05 Ω

Symbol	Test Conditions	Characteristic Values		
		(T _J = 25°C, unless otherwise specified)		
		min.	typ.	max.
g_{fs}	V _{DS} = 10 V; I _D = 0.5 • I _{D25} , pulse test	6	10	S
C_{iss}	V _{GS} = 0 V, V _{DS} = 25 V, f = 1 MHz		4000	pF
C_{oss}			310	pF
C_{rss}			70	pF
t_{d(on)}	V _{GS} = 10 V, V _{DS} = 0.5 • V _{DSS} , I _D = 0.5 • I _{D25} R _G = 2 Ω (External),		21	50 ns
t_r			33	50 ns
t_{d(off)}			62	100 ns
t_f			32	50 ns
Q_{g(on)}	V _{GS} = 10 V, V _{DS} = 0.5 • V _{DSS} , I _D = 0.5 • I _{D25}		122	155 nC
Q_{gs}			30	45 nC
Q_{gd}			50	80 nC
R_{thJC}			0.42	KW

Source-Drain Diode		Characteristic Values		
		(T _J = 25°C, unless otherwise specified)		
Symbol	Test Conditions	min.	typ.	max.
I_S	V _{GS} = 0 V	10N100 12N100		10 A 12 A
I_{SM}	Repetitive; pulse width limited by T _{JM}	10N100 12N100		40 A 48 A
V_{SD}	I _F = I _S , V _{GS} = 0 V, Pulse test, t ≤ 300 μs, duty cycle d ≤ 2 %			1.5 V
t_{rr}	I _F = I _S -di/dt = 100 A/μs, V _R = 100 V	T _J = 25°C		250 ns
		T _J = 125°C		400 ns
Q_{RM}		T _J = 25°C	1	μC
		T _J = 125°C	2	μC
I_{RM}		T _J = 25°C	10	A
		T _J = 125°C	15	A

TO-268 Outline

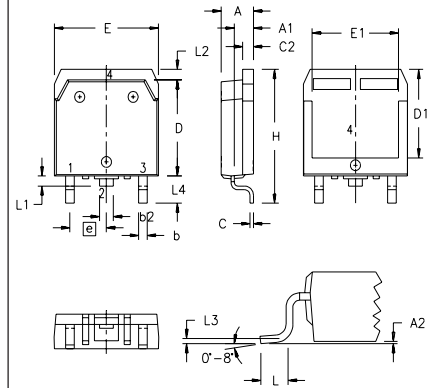

SYM	INCHES		MILLIMETERS	
	MIN	MAX	MIN	MAX
A	.193	.201	4.90	5.10
A1	.106	.114	2.70	2.90
A2	.001	.010	0.02	0.25
b	.045	.057	1.15	1.45
b2	.075	.083	1.90	2.10
C	.016	.026	0.40	0.65
C2	.057	.063	1.45	1.60
D	.543	.551	13.80	14.00
D1	.488	.500	12.40	12.70
E	.624	.632	15.85	16.05
E1	.524	.535	13.30	13.60
e	.215 BSC		5.45 BSC	
H	.736	.752	18.70	19.10
L	.094	.106	2.40	2.70
L1	.047	.055	1.20	1.40
L2	.039	.045	1.00	1.15
L3	.010 BSC		0.25 BSC	
L4	.150	.161	3.80	4.10

Min Recommended Footprint

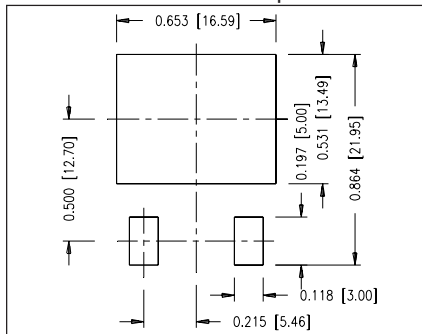

IXYS reserves the right to change limits, test conditions, and dimensions.

Fig. 1. Output Characteristics

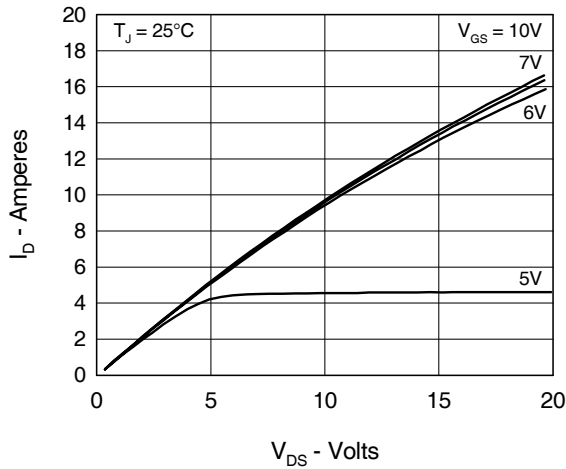

Fig. 2. Input Admittance

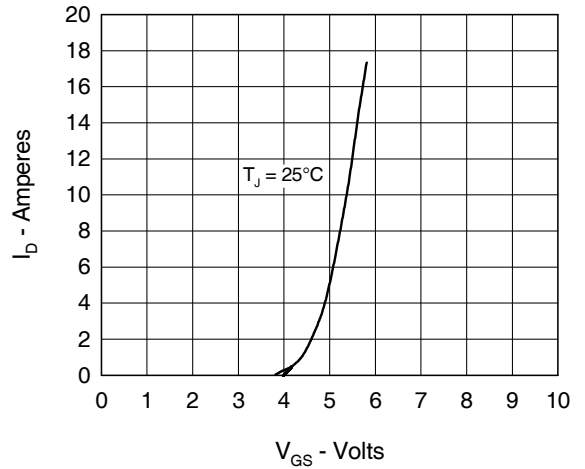

Fig. 3. $R_{DS(on)}$ vs. Drain Current

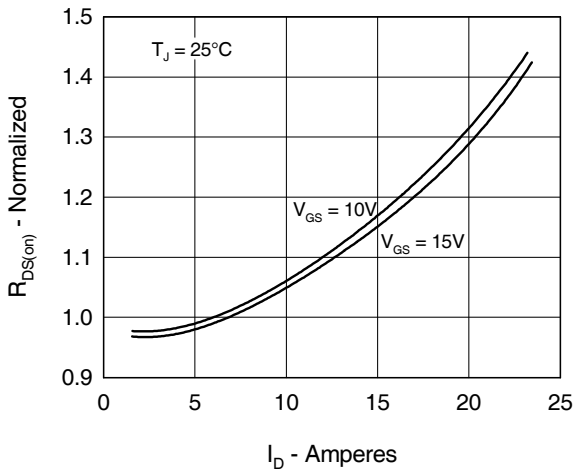

Fig. 4. Temperature Dependence of Drain to Source Resistance

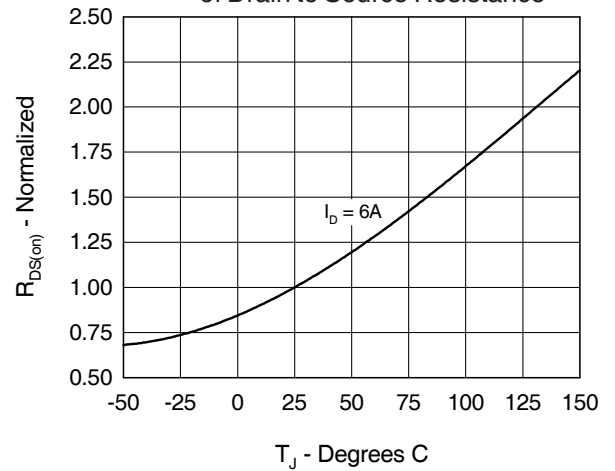

Fig. 5. Drain vs. Case Temperature

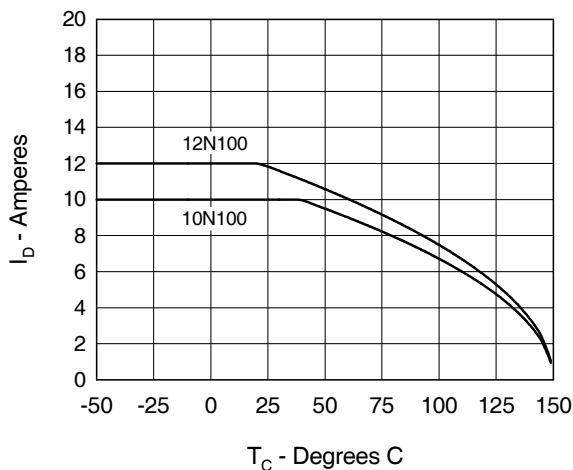

Fig. 6. Temperature Dependence of Breakdown and Threshold Voltage

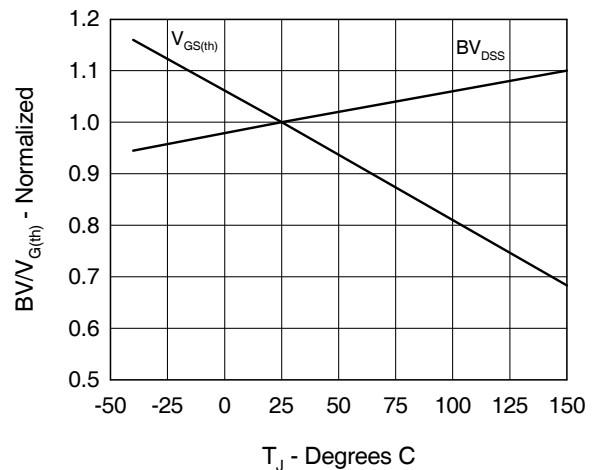

Fig. 7. Gate Charge Characteristic Curve

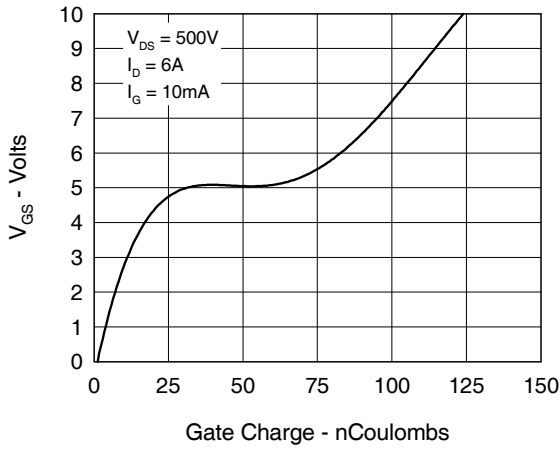

Fig. 8. Capacitance Curves

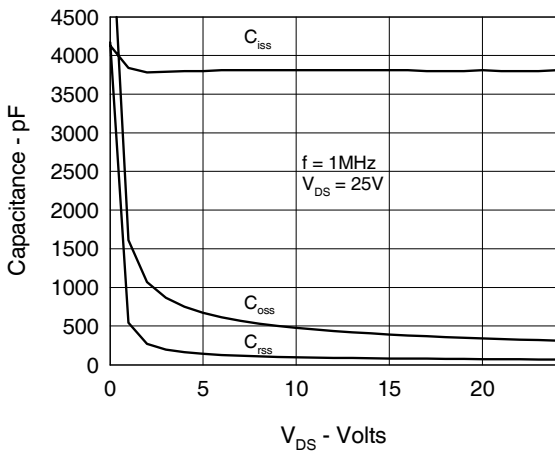

Fig. 9. Source Current vs. Source to Drain Voltage

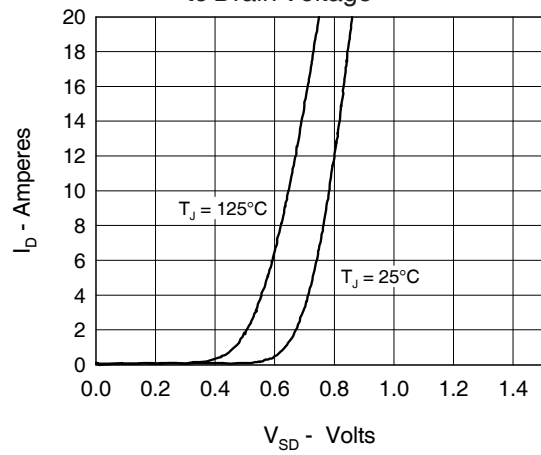
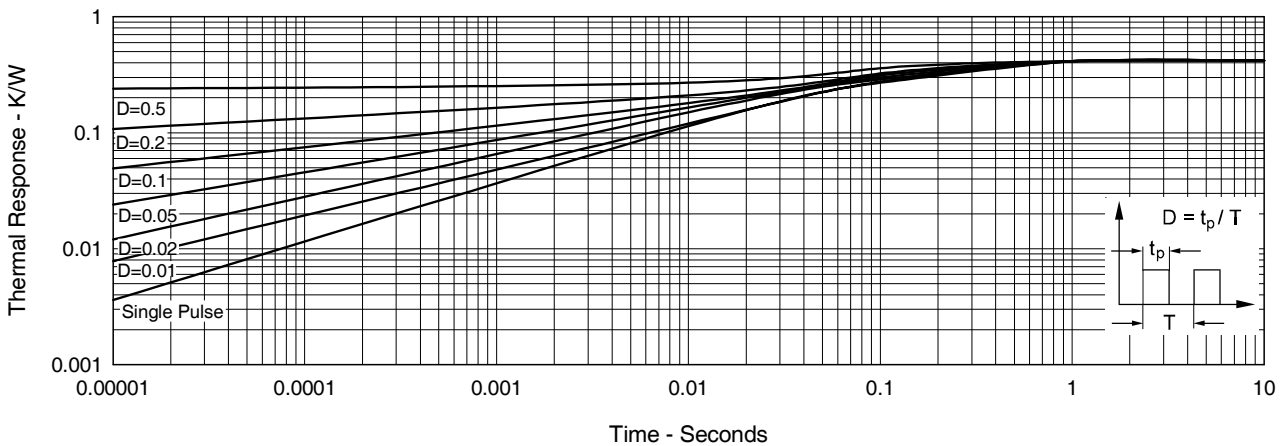

Fig.10.

Transient Thermal Impedance



IXYS reserves the right to change limits, test conditions, and dimensions.



Disclaimer Notice - Information furnished is believed to be accurate and reliable. However, users should independently evaluate the suitability of and test each product selected for their own applications. Littelfuse products are not designed for, and may not be used in, all applications. Read complete Disclaimer Notice at www.littelfuse.com/disclaimer-electronics.