

AK6-Y Series



Agency Recognitions

AGENCY	AGENCY FILE NUMBER
	E128662

Maximum Ratings and Thermal Characteristics (T_A=25°C unless otherwise noted)

Parameter	Symbol	Value	Unit
Operating Storage Temperature Range	T _{STG}	-55 to 150	°C
Operating Junction Temperature Range	T _J	-55 to 125	°C
Current Rating ¹	I _{PP}	6	kA

Note:

1. Rated I_{pp} measured with 8/20µs pulse.

Functional Diagram

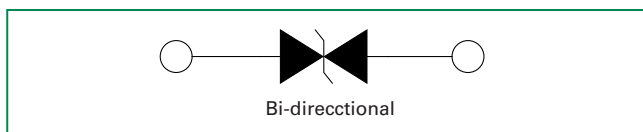

Description

The AK6-Y series of high power TVS diode is specially designed for meeting severe surge test environment of both AC and DC line protection applications. It features a very fast response and ultra low clamping characteristics as compared to MOVs (Metal Oxide Varistors). It accomplishes this by virtue of the Littelfuse Foldback™ technology, which provides a clamping voltage lower than the avalanche voltage (but above the rated working voltage); therefore, any voltage rise due to increased current conduction is maintained at a minimum magnitude, providing the best possible protection level. These AK components can be connected in series and / or parallel to create a very high surge current protection solution.

Features

- Recognized to UL 497B as an Isolated Loop Circuit Protector
- Both reflow and wave soldering capable
- Very low clamping voltage
- Ultra compact: less than one-tenth the size of traditional discrete solutions
- Sharp breakdown voltage
- Low slope resistance
- Bi-directional
- Foldback technology for superior clamping factor
- Symmetric in leads width for easier soldering during assembly.
- IEC-61000-4-2 ESD 15kV(Air), 8kV (Contact)
- ESD protection of data lines in accordance with IEC 61000-4-2
- EFT protection of data lines in accordance with IEC 61000-4-4
- Halogen-free and RoHS compliant
- Glass passivated junction
- Pb-free E4 means 2nd level interconnect is Pb-free and the terminal finish material is silver

Electrical Characteristics (T_A=25°C unless otherwise noted)

Part Numbers	Part Marking	Standoff Voltage (V _{SO}) Volts	Max. Reverse Leakage (I _R) @ V _{SO} µA	Typical I _R @ 85°C (µA)	Reverse Breakdown Voltage (V _{BR}) @ I _T		Test Current I _T (mA)	Max. Clamping Voltage V _{CL} @ I _{PP} Peak Pulse Current (I _{PP}) (Note 1)		Max. Temp Coefficient OF V _{BR} (%/°C)	Max. Capacitance 0 Bias 10kHz (nF)	Agency Approval
					Min Volts	Max Volts		V _{CL} Volts	I _{PP} Amps			
AK6-030C-Y	6-030C	30	10	15	32	37	10	90	6,000	0.1	11.0	X
AK6-058C-Y	6-058C	58	10	15	64	70	10	110	6,000	0.1	8.0	X
AK6-066C-Y	6-066C	66	10	15	72	80	10	120	6,000	0.1	6.0	X
AK6-076C-Y	6-076C	76	10	15	85	95	10	140	6,000	0.1	6.5	X
AK6-170C-Y	6-170C	170	10	15	180	220	10	260	6,000	0.1	2.8	X
AK6-190C-Y	6-190C	190	10	15	200	245	10	290	6,000	0.1	2.5	X
AK6-240C-Y	6-240C	240	10	15	250	285	10	340	6,000	0.1	2.0	X
AK6-380C-Y	6-380C	380	10	15	401	443	10	520	6,000	0.1	1.4	X
AK6-430C-Y	6-430C	430	10	15	440	490	10	625	6,000	0.1	1.0	X

Note: Using 8/20µs wave shape as defined in IEC 61000-4-5.

Figure 1 - Peak Power Derating

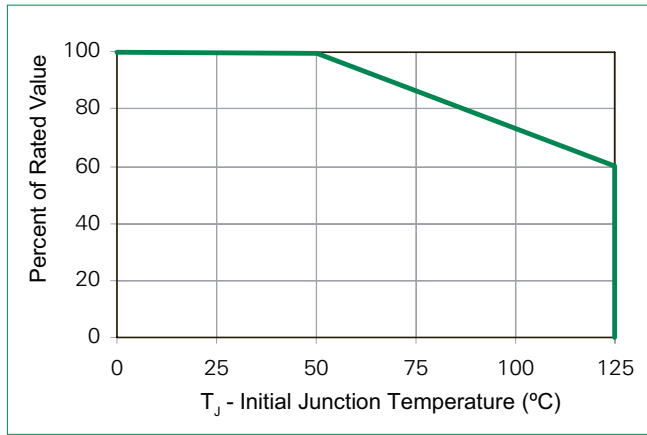

Figure 2 - Pulse Waveform

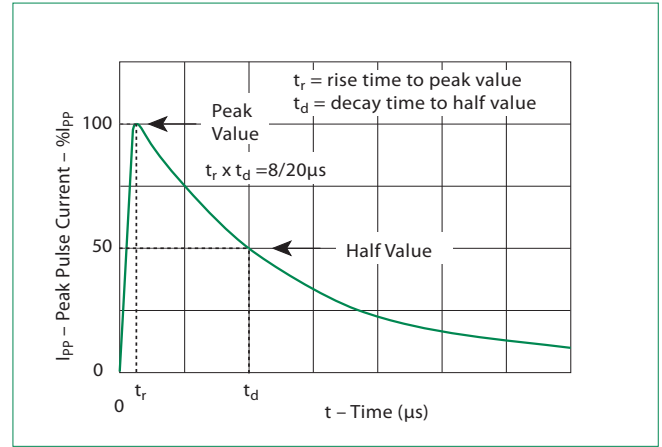

Figure 3 - Typical Peak Pulse Power Rating Curve

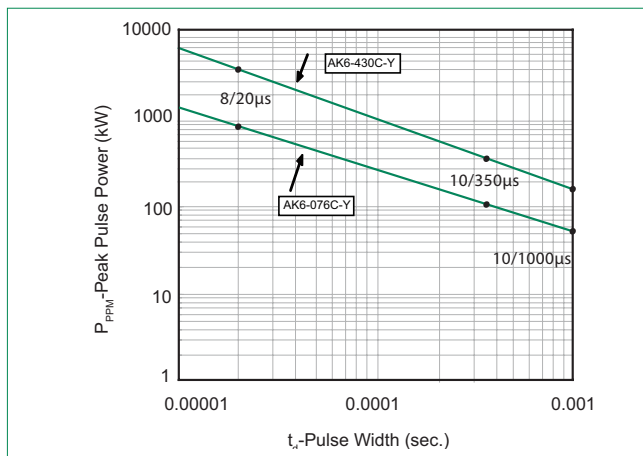

Figure 4 - Typical V_{BR} Vs Junction Temperature

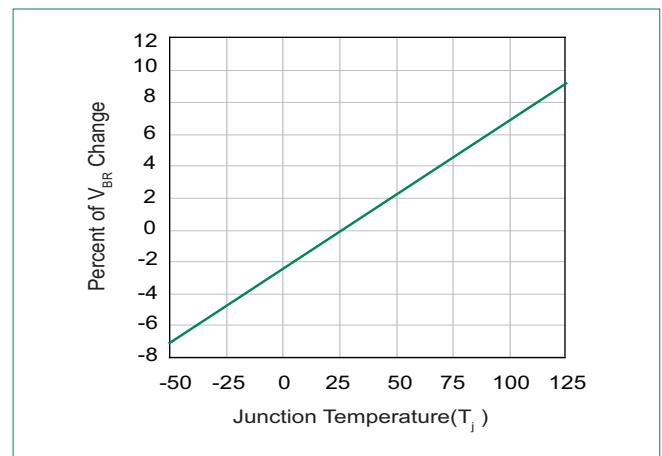
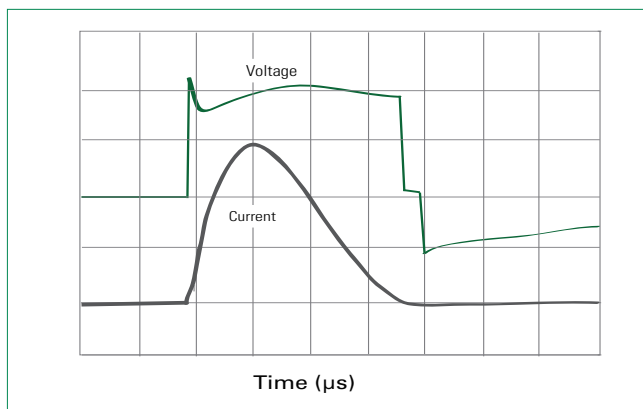

Figure 5 -Surge Response (8/20 Surge current waveform)



Note: The power dissipation causes a change in avalanche voltage during the surge and the avalanche voltage eventually returns to the original value when the transient has passed.

Soldering Parameters

Reflow Condition		Lead-free assembly
Pre Heat	- Temperature Min ($T_{s(min)}$)	150°C
	- Temperature Max ($T_{s(max)}$)	200°C
	- Time (min to max) (t_s)	60 – 120 secs
Average ramp up rate (Liquidus Temp (T_L) to peak)		3°C/second max
$T_{s(max)}$ to T_A - Ramp-up Rate		3°C/second max
Reflow	- Temperature (T_L) (Liquidus)	217°C
	- Time (min to max) (T_S)	60 – 150 seconds
Peak Temperature (T_p)		260 ^{+0/-5} °C
Time within 5°C of actual peak Temperature (t_p)		30 seconds
Ramp-down Rate		6°C/second max
Time 25°C to peak Temperature (T_p)		8 minutes Max.
Do not exceed		260°C

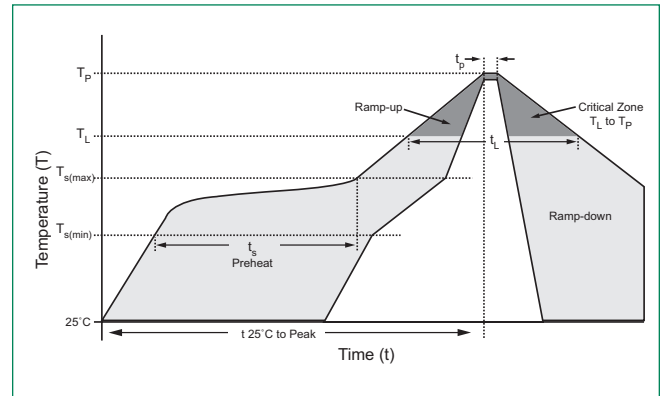

Flow Soldering (Solder Dipping)

Reflow Condition		Lead-free assembly
Pre Heat	- Temperature Min ($T_{s(min)}$)	140°C
	- Temperature Max ($T_{s(max)}$)	160°C
	- Time to Pre-Heat Temp	60 – 150 secs
Average ramp up rate to Pre-Heat Temp		5°C/second max
Peak Temperature (T_p)		260 ^{+0/-5} °C
Average ramp up rate (pre-heat to T_p)		5°C/second max
Time within actual peak Temperature Max		6 seconds
Ramp-down Rate		5°C/second max

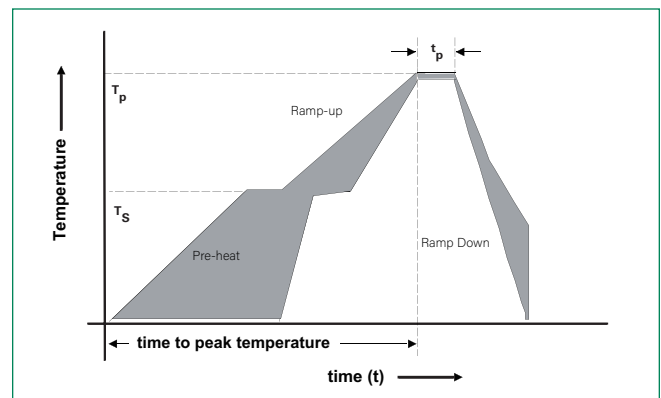

Physical Specifications

Weight	Contact manufacturer
Case	UL Recognized compound meeting flammability rating V-0
Terminal	Silver plated leads, solderable per MIL-STD-750 Method 2026

Dimensions

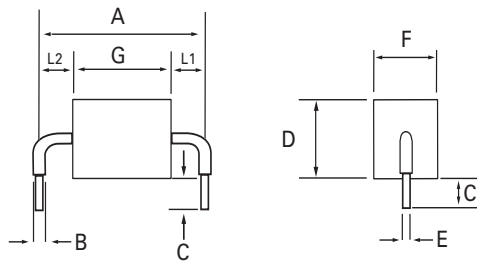

Dimensions	Inches	Millimeters
A	0.950 +/- 0.040	24.15 +/- 1.00
B	0.095 +/- 0.024	2.4 +/- 0.60
C	0.236 +/- 0.040	6.00 +/- 1.00
D	0.570 max.	14.48 max.
E	0.050 +/- 0.002	1.270 +/- 0.05
F	0.500 max.	12.70 max.
G - 030C-Y	0.161 +/- 0.040	4.10 +/- 1.00
G - 058C-Y/066C-Y 076C-Y	0.189 +/- 0.040	4.8 +/- 1.00
G - 170C-Y/190C-Y	0.320 +/- 0.040	8.13 +/- 1.00
G - 240C-Y	0.370 +/- 0.040	9.4 +/- 1.00
G - 380C-Y/430C-Y	0.543 +/- 0.040	13.8 +/- 1.00
L1/L2	L1= L2 tolerance +/- 0.04 inch (1.0 mm)	

Part Marking System

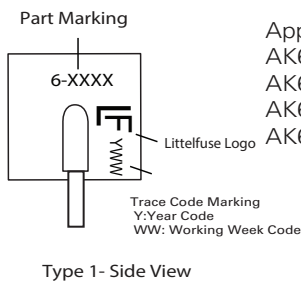

Apply to P/N listed below:
AK6-030C-Y
AK6-058C-Y
AK6-066C-Y
AK6-076C-Y

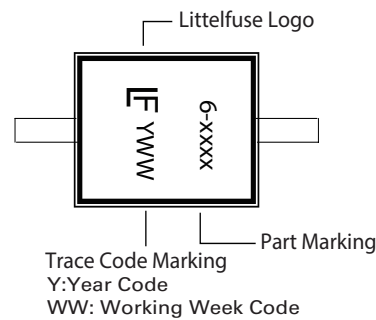

Apply to P/N listed below:
AK6-170C-Y
AK6-190C-Y
AK6-240C-Y
AK6-380C-Y
AK6-430C-Y

Part Numbering System

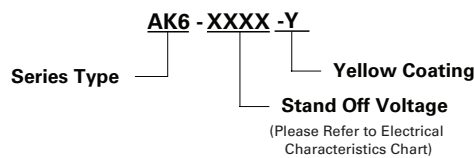

Packing Options

Part Number	Component Package	Quantity	Packaging Option
AK6-XXXX-Y	AK Package	56pcs/Box	Bulk
AK6-XXXX-Y12	AK Package	12pcs/Box	Bulk

Disclaimer Notice - Information furnished is believed to be accurate and reliable. However, users should independently evaluate the suitability of and test each product selected for their own applications. Littelfuse products are not designed for, and may not be used in, all applications. Read complete Disclaimer Notice at <http://www.littelfuse.com/disclaimer-electronics>.