

MBR6045WT

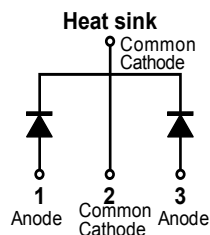

Pin out



Description

Littelfuse MBR series Schottky Barrier Rectifier is designed to meet the general requirements of commercial applications by providing high temperature, low leakage and low V_F products.

It is suitable for high frequency switching mode power supply, free-wheeling diodes and polarity protection diodes.

Features

- High junction temperature capability
- High frequency operation capability
- Guard ring for enhanced ruggedness and long term reliability
- Low forward voltage drop
- High frequency operation capability
- Common cathode configuration in TO-247AD package

Applications

- Switching mode power supply
- DC/DC converters
- Free-wheeling diodes
- Polarity protection diodes

Maximum Ratings

Parameters	Symbol	Test Conditions	Max	Unit
Peak Reverse Voltage	V_{RWM}	-	45	V
Average Forward Current	$I_{F(AV)}$	50% duty cycle @ $T_C = 135^\circ\text{C}$ rectangular wave form	30(per leg) 60(per leg)	A
Repetitive Avalanche Current(per leg)	I_{AR}	Current decaying linearly to zero in 1 μsec frequency limited by T_J max. $V_A = 1.5 \times V_R$ typical	6	A
Peak One Cycle Non-Repetitive Surge Current (per leg)	I_{FSM}	8.3 ms, half Sine pulse	432	A
Non-Repetitive Avalanche Energy(per leg)	E_{AS}	$T_J = 25^\circ\text{C}, I_{AS} = 4\text{A}, L = 3.4\text{mH}$	27	mJ

Electrical Characteristics

Parameters	Symbol	Test Conditions	Max	Unit
Forward Voltage Drop (per leg) *	V_{F1}	@ 30A, Pulse, $T_J = 25^\circ\text{C}$	0.65	V
	V_{F2}	@ 30A, Pulse, $T_J = 125^\circ\text{C}$	0.55	
Reverse Current (per leg) *	I_{R1}	@ $V_R = \text{rated } V_{DC}, T_J = 25^\circ\text{C}$	1.0	mA
	I_{R2}	@ $V_R = \text{rated } V_{DC}, T_J = 125^\circ\text{C}$	150	
Junction Capacitance (per leg)	C_T	@ $V_R = 5\text{V}, T_C = 25^\circ\text{C}, f_{SIG} = 1\text{MHz}$	1400	pF
Series Inductance (per leg)	L_S	Measured lead to lead 5 mm from package body	7.5	nH
Voltage Rate of Change	dv/dt		10,000	V/ μs

* Pulse Width < 300 μs , Duty Cycle < 2%

Thermal-Mechanical Specifications

Parameters	Symbol	Test Conditions	Max	Unit
Junction Temperature Range	T_J		-55 to +150	°C
Storage Temperature Range	T_{stg}		-55 to +150	°C
Maximum Thermal Resistance Junction to Case	R_{thJC}	DC operation	1.0 (Per device) 0.5 (Per device)	°C/W
Maximum Thermal Resistance, Case to Heat Sink	R_{thCS}	Mounting surface, smooth and greased	0.24	°C/W
Approximate Weight	wt		6.7	g
Case Style		TO-247AD		

Figure 1: Typical Forward Characteristics

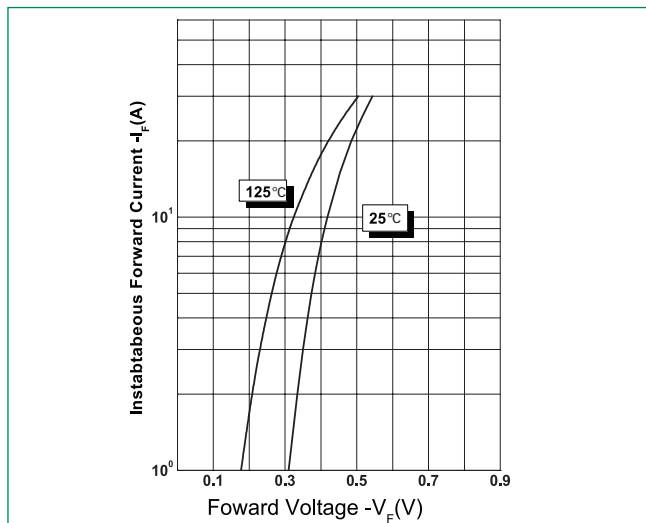

Figure 2: Typical Reverse Characteristics

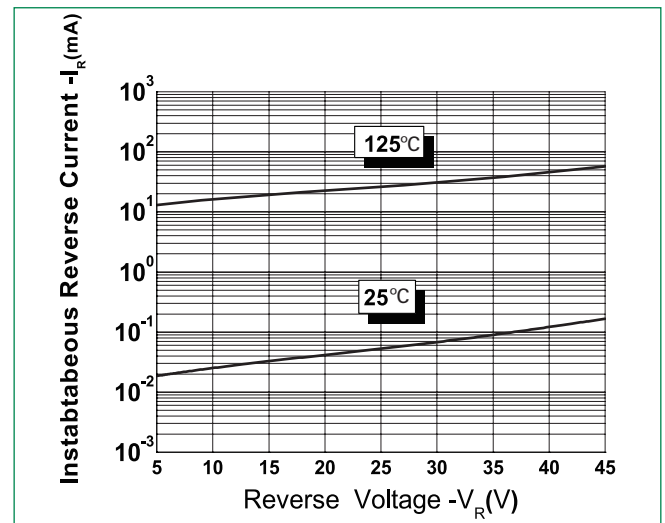
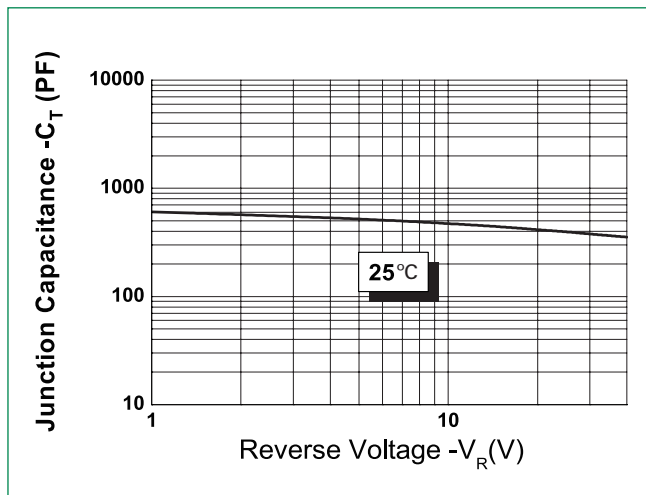
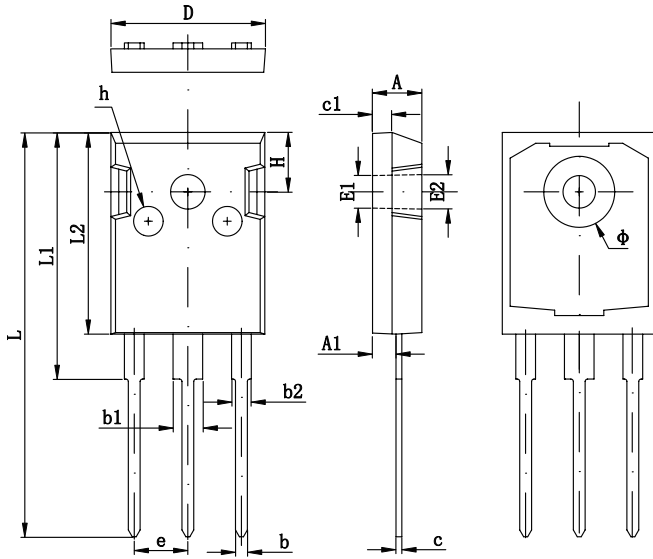

Figure 3: Typical Junction Capacitance



Dimensions- TO-247AD



Symbol	Millimeters	
	Min	Max
A	4.70	5.31
A1	2.21	2.61*
A2	1.50	2.49
b	0.99	1.40
b1	1.65	2.39
b2	2.59	3.43
c	0.38	0.89
D	20.30*	21.46
D1	13.08	-
D2	0.51	1.35
E	14.80*	16.26
E1	13.46	-
E2	4.32	5.49
E3	1.45*	2.74
e	5.461 BSC	
L	19.42*	20.85*
L1	-	4.60*
P	3.35*	3.70*
P1	-	7.40*
Q	5.38	6.20
S	5.83*	6.25*

Footnote *: The spec. does not comply with JEDEC spec.

Packing Options

Part Number	Marking	Packing Mode	M.O.O
MBR6045WT	MBR6045WT	30pcs / Tube	300

Tube Specification

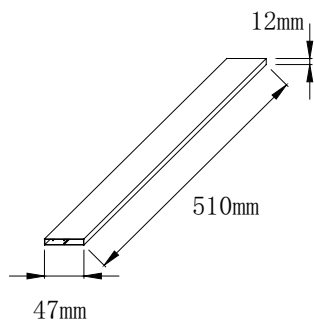

Part Numbering and Marking System

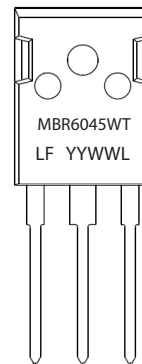

- MBR = Device Type
- 60 = Forward Current (60A)
- 45 = Reverse Voltage (45V)
- WT = Configuration
- LF = Littelfuse
- YY = Year
- WW = Week
- L = Lot Number