

MEGA® and MEGA® Clear Top Fuse

Rated 32V

RoHS



MEGA® Fuses

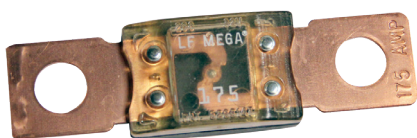

MEGA® Clear Top Housing Fuse

Description

MEGA® SLO-BLO® automotive fuses employ diffusion pill technology to provide time-delay circuit protection. MEGA fuses are ideal for use on batteries, alternators, and heavy gauge wire harnesses that experience large inrushes of current. The MEGA SLO-BLO fuses with ratings of 40 A to 250 A ensure continuous current flow. Use MEGA fuses with ratings of 300 A to 500 A only for short circuit protection.

Specifications

Voltage Rating:	32 V dc
Interrupting Rating:	2000A @ 32 V dc
Recommended Environmental Temperature:	-40 °C to +125 °C
Terminals Material:	Copper (Silver plated copper available)
Housing Material:	PPA-GF33HS (U.L. 94 Flammability rating - HB)
Clear Top Housing Material:	PES (top) (U.L. 94 Flammability rating - V0) PPA-GF33HS (bottom) (U.L. 94 Flammability rating - HB)
Mounting Torque M6:	8-14 Nm
Mounting Torque M8:	12-18 Nm
Complies with:	ISO 8820-5

Features & Benefits

- Color-coding indicates ampere rating
- Available with two mounting holes, one mounting hole, or clinch connectors
- Clear top makes it easy to see when fuse blows

Applications

- Cars
- Trucks
- SUVs
- Offroad vehicles
- Buses
- Watercraft as approved by Littelfuse®

Ordering Information

Part Number	Rating	Package Size	Plating	Bolt Size	Bolt Hole Qty
0298xxx.ZXEH	80–250	500	None	M8	2
0298xxx.ZXH	300–500	500	None	M8	2
0298xxx.UX1M8	80–500	500	None	M8	1
0298xxx.ZXB	40–250	500	Ag	M8	2
0298xxx.ZXA	80–500	500	None	M6	2

MEGA Clear Top Housing Material Fuse

0298xxx.UXT	40–250	500	None	M8	2
-------------	--------	-----	------	----	---

MEGA[®] and MEGA[®] Clear Top Fuse

Rated 32V

Ratings

Part Number	Current Rating (A)	Color Code ³	Test Cable Size (mm ²)	Typ. Voltage Drop (mV)	Typ. Cold Resistance (mΩ)	Typ. I ² t (A ² s)
0298040._ ¹	40	—	4	132	2.51	8700
0298060._ ¹	60	—	6	119	1.50	21 000
0298080._	80	Red	10	87	0.72	21 500
0298100._	100	Yellow	16	87	0.56	31 100
0298125._	125	Green	16	80	0.42	57 800
0298150._	150	Orange	25	92	0.35	100 000
0298175._	175	White	25	86	0.29	168 000
0298200._	200	Blue	35	83	0.26	204 000
0298225._	225	Brown	35	82	0.22	257 000
0298250._	250	Pink	50	82	0.20	389 000
0298300._ ²	300	Grey	70	74 ⁴	0.17	315 000
0298350._ ²	350	Dark Green	70	68 ⁴	0.14	500 000
0298400._ ²	400	Purple	70	64 ⁴	0.13	610 000
0298450._ ²	450	Gold	70	60 ⁴	0.11	1 050 000
0298500._ ²	500	Brown	70	58 ⁴	0.09	2 050 000

1: Not mentioned in ISO standards, 2: Short Circuit Protector only, 3: 0298xxx.ZXB has white font color on all ratings. 4: Voltage Drop measurements for short circuit protectors taken at 75% of rated current.

The typical I²t is an average value calculated from the breaking capacity tests by using the melting time before the arcing occurs.

Dimensions

Dimensions in mm for reference only.
See outline drawing for dimensions and tolerances.

ZX & UXT Versions

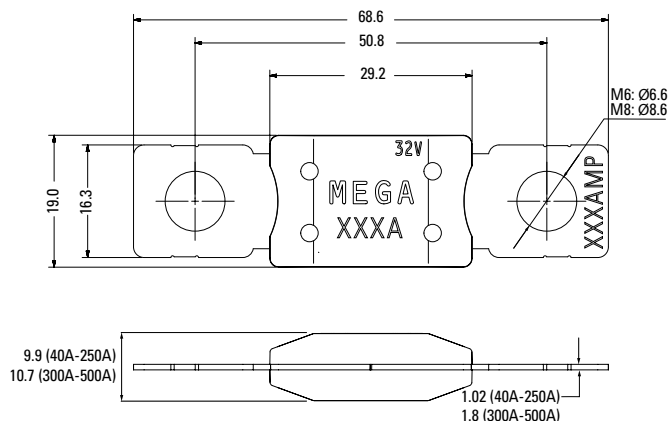

UX1M8 Version

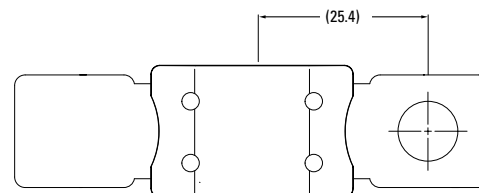

MEGA[®] and MEGA[®] Clear Top Fuse

Rated 32V

Time-Current Characteristic Curves

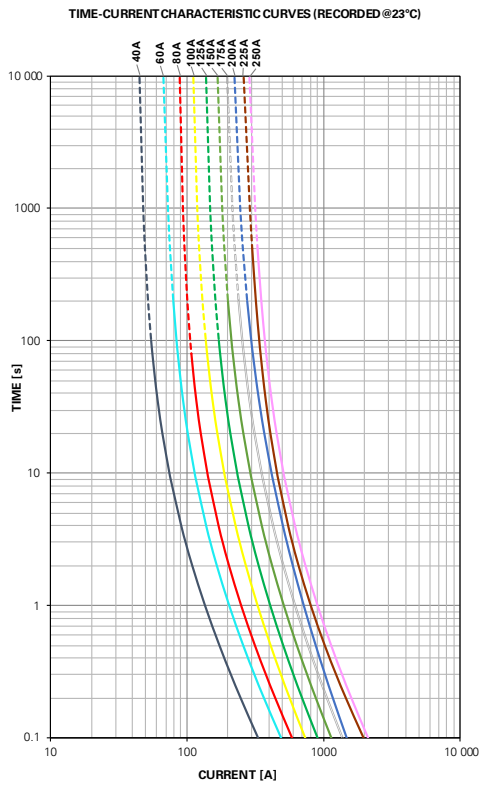

Time-Current Characteristics

% of Rating	Opening Time Min / Max (s)	
	40-250	300-500
75	- / -	14 400 / ∞
100	14 400 / ∞	- / -
135	120 / 1800	- / -
200	1 / 15	1 / 15
350	0.3 / 5	0.5 / 5
600	0.1 / 1	0.1 / 1

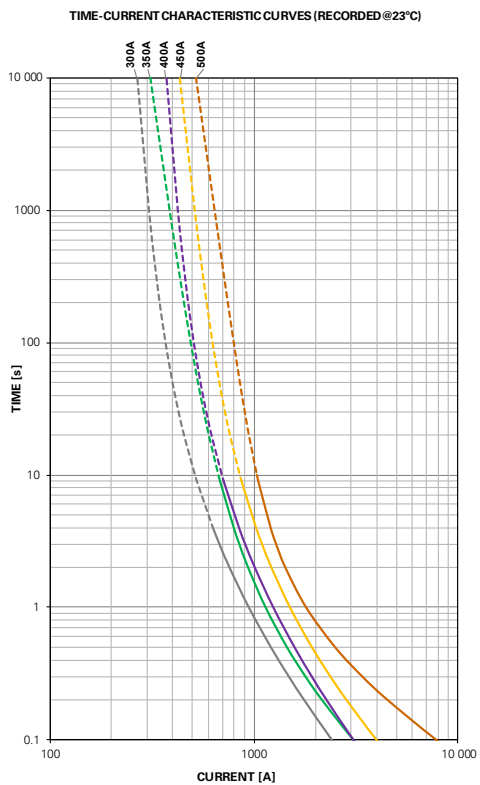

MEGA® and MEGA® Clear Top Fuse

Rated 32V

Typical Derating of Fuse Melting Element

Temperature Security Margin is 20%
Please contact Littelfuse® for Details Regarding Derating Test Set-Up.

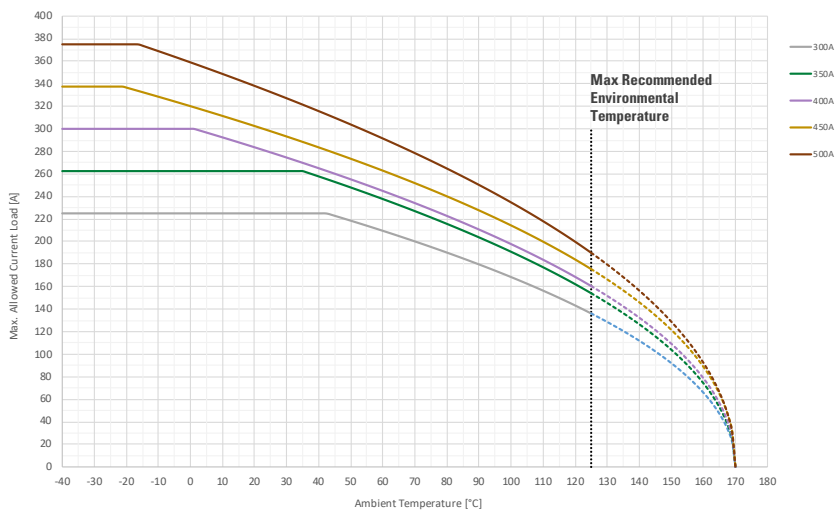
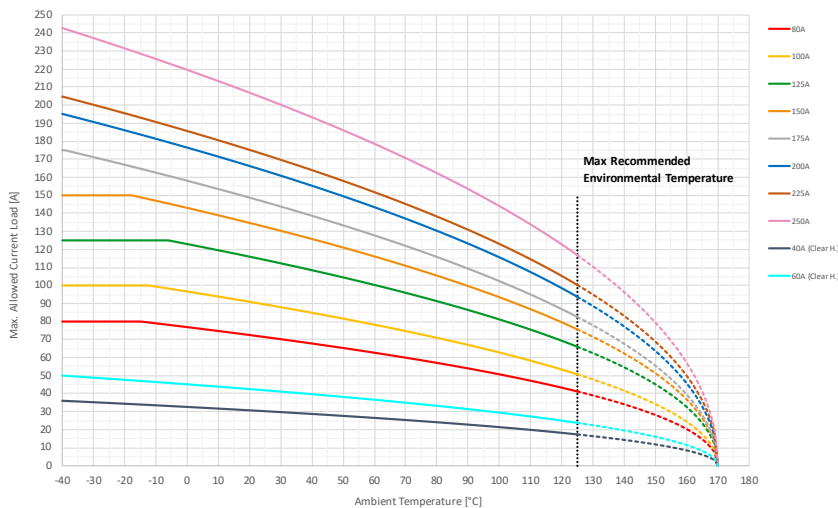

Derating curves may change depending on the final condition of the application (terminals characteristics, wire size etc.). Please ask Littelfuse for more information.

Temperature Table

Max. allowed current load (A) at ambient temperature (typical derating)							
	-40 °C	0 °C	20 °C	65 °C	85 °C	110 °C	125 °C
40A	36	33	31	26	23	20	17
60A	50	45	43	36	32	27	24
80A	80	77	73	61	56	47	41
100A	100	97	91	76	69	58	51
125A	125	123	116	98	89	76	66
150A	150	143	135	114	103	87	76
175A	175	158	149	125	113	95	83
200A	195	176	166	140	127	107	94
225A	205	186	175	148	135	115	100
250A	243	220	207	175	158	134	117
300A	225	225	225	205	185	156	136
350A	263	263	263	232	210	177	154
400A	300	300	284	240	217	184	160
450A	338	320	302	257	234	200	176
500A	375	359	338	285	258	218	190