

HiPerFET™ Power MOSFET Q2-Class

IXFB38N100Q2

N-Channel Enhancement Mode
Avalanche Rated, Low Q_g , Low Intrinsic R_G
High dV/dt , Low t_{rr}

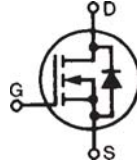

$$\begin{aligned} V_{DSS} &= 1000V \\ I_{D25} &= 38A \\ R_{DS(on)} &\leq 250m\Omega \\ t_{rr} &\leq 300ns \end{aligned}$$

| Symbol | Test Conditions | Maximum Ratings | |
|---------------|--|-----------------|------------|
| V_{DSS} | $T_J = 25^\circ C$ to $150^\circ C$ | 1000 | V |
| V_{DGR} | $T_J = 25^\circ C$ to $150^\circ C$, $R_{GS} = 1M\Omega$ | 1000 | V |
| V_{GSS} | Continuous | ± 30 | V |
| V_{GSM} | Transient | ± 40 | V |
| I_{D25} | $T_C = 25^\circ C$ | 38 | A |
| I_{DM} | $T_C = 25^\circ C$, pulse width limited by T_{JM} | 152 | A |
| I_A | $T_C = 25^\circ C$ | 38 | A |
| E_{AS} | $T_C = 25^\circ C$ | 5 | J |
| dV/dt | $I_S \leq I_{DM}$, $V_{DD} \leq V_{DSS}$, $T_J \leq 150^\circ C$ | 20 | V/ns |
| P_D | $T_C = 25^\circ C$ | 890 | W |
| T_J | | -55 ... +150 | $^\circ C$ |
| T_{JM} | | 150 | $^\circ C$ |
| T_{stg} | | -55 ... +150 | $^\circ C$ |
| T_L | 1.6 mm (0.063 in.) from case for 10s | 300 | $^\circ C$ |
| T_{sOLD} | Plastic body for 10s | 260 | $^\circ C$ |
| F_C | Mounting force | 30..120/6.7..27 | N / lbs |
| Weight | | 10 | g |

PLUS264™(IXFB)

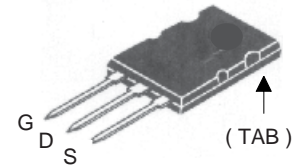

G = Gate D = Drain
S = Source TAB = Drain

Features

- Double metal process for low gate resistance
- Unclamped Inductive Switching (UIS) rated
- Low package inductance
- easy to drive and to protect
- Fast intrinsic rectifier

Applications

- DC-DC converters
- Switched-mode and resonant-mode power supplies, >500kHz switching
- DC choppers
- Pulse generation
- Laser drivers

Advantages

- PLUS 264™ package for clip or spring mounting
- Space savings
- High power density

| Symbol | Test Conditions | Characteristic Values ($T_J = 25^\circ C$, unless otherwise specified) | | |
|--------------|---|---|------|---|
| | | Min. | Typ. | Max. |
| BV_{DSS} | $V_{GS} = 0V$, $I_D = 1mA$ | 1000 | | V |
| $V_{GS(th)}$ | $V_{DS} = V_{GS}$, $I_D = 8mA$ | 3.0 | | 5.5 V |
| I_{GSS} | $V_{GS} = \pm 30V$, $V_{DS} = 0V$ | | | ± 200 nA |
| I_{DSS} | $V_{DS} = V_{DSS}$ $V_{GS} = 0V$ | | | 50 μA 3 mA $T_J = 125^\circ C$ |
| $R_{DS(on)}$ | $V_{GS} = 10V$, $I_D = 0.5 \cdot I_{D25}$, Note 1 | | | 250 m Ω |

| Symbol | Test Conditions ($T_J = 25^\circ\text{C}$, unless otherwise specified) | Characteristic Values | | |
|--------------|--|-----------------------|------|--------------------|
| | | Min. | Typ. | Max. |
| g_{fs} | $V_{DS} = 20\text{V}, I_D = 0.5 \cdot I_{D25}$, Note 1 | 24 | 40 | S |
| C_{iss} | $V_{GS} = 0\text{V}, V_{DS} = 25\text{V}, f = 1\text{MHz}$ | | 13.5 | nF |
| C_{oss} | | | 1035 | pF |
| C_{rss} | | | 180 | pF |
| $t_{d(on)}$ | Resistive Switching Times $V_{GS} = 10\text{V}, V_{DS} = 0.5 \cdot V_{DSS}, I_D = 0.5 \cdot I_{D25}$ $R_G = 1\Omega$ (External) | | 25 | ns |
| t_r | | | 28 | ns |
| $t_{d(off)}$ | | | 57 | ns |
| t_f | | | 15 | ns |
| $Q_{g(on)}$ | $V_{GS} = 10\text{V}, V_{DS} = 0.5 \cdot V_{DSS}, I_D = 0.5 \cdot I_{D25}$ | | 250 | nC |
| Q_{gs} | | | 60 | nC |
| Q_{gd} | | | 105 | nC |
| R_{thJC} | | | 0.14 | $^\circ\text{C/W}$ |
| R_{thCS} | | 0.13 | | $^\circ\text{C/W}$ |

Source-Drain Diode

| Symbol | Test Conditions ($T_J = 25^\circ\text{C}$, unless otherwise specified) | Characteristic Values | | |
|----------|---|-----------------------|------|---------------|
| | | Min. | Typ. | Max. |
| I_S | $V_{GS} = 0\text{V}$ | | | 38 A |
| I_{SM} | Repetitive, pulse width limited by T_{JM} | | | 152 A |
| V_{SD} | $I_F = I_S, V_{GS} = 0\text{V}$, Note 1 | | | 1.5 V |
| t_{rr} | $I_F = 25\text{A}, V_{GS} = 0\text{V}$ $-di/dt = 100\text{ A}/\mu\text{s}$ $V_R = 100\text{ V}$ | | | 300 ns |
| Q_{RM} | | | 1.4 | μC |
| I_{RM} | | | 9 | A |

Note: 1. Pulse test, $t \leq 300\mu\text{s}$, duty cycle, $d \leq 2\%$.

PLUS264™ (IXFB) Outline

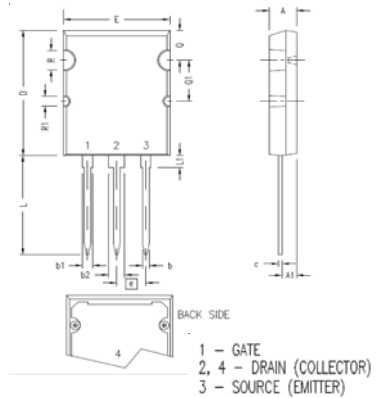

| SYM | INCHES | | MILLIMETERS | |
|-----|----------|-------|-------------|-------|
| | MIN | MAX | MIN | MAX |
| A | .185 | .209 | 4.70 | 5.31 |
| A1 | .102 | .118 | 2.59 | 3.00 |
| b | .037 | .055 | 0.94 | 1.40 |
| b1 | .087 | .102 | 2.21 | 2.59 |
| b2 | .110 | .126 | 2.79 | 3.20 |
| c | .017 | .029 | 0.43 | 0.74 |
| D | 1.007 | 1.047 | 25.58 | 26.59 |
| E | .760 | .799 | 19.30 | 20.29 |
| e | .215 BSC | | 5.46 BSC | |
| L | .779 | .842 | 19.79 | 21.39 |
| L1 | .087 | .102 | 2.21 | 2.59 |
| Q | .240 | .256 | 6.10 | 6.50 |
| Q1 | .330 | .346 | 8.38 | 8.79 |
| ØR | .155 | .187 | 3.94 | 4.75 |
| ØR1 | .085 | .093 | 2.16 | 2.36 |

IXYS reserves the right to change limits, test conditions, and dimensions.

| | | | | | | | | | | |
|--|-----------|-----------|-----------|-----------|--------------|--------------|--------------|--------------|--------------|-------------|
| IXYS MOSFETs and IGBTs are covered by one or more of the following U.S. patents: | 4,835,592 | 4,931,844 | 5,049,961 | 5,237,481 | 6,162,665 | 6,404,065 B1 | 6,683,344 | 6,727,585 | 7,005,734 B2 | 7,157,338B2 |
| | 4,850,072 | 5,017,508 | 5,063,307 | 5,381,025 | 6,259,123 B1 | 6,534,343 | 6,710,405 B2 | 6,759,692 | 7,063,975 B2 | |
| | 4,881,106 | 5,034,796 | 5,187,117 | 5,486,715 | 6,306,728 B1 | 6,583,505 | 6,710,463 | 6,771,478 B2 | 7,071,537 | |

Fig. 1. Output Characteristics @ 25°C

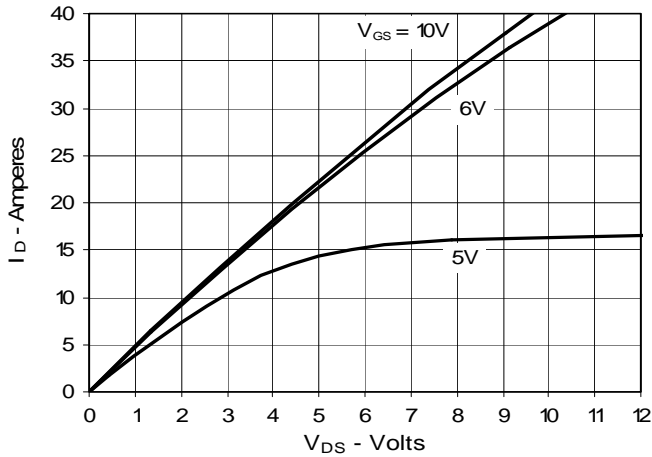

Fig. 2. Extended Output Characteristics @ 25°C

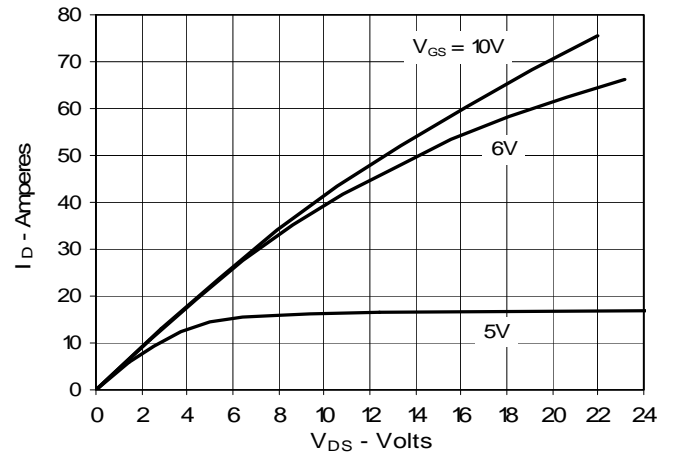

Fig. 3. Output Characteristics @ 125°C

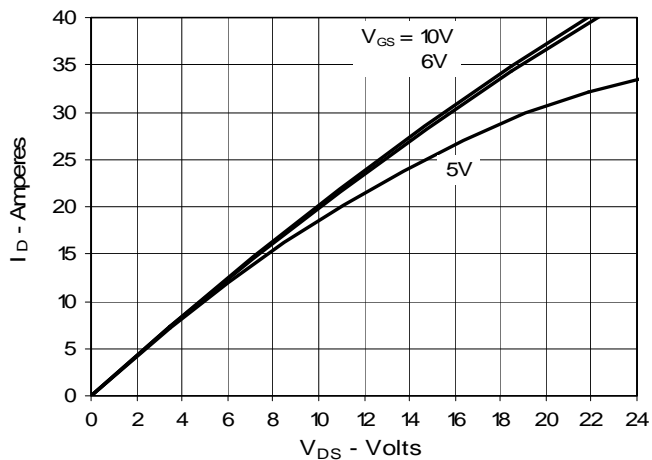

Fig. 4. $R_{DS(on)}$ Normalized to $I_D = 19A$ Value vs. Junction Temperature

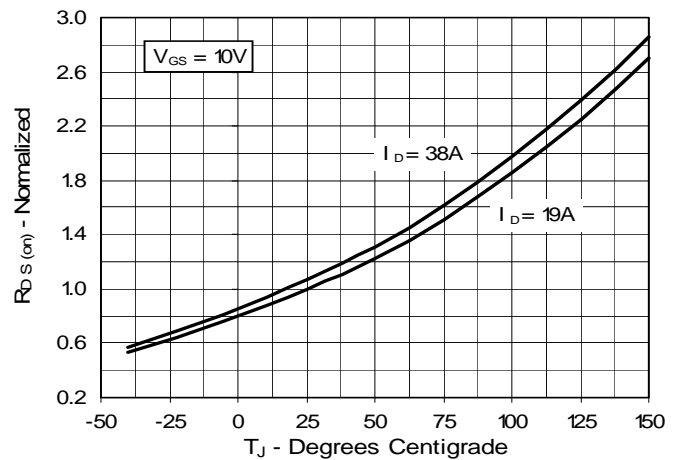

Fig. 5. $R_{DS(on)}$ Normalized to $I_D = 19A$ Value vs. Drain Current

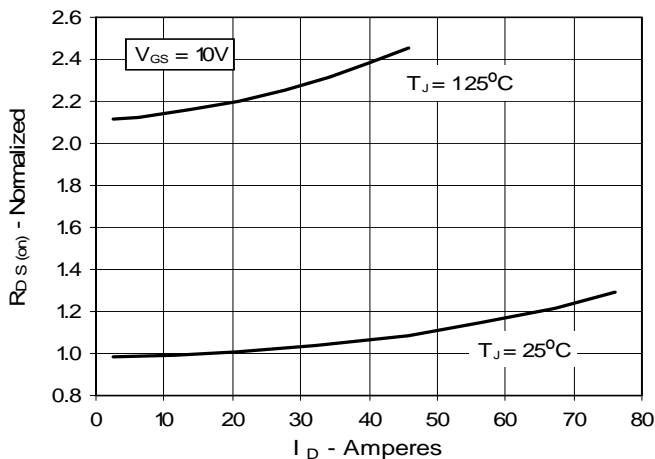

Fig. 6. Drain Current vs. Case Temperature

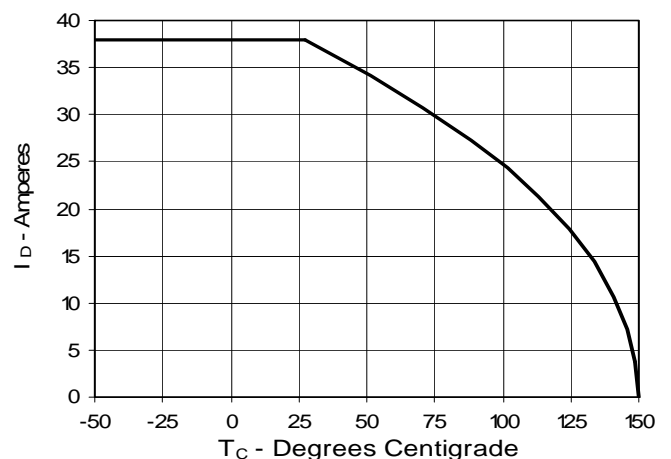

Fig. 7. Input Admittance

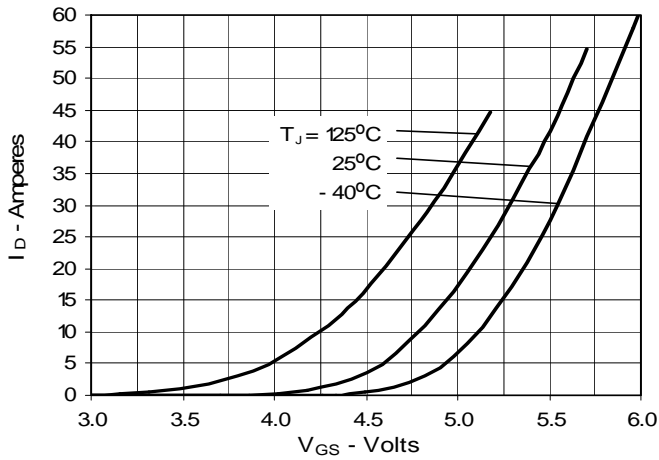

Fig. 8. Transconductance

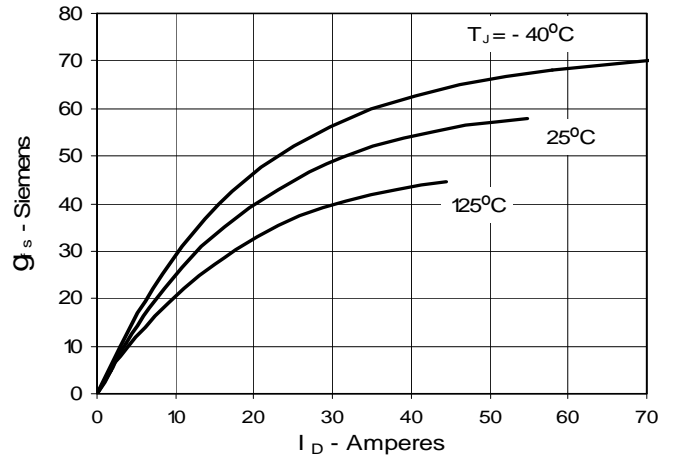

Fig. 9. Source Current vs. Source-To-Drain Voltage

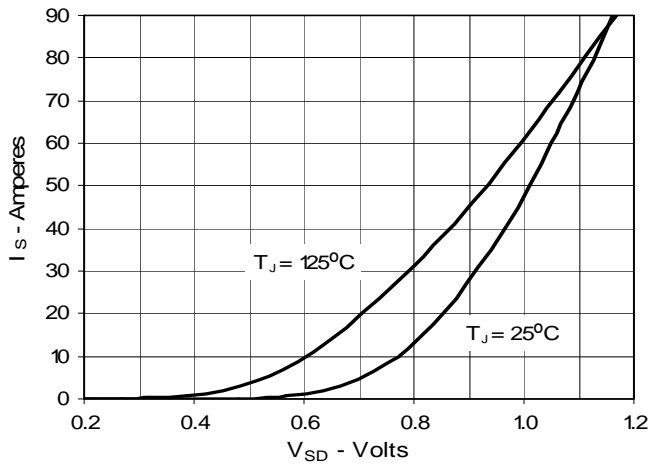

Fig. 10. Gate Charge

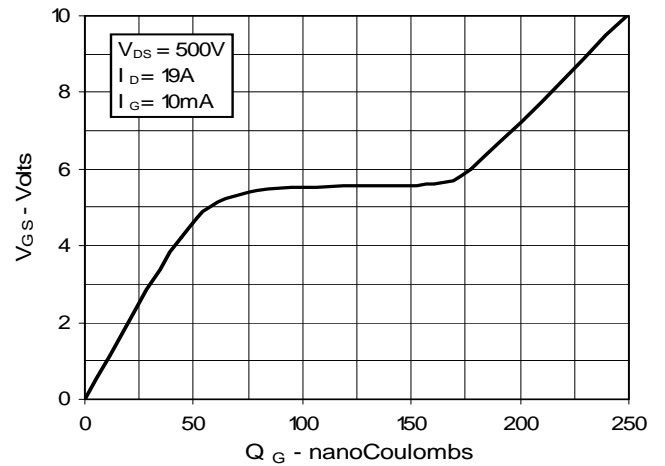

Fig. 11. Capacitance

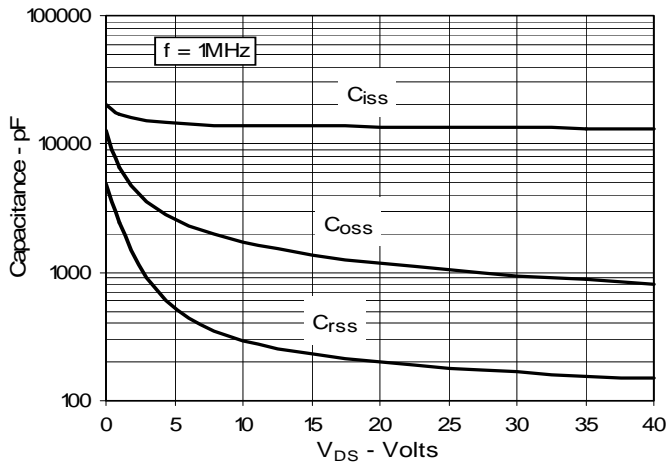
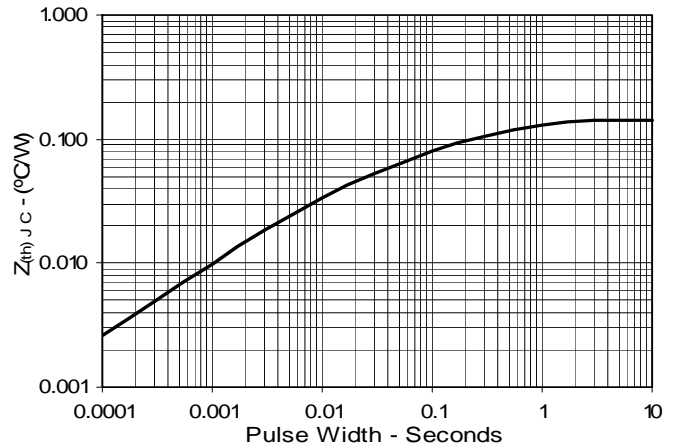

Fig. 12. Maximum Transient Thermal Impedance





Disclaimer Notice - Information furnished is believed to be accurate and reliable. However, users should independently evaluate the suitability of and test each product selected for their own applications. Littelfuse products are not designed for, and may not be used in, all applications. Read complete Disclaimer Notice at www.littelfuse.com/disclaimer-electronics.