

**Q6016xH1LED Series**

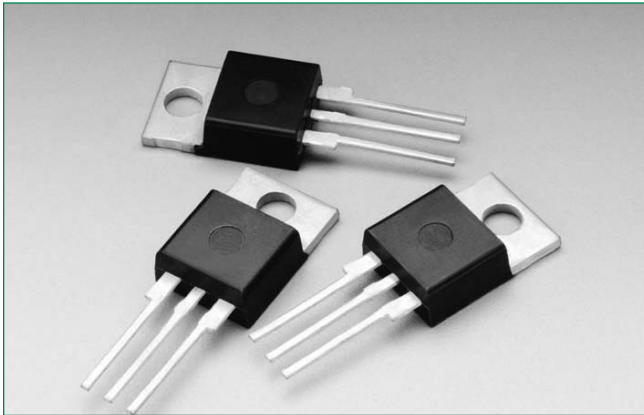

**Description**

Q6016LH1LED series is designed to meet low load current characteristics typical in LED lighting applications.

By keeping holding current at 5mA maximum, this Triac series is characterized and specified to perform best with LED loads. The Q6016LH1LED series is best suited for LED dimming controls to obtain the lowest levels of light output with a minimum probability of flickering.

Q6016LH1LED series is offered in the industry standard TO-220AB package with an isolated mounting tab that makes it best suited for adding an external heat sink.

**Agency Recognitions**

| Agency | Agency File Number |
|--------|--------------------|
|        | E71639             |

**Main Features**

| Symbol            | Value | Unit |
|-------------------|-------|------|
| $I_{T(RMS)}$      | 16    | A    |
| $V_{DRM}/V_{RRM}$ | 600   | V    |
| $I_{GT}$          | 5     | mA   |

**Features & Benefits**

- As low as 5 mA max holding current
- L-Package is UL Recognized for 2500Vrms
- di/dt performance of 100A/μs
- UL Recognized to UL 1557
- Provides full control of light out put at the extreme low end of load conditions.
- 2500V<sub>AC</sub> min isolation between mounting tab and active terminals
- Improves margin of safe operation with less heat sinking required
- Enable survivability of typically LED load operating characteristics
- Simplicity of circuit design & layout

**Schematic Symbol**

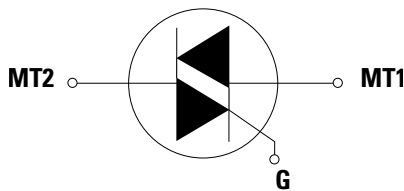

**Applications**

Excellent for AC switching and phase control applications such as heating, lighting, and motor speed controls.

Typical applications are AC solid-state switches, lighting controls with LED lamp loads, small low current motor in power tools, lower current motor in home/brown goods appliances.

Internally constructed isolated packages are offered for ease of heat sinking with highest isolation voltage.

#### Absolute Maximum Ratings

| Symbol       | Parameter  |  |                           | Value      | Unit                   |
|--------------|--|--|---------------------------|------------|------------------------|
| $I_{T(RMS)}$ | RMS on-state current (full sine wave)  | -  | $T_c = 90^\circ\text{C}$  | 16         | A                      |
| $I_{TSM}$    | Non repetitive surge peak on-state current (full cycle, $T_J$ initial = $25^\circ\text{C}$ ) | $f = 50\text{ Hz}$                                   | $t = 20\text{ ms}$        | 167        | A                      |
|              |  | $f = 60\text{ Hz}$                                   | $t = 16.7\text{ ms}$      | 200        |                        |
| $I^2t$       | $I^2t$ Value for fusing  | -  | $t_p = 8.3\text{ ms}$     | 166        | $\text{A}^2\text{s}$   |
| $di/dt$      | Critical rate of rise of on-state current  | $f = 60\text{ Hz}$                                   | $T_J = 125^\circ\text{C}$ | 100        | $\text{A}/\mu\text{s}$ |
| $I_{GTM}$    | Peak gate trigger current  | $t_p \leq 10\ \mu\text{s};$<br>$I_{GT} \leq I_{GTM}$ | $T_J = 125^\circ\text{C}$ | 2.0        | A                      |
| $P_{G(AV)}$  | Average gate power dissipation   |  | $T_J = 125^\circ\text{C}$ | 0.5        | W                      |
| $T_{stg}$    | Storage temperature range  |  |                           | -40 to 150 | $^\circ\text{C}$       |
| $T_J$        | Operating junction temperature range   |  |                           | -40 to 125 | $^\circ\text{C}$       |

#### Electrical Characteristics ( $T_J = 25^\circ\text{C}$ , unless otherwise specified)

| Symbol      | Test Conditions   | Quadrant     |      | Qxx16LH1 | Unit                   |
|-------------|---|--------------|------|----------|------------------------|
| $I_{GT}$    | $V_D = 12\text{ V}$ $R_L = 60\ \Omega$  | I – II – III | MAX. | 5        | mA                     |
| $V_{GT}$    |   | I – II – III | MAX. | 1.3      | V                      |
| $V_{GD}$    | $V_D = V_{DRM}$ $R_L = 3.3\text{ k}\Omega$ $T_J = 125^\circ\text{C}$            | I – II – III | MIN. | 0.2      | V                      |
| $I_H$       | $I_T = 20\text{ mA}$  |              | MAX. | 5        | mA                     |
| $dv/dt$     | $V_D = V_{DRM}$ Gate Open $T_J = 125^\circ\text{C}$                             |              | MIN. | 45       | $\text{V}/\mu\text{s}$ |
| $(dv/dt)_c$ | $(di/dt)_c = 8.6\text{ A/ms}$ $T_J = 125^\circ\text{C}$                         |              | MIN. | 2        | $\text{V}/\mu\text{s}$ |
| $t_{gt}$    | $I_G = 2 \times I_{GT}$ $\text{PW} = 15\ \mu\text{s}$ $I_T = 22.6\text{ A(pk)}$ |              | TYP. | 3        | $\mu\text{s}$          |

#### Static Characteristics

| Symbol                 | Test Conditions                                   |                           |      | Value | Unit          |
|------------------------|---|---------------------------|------|-------|---------------|
| $V_{TM}$               | $I_{TM} = 22.6\text{ A}$ $t_p = 380\ \mu\text{s}$ |                           | MAX. | 1.60  | V             |
| $I_{DRM}$<br>$I_{RRM}$ | $V_D = V_{DRM} / V_{RRM}$                         | $T_J = 25^\circ\text{C}$  | MAX. | 10    | $\mu\text{A}$ |
|                        |   | $T_J = 125^\circ\text{C}$ |      | 2     | mA            |

#### Thermal Resistances

| Symbol           | Parameter             | Value | Unit                      |
|------------------|-----------------------|-------|---------------------------|
| $R_{\theta(JC)}$ | Junction to case (AC) | 2.1   | $^\circ\text{C}/\text{W}$ |
| $R_{\theta(JA)}$ | Junction to ambient   | 50    | $^\circ\text{C}/\text{W}$ |

Note: xx = voltage

**Figure 1: Definition of Quadrants**

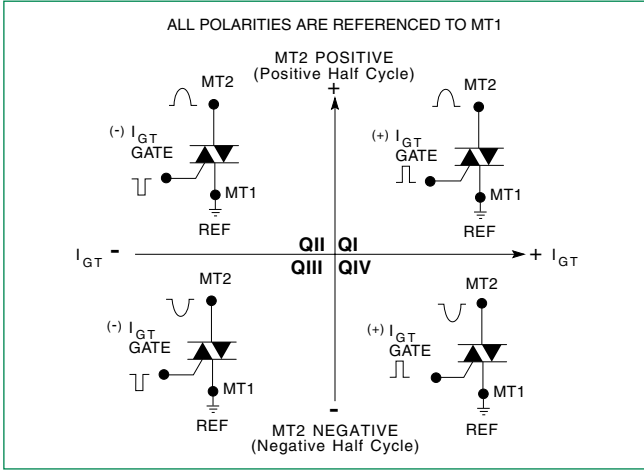

Note: Alternistors will not operate in QIV

**Figure 3: Normalized DC Holding Current vs. Junction Temperature**

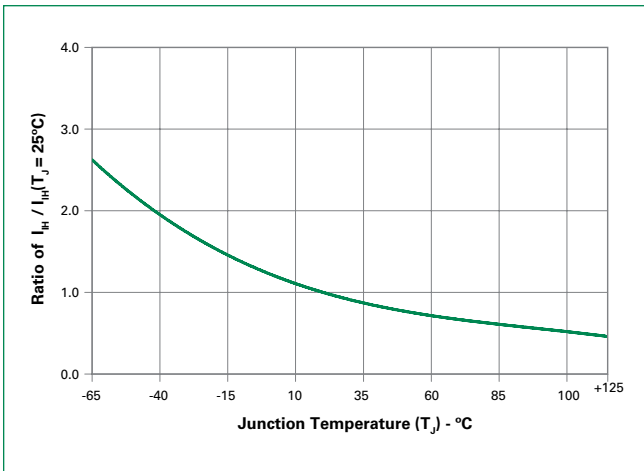

**Figure 5: Power Dissipation (Typical) vs. RMS On-State Current**

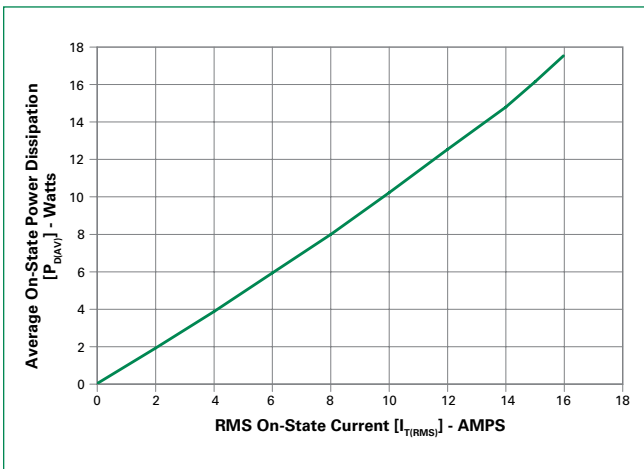

**Figure 2: Normalized DC Gate Trigger Current for All Quadrants vs. Junction Temperature**

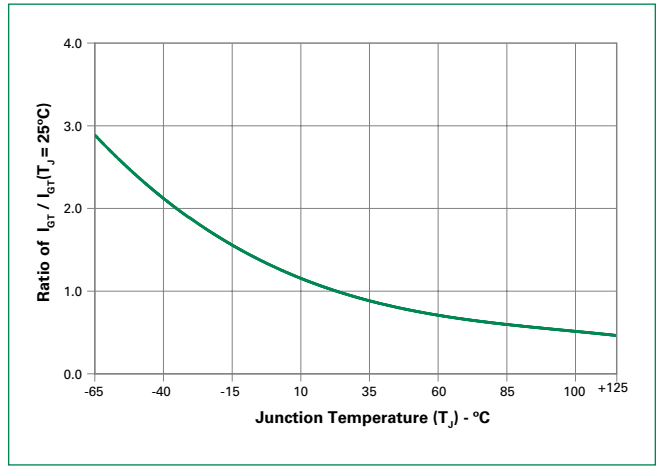

**Figure 4: Normalized DC Gate Trigger Voltage for All Quadrants vs. Junction Temperature**

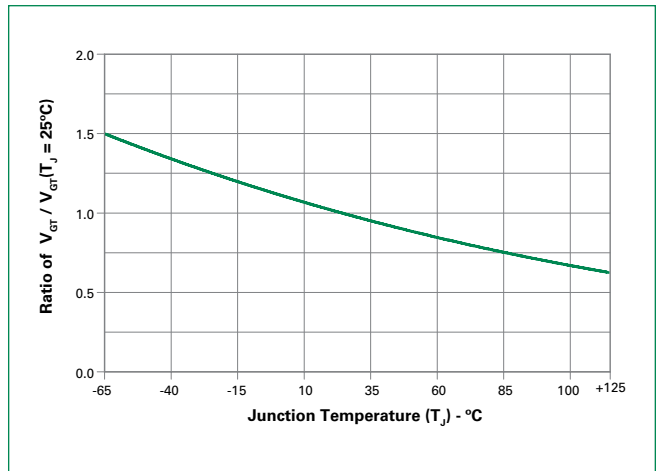

**Figure 6: Maximum Allowable Case Temperature vs. On-State Current**

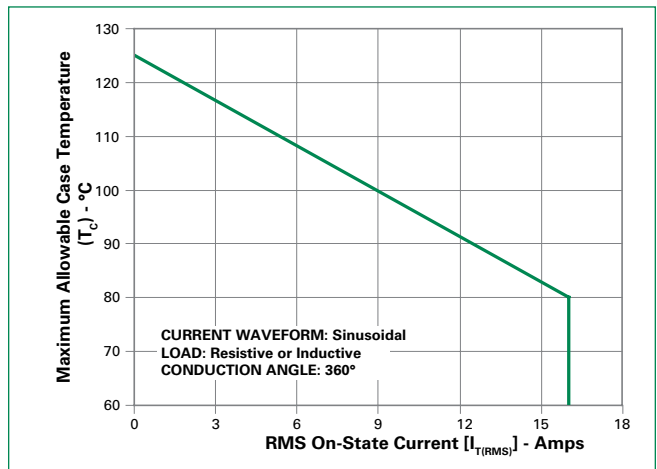

**Figure 8: On-State Current vs. On-State Voltage (Typical)**

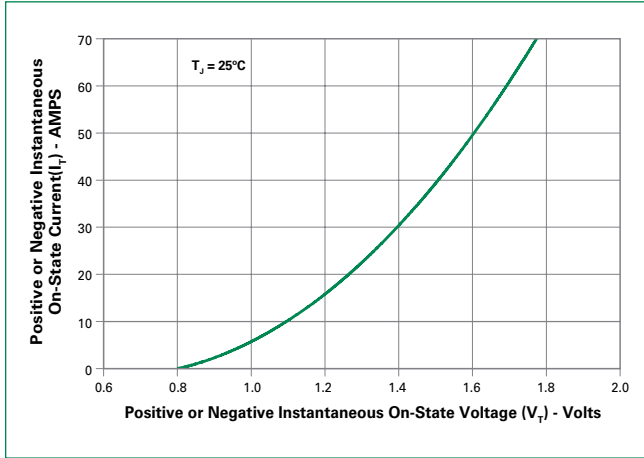

**Figure 9: Surge Peak On-State Current vs. Number of Cycles**

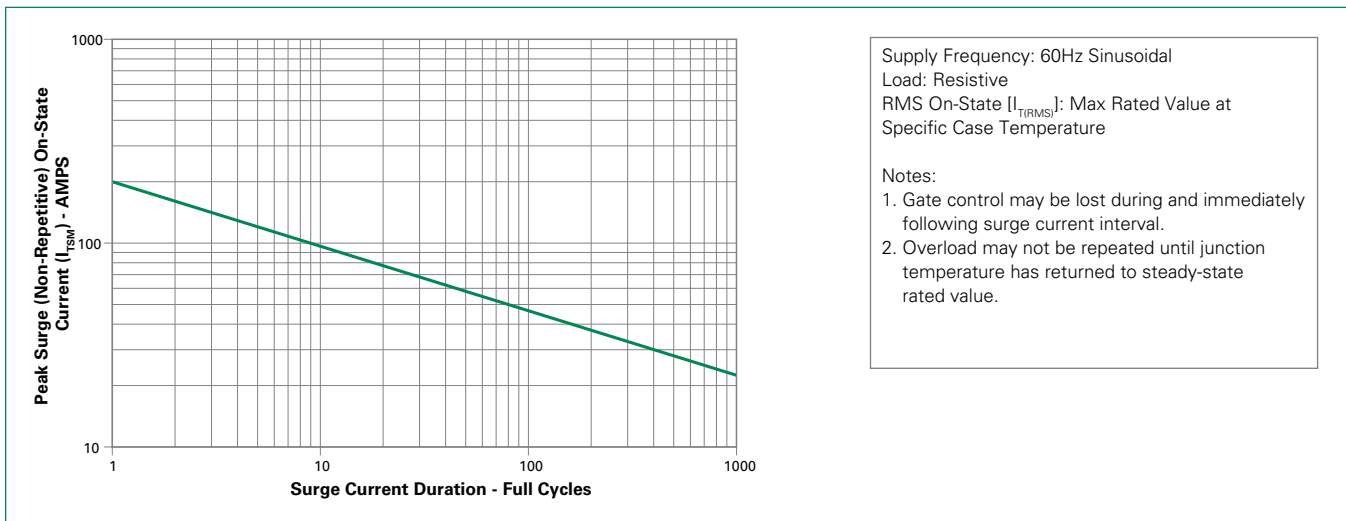

Supply Frequency: 60Hz Sinusoidal  
 Load: Resistive  
 RMS On-State ( $I_{TRMS}$ ): Max Rated Value at Specific Case Temperature

Notes:  
 1. Gate control may be lost during and immediately following surge current interval.  
 2. Overload may not be repeated until junction temperature has returned to steady-state rated value.

### Soldering Parameters

|  |                                    |                         |
|--|------------------------------------|-------------------------|
| <b>Reflow Condition</b>  |                                    | Pb – Free assembly      |
| <b>Pre Heat</b>  | - Temperature Min ( $T_{s(min)}$ ) | 150°C                   |
|  | - Temperature Max ( $T_{s(max)}$ ) | 200°C                   |
|  | - Time (min to max) ( $t_s$ )      | 60 – 180 secs           |
| <b>Average ramp up rate (Liquidus Temp) (<math>T_L</math>) to peak</b> |                                    | 5°C/second max          |
| <b><math>T_{s(max)}</math> to <math>T_L</math> - Ramp-up Rate</b>      |                                    | 5°C/second max          |
| <b>Reflow</b>  | - Temperature ( $T_L$ ) (Liquidus) | 217°C                   |
|  | - Time (min to max) ( $t_s$ )      | 60 – 150 seconds        |
| <b>Peak Temperature (<math>T_p</math>)</b>                             |                                    | 260 <sup>+0/-5</sup> °C |
| <b>Time within 5°C of actual peak Temperature (<math>t_p</math>)</b>   |                                    | 20 – 40 seconds         |
| <b>Ramp-down Rate</b>  |                                    | 5°C/second max          |
| <b>Time 25°C to peak Temperature (<math>T_p</math>)</b>                |                                    | 8 minutes Max.          |
| <b>Do not exceed</b>   |                                    | 280°C                   |

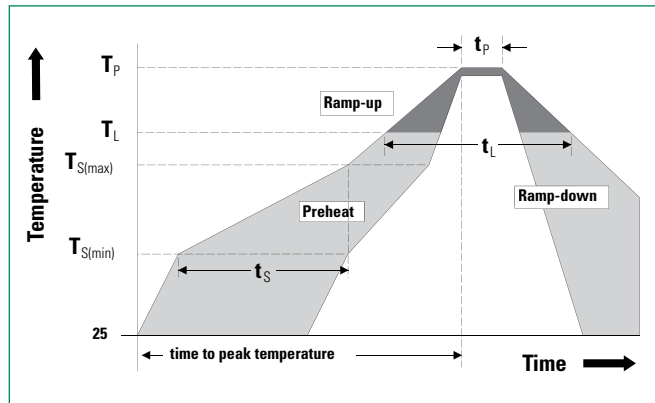

### Physical Specifications

|                          |  |
|--------------------------|--|
| <b>Terminal Finish</b>   | 100% Matte Tin-plated                                  |
| <b>Body Material</b>     | UL Recognized compound meeting flammability rating V-0 |
| <b>Terminal Material</b> | Copper Alloy   |

### Design Considerations

Careful selection of the correct component for the application's operating parameters and environment will go a long way toward extending the operating life of the Thyristor. Good design practice should limit the maximum continuous current through the main terminals to 75% of the component rating. Other ways to ensure long life for a power discrete semiconductor are proper heat sinking and selection of voltage ratings for worst case conditions. Overheating, overvoltage (including  $dv/dt$ ), and surge currents are the main killers of semiconductors. Correct mounting, soldering, and forming of the leads also help protect against component damage.

### Environmental Specifications

| Test                             | Specifications and Conditions  |
|----------------------------------|--|
| <b>AC Blocking</b>               | MIL-STD-750, M-1040, Cond A Applied Peak AC voltage @ 110°C for 1008 hours |
| <b>Temperature Cycling</b>       | MIL-STD-750, M-1051, 100 cycles; -40°C to +150°C; 15-min dwell time        |
| <b>Temperature/Humidity</b>      | EIA / JEDEC, JESD22-A101 1008 hours; 320V - DC; 85°C; 85% rel humidity     |
| <b>High Temp Storage</b>         | MIL-STD-750, M-1031, 1008 hours; 150°C                                     |
| <b>Low-Temp Storage</b>          | 1008 hours; -40°C  |
| <b>Autoclave</b>                 | EIA / JEDEC, JESD22-A102 168 hours (121°C at 2 ATMs) and 100% R/H          |
| <b>Resistance to Solder Heat</b> | MIL-STD-750 Method 2031  |
| <b>Solderability</b>             | ANSI/J-STD-002, category 3, Test A   |
| <b>Lead Bend</b>                 | MIL-STD-750, M-2036 Cond E   |

### Dimensions — TO-220AB (L-Package) — Isolated Mounting Tab

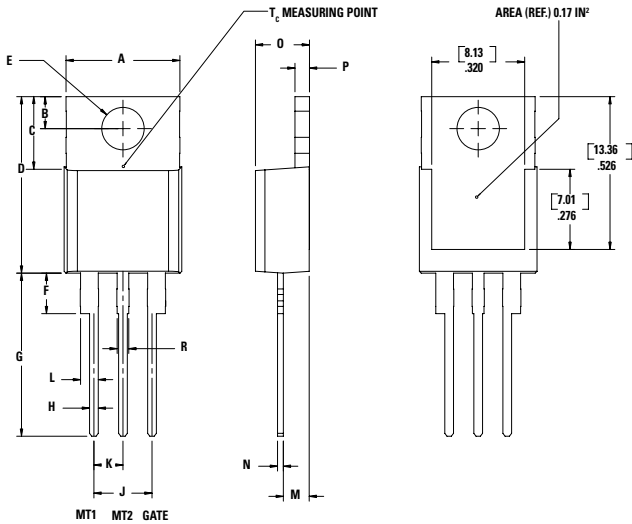

| Dimension | Inches |       | Millimeters |       |
|-----------|--------|-------|-------------|-------|
|           | Min    | Max   | Min         | Max   |
| A         | 0.380  | 0.420 | 9.65        | 10.67 |
| B         | 0.105  | 0.115 | 2.67        | 2.92  |
| C         | 0.230  | 0.250 | 5.84        | 6.35  |
| D         | 0.590  | 0.620 | 14.99       | 15.75 |
| E         | 0.142  | 0.147 | 3.61        | 3.73  |
| F         | 0.110  | 0.130 | 2.79        | 3.30  |
| G         | 0.540  | 0.575 | 13.72       | 14.61 |
| H         | 0.025  | 0.035 | 0.64        | 0.89  |
| J         | 0.195  | 0.205 | 4.95        | 5.21  |
| K         | 0.095  | 0.105 | 2.41        | 2.67  |
| L         | 0.060  | 0.075 | 1.52        | 1.91  |
| M         | 0.085  | 0.095 | 2.16        | 2.41  |
| N         | 0.018  | 0.024 | 0.46        | 0.61  |
| O         | 0.178  | 0.188 | 4.52        | 4.78  |
| P         | 0.045  | 0.060 | 1.14        | 1.52  |
| R         | 0.038  | 0.048 | 0.97        | 1.22  |

### Product Selector

| Part Number | Gate Sensitivity Quadrants | Type              | Package |
|-------------|----------------------------|-------------------|---------|
|             | I - II - III               |                   |         |
| Q6016LH1LED | 5 mA                       | Alternistor Triac | TO-220L |

### Packing Options

| Part Number   | Marking  | Weight | Packing Mode | Base Quantity     |
|---------------|----------|--------|--------------|-------------------|
| Q6016LH1LEDTP | Q6016LH1 | 2.2 g  | Tube Pack    | 500 (50 per tube) |

### Part Numbering System

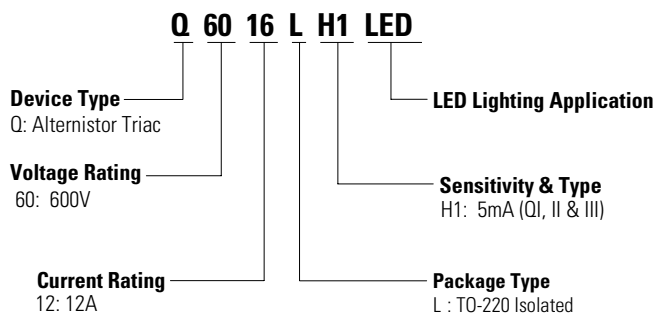

### Part Marking System

TO-220 AB - (L Package)

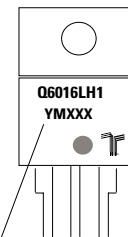

**Date Code Marking**  
 Y: Year Code  
 M: Month Code  
 XXX: Lot Trace Code