

# MAC16DG, MAC16MG, MAC16NG

## TRIAC – 400V - 800V

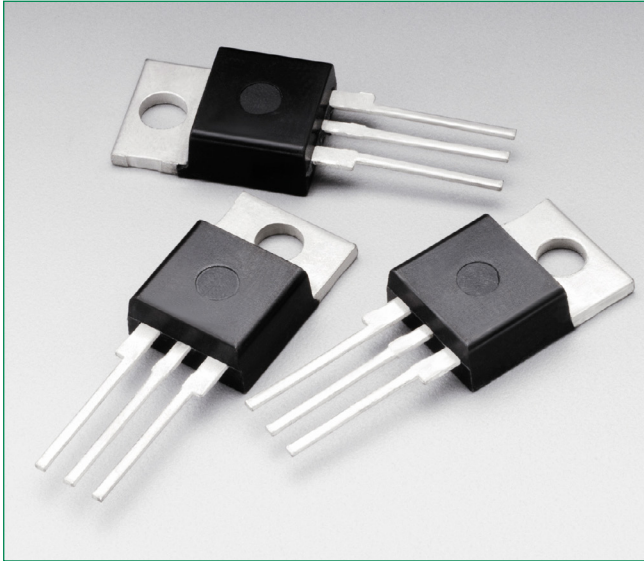

### Description

The MAC16 Series is designed for high performance full-wave ac control applications where high noise immunity and high commutating di/dt are required.

### Features

- Blocking Voltage to 800 Volts
- On-State Current Rating of 16 Amperes RMS at 80°C
- Uniform Gate Trigger Currents in Three Quadrants
- High Immunity to dv/dt – 500 V/μs minimum at 125°C
- Minimizes Snubber Networks for Protection
- Industry Standard TO–220 Package
- High Commutating di/dt – 9.0 A/ms minimum at 125°C
- These Devices are Pb–Free and are RoHS Compliant

### Additional Information



Resources



Accessories



Samples

### Functional Diagram

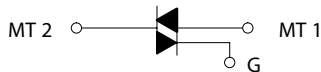

### Pin Out

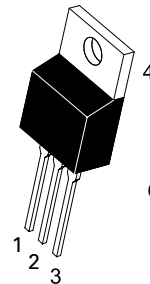

TO–220AB  
CASE 221A  
STYLE 4

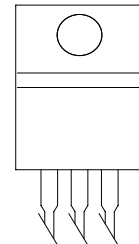

# MAC16DG, MAC16MG, MAC16NG

## TRIAC – 400V - 800V

### Maximum Ratings (T<sub>J</sub> = 25°C unless otherwise noted)

Rating	Symbol	Value	Unit
Peak Repetitive Off-State Voltage (Note 1) (– 40 to 125°C, Sine Wave, 50 to 60 Hz, Gate Open)	MAC16D MAC16M MAC16N $V_{DRM}$ $V_{RRM}$	400 600 800	V
On-State RMS Current (Full Cycle Sine Wave, 60 Hz, T <sub>C</sub> = 80°C)	$I_{T(RMS)}$	16	A
Peak Non-Repetitive Surge Current (One Full Cycle Sine Wave, 60 Hz, T <sub>C</sub> = 125°C)	$I_{TSM}$	150	A
Circuit Fusing Consideration (t = 8.3 ms)	$I^2t$	93	A <sup>2</sup> sec
Peak Gate Power (T <sub>C</sub> = 80°C, Pulse Width ≤ 1.0 μs)	$P_{GM}$	20	W
Average Gate Power (t = 8.3 ms, T <sub>C</sub> = 80°C)	$P_{G(AV)}$	0.5	W
Operating Junction Temperature Range	T <sub>J</sub>	–40 to +125	°C
Storage Temperature Range	T <sub>stg</sub>	–40 to +150	°C

Stresses exceeding Maximum Ratings may damage the device. Maximum Ratings are stress ratings only. Functional operation above the Recommended Operating Conditions is not implied. Extended exposure to stresses above the Recommended Operating Conditions may affect device reliability.

- $V_{DRM}$  and  $V_{RRM}$  for all types can be applied on a continuous basis. Ratings apply for zero or negative gate voltage; however, positive gate voltage shall not be applied concurrent with negative potential on the anode. Blocking voltages shall not be tested with a constant current source such that the voltage ratings of the devices are exceeded.

### Thermal Characteristics

Rating	Symbol	Value	Unit
Thermal Resistance, Junction-to-Case (AC) Junction-to-Ambient	$R_{\theta JC}$ $R_{\theta JA}$	2.0 62.5	°C/W
Maximum Lead Temperature for Soldering Purposes, 1/8" from case for 10 seconds	T <sub>L</sub>	260	°C

### Electrical Characteristics - OFF (T<sub>J</sub> = 25°C unless otherwise noted ; Electricals apply in both directions)

Characteristic	Symbol	Min	Typ	Max	Unit
Peak Repetitive Blocking Current (V <sub>D</sub> = V <sub>DRM</sub> = V <sub>RRM</sub> ; Gate Open)	T <sub>J</sub> = 25°C T <sub>J</sub> = 125°C $I_{DRM}$ $I_{RRM}$	-	-	0.01	mA
		-	-	2.0	

### Electrical Characteristics - ON (T<sub>J</sub> = 25°C unless otherwise noted; Electricals apply in both directions)

Characteristic	Symbol	Min	Typ	Max	Unit
Peak On-State Voltage (Note 2) (I <sub>TM</sub> = ±21 A Peak)	V <sub>TM</sub>	–	1.2	1.6	V
Gate Trigger Current (Continuous dc) (V <sub>D</sub> = 12 V, R <sub>L</sub> = 100 Ω)	MT2(+), G(+) MT2(+), G(–) MT2(–), G(–) $I_{GT}$	10	16	50	mA
Gate Trigger Voltage (Continuous dc) (V <sub>D</sub> = 12 V, R <sub>L</sub> = 100 Ω)	MT2(+), G(+) MT2(+), G(–) MT2(–), G(–) $V_{GT}$	0.5	0.75	1.5	
Latching Current (V <sub>D</sub> = 24 V, I <sub>G</sub> = 50 mA)	MT2(+), G(+) MT2(+), G(–) MT2(–), G(–) $V_{GD}$	–	33	50	
Holding Current (V <sub>D</sub> = 12 V <sub>dc</sub> , Gate Open, Initiating Current = ±150 mA)	$I_H$	–	20	50	mA

Product parametric performance is indicated in the Electrical Characteristics for the listed test conditions, unless otherwise noted. Product performance may not be indicated by the Electrical Characteristics if operated under different conditions.

- Indicates Pulse Test: Pulse Width ≤ 2.0 ms, Duty Cycle ≤ 2%.

# MAC16DG, MAC16MG, MAC16NG

## TRIAC – 400V - 800V

### Dynamic Characteristics

Characteristic	Symbol	Min	Typ	Max	Unit
Rate of Change of Commutating Current, See Figure 10. (VD = 400V, ITM = 6.0 A, Commutating dv/dt = 24 V/μs, Gate Open, TJ = 125°C, f = 250 Hz, No Snubber)	(di/dt)c	9.0	–	–	A/ms
Critical Rate of Rise of Off-State Voltage (VD = Rated V <sub>DRM</sub> , Exponential Waveform, Gate Open, TJ = 125°C)	dv/dt	500	–	–	V/μs

### Voltage Current Characteristic of SCR

Symbol	Parameter
V <sub>DRM</sub>	Peak Repetitive Forward Off State Voltage
I <sub>DRM</sub>	Peak Forward Blocking Current
V <sub>RRM</sub>	Peak Repetitive Reverse Off State Voltage
I <sub>RRM</sub>	Peak Reverse Blocking Current
V <sub>TM</sub>	Maximum On State Voltage
I <sub>H</sub>	Holding Current

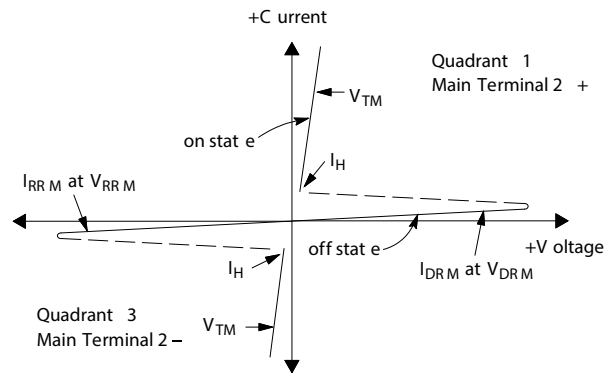

### Quadrant Definitions for a Triac

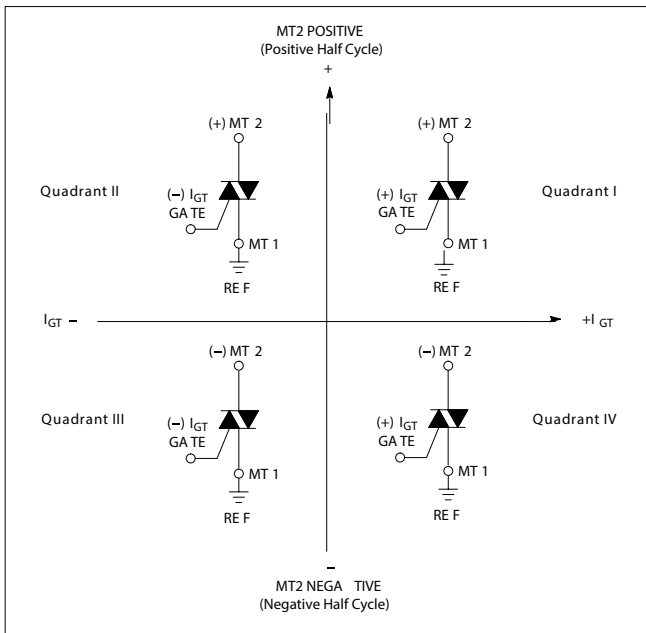

All polarities are referenced to MT1.  
With in-phase signals (using standard AC lines) quadrants I and III are used

# MAC16DG, MAC16MG, MAC16NG

## TRIAC – 400V - 800V

Figure 1. RMS Current Derating

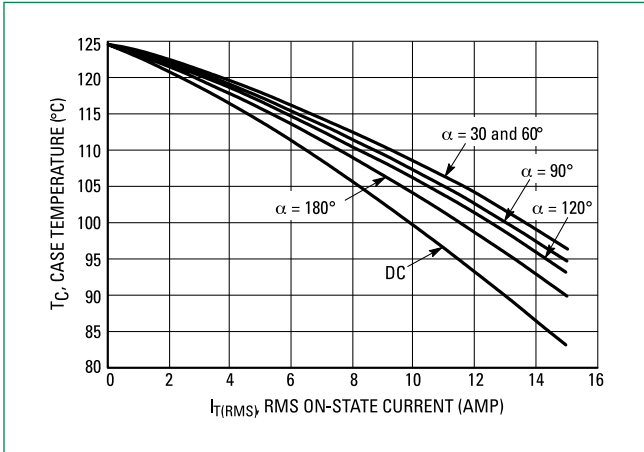

Figure 2. On-State Power Dissipation

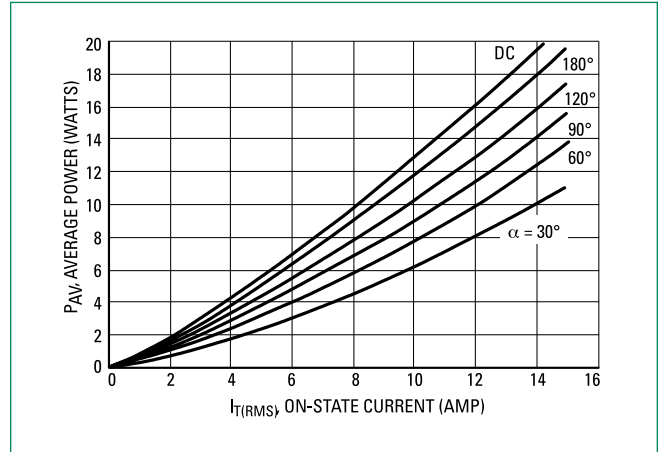

Figure 3. On-State Characteristics

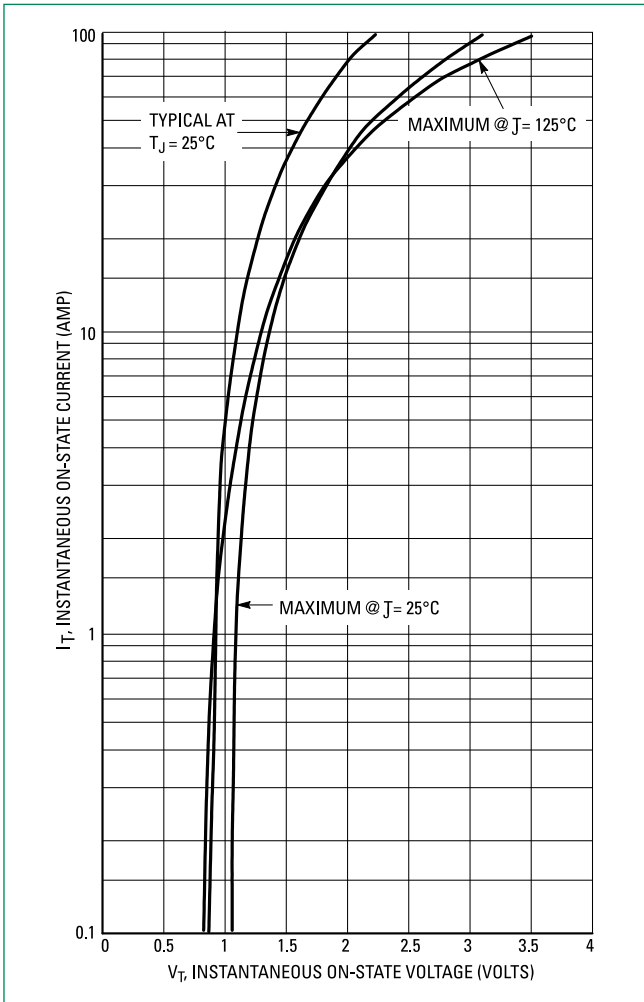

Figure 4. Thermal Response

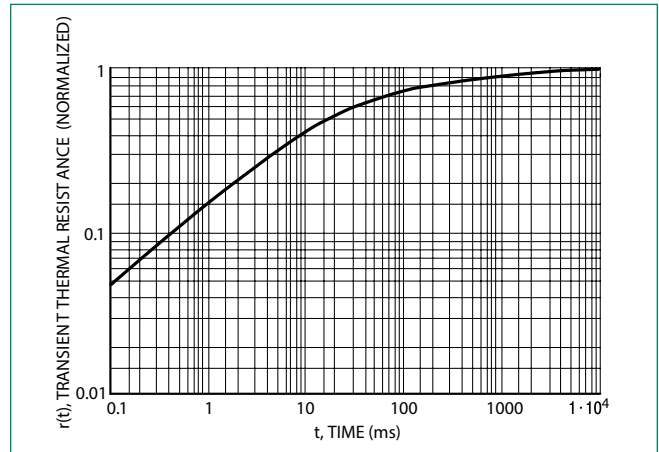
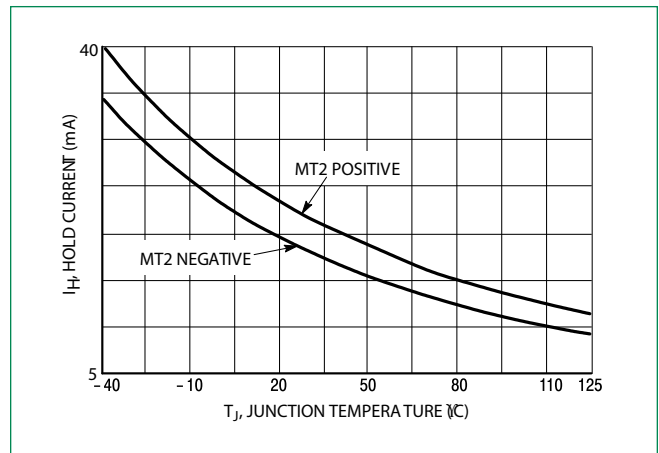

Figure 5. Hold Current Variation



# MAC16DG, MAC16MG, MAC16NG

## TRIAC – 400V - 800V

Figure 6. Typical Holding Current vs Junction Temperature

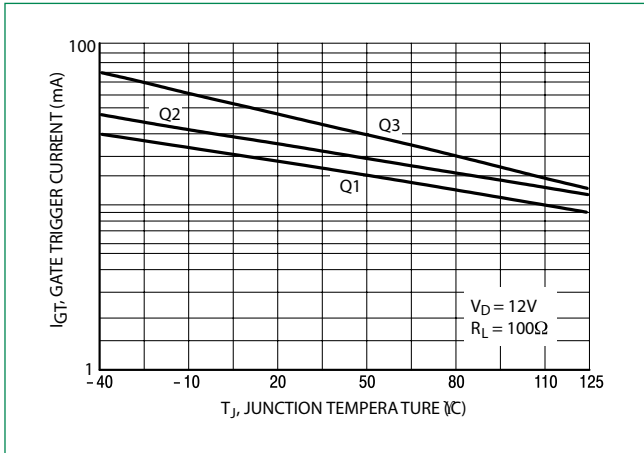

Figure 7. Gate Trigger Voltage vs Junction Temperature

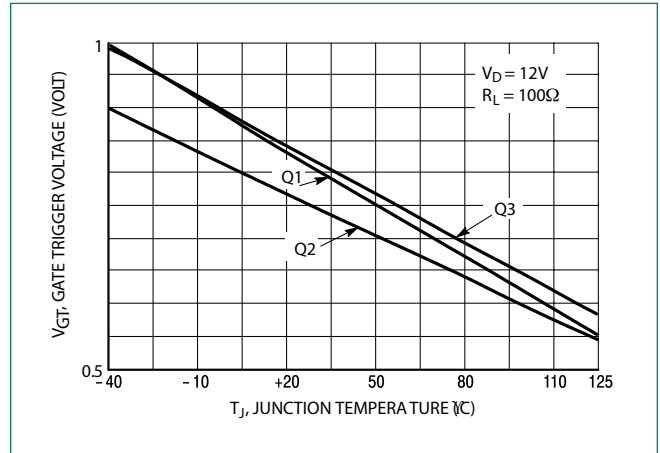

Figure 8. Critical Rate of Rise of Off-State Voltage (Exponential)

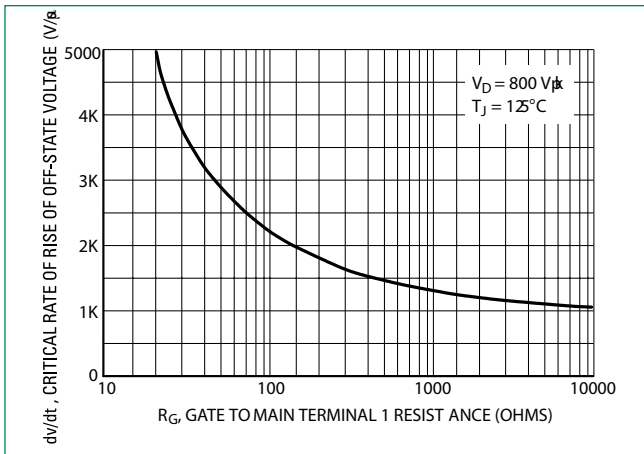

Figure 9. Critical Rate of Rise of Commutating Voltage

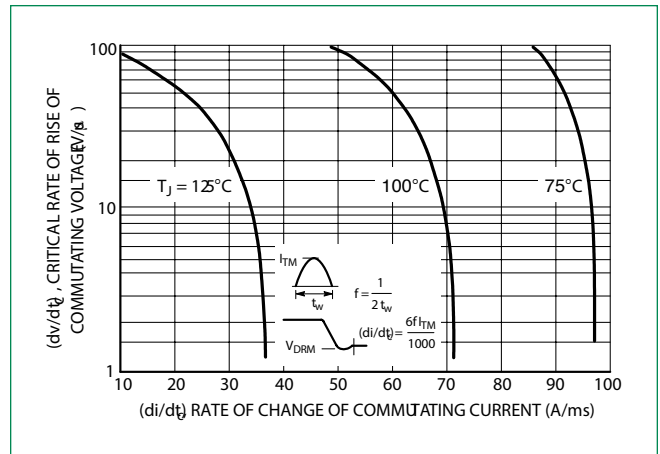
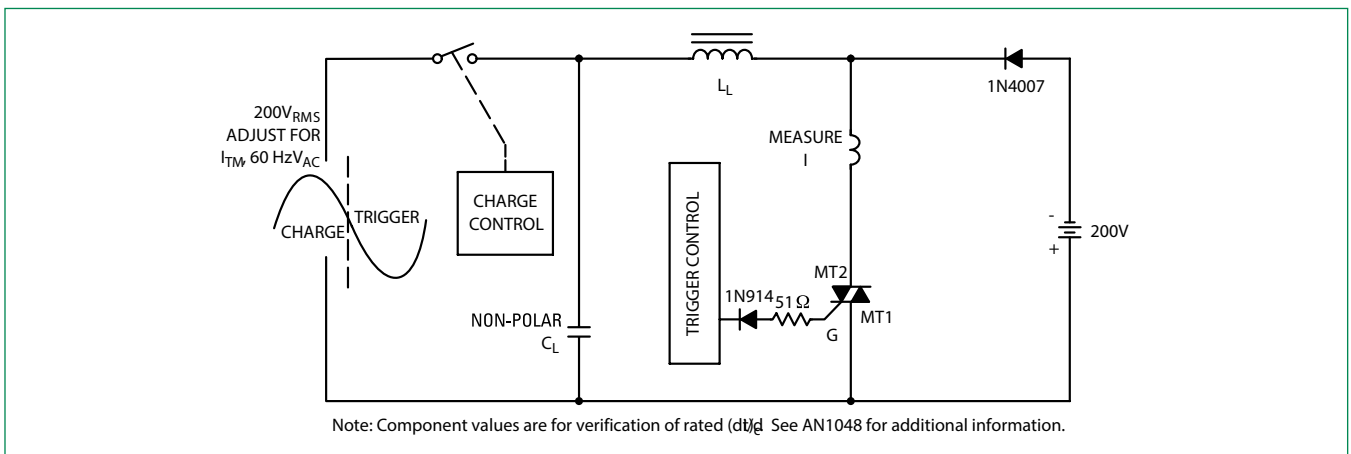

Figure 10. Simplified Test Circuit to Measure the Critical Rate of Rise of Commutating Current (di/dt)c



# MAC16DG, MAC16MG, MAC16NG

## TRIAC – 400V - 800V

### Dimensions

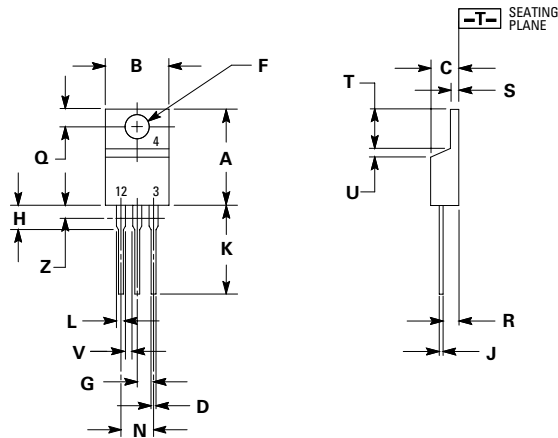

### Part Marking System

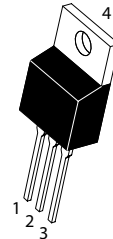

**TO-220AB  
CASE 221A  
STYLE 12**

x =D, M or N  
Y =Year  
M =Month  
A =Assembly Site  
XX =Lot Serial Code  
G =Pb-Free Package

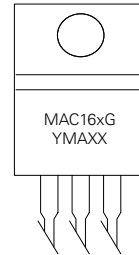

Dim	Inches		Millimeters	
	Min	Max	Min	Max
A	0.590	0.620	14.99	15.75
B	0.380	0.420	9.65	10.67
C	0.178	0.188	4.52	4.78
D	0.025	0.035	0.64	0.89
F	0.142	0.147	3.61	3.73
G	0.095	0.105	2.41	2.67
H	0.110	0.130	2.79	3.30
J	0.018	0.024	0.46	0.61
K	0.540	0.575	13.72	14.61
L	0.060	0.075	1.52	1.91
N	0.195	0.205	4.95	5.21
Q	0.105	0.115	2.67	2.92
R	0.085	0.095	2.16	2.41
S	0.045	0.060	1.14	1.52
T	0.235	0.255	5.97	6.47
U	0.000	0.050	0.00	1.27
V	0.045	---	1.15	---
Z	---	0.080	---	2.04

1. Dimensioning and tolerancing per ansi y14.5m, 1982.
2. Controlling dimension: inch.
3. Dimension z defines a zone where all body and lead irregularities are allowed.

Pin Assignment	
1	Main Terminal 1
2	Main Terminal 2
3	Gate
4	Main Terminal 2

### Ordering Information

Device	Package	Shipping
MAC16DG	TO-220 (Pb-Free)	1000 Units/ Box
MAC16MG		
MAC16NG		

**Disclaimer Notice** - Information furnished is believed to be accurate and reliable. However, users should independently evaluate the suitability of and test each product selected for their own applications. Littelfuse products are not designed for, and may not be used in, all applications. Read complete Disclaimer Notice at <http://www.littelfuse.com/disclaimer-electronics>.