

SP2525NUTG, 2.5V, 30A Diode Array

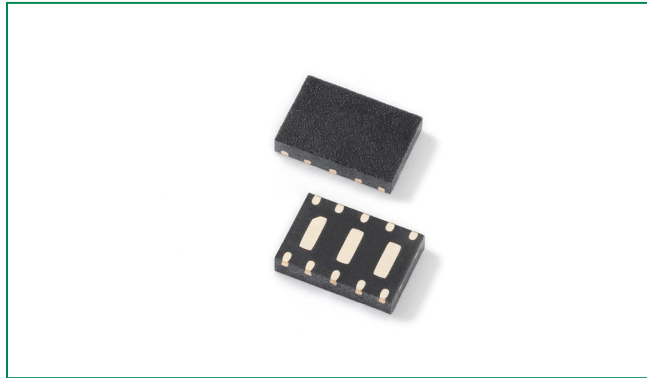

Description

The SP2525NUTG is a low-capacitance, TVS Diode Array designed to provide protection against ESD (electrostatic discharge), CDE (cable discharge events), EFT (electrical fast transients), and lightning induced surges for highspeed, differential data lines. It's packaged in a μDFN package (3.0 x 2.0mm) and each device can protect up to 4 channels up to 30A (IEC 61000-4- 5 2nd edition,) and up to ±30kV ESD (IEC 61000-4-2).

The SP2525NUTG with its low capacitance and low clamping voltage makes it ideal for high-speed data interfaces such as 1GbE applications found in notebooks, switches, etc.

Pinout

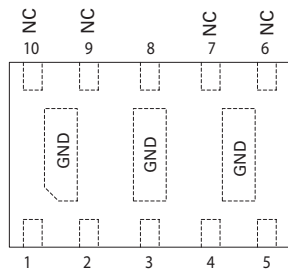

Note: PIN3 and PIN8 are same potential with GND

Top View

Features

- ESD, IEC 61000-4-2, ±30kV contact, ±30kV air
- EFT, IEC 61000-4-4, 40A (5/50ns)
- Lightning, IEC 61000-4-5 2nd edition, 30A (t_p=8/20μs)
- Low capacitance of 1.7pF@0V (TYP)
- Low leakage current of 1nA (TYP) at 2.5V
- Low operating and clamping voltage
- μDFN-10 package is optimized for high-speed data line routing
- Provides protection for two differential data pairs (4 channels) up to 30A
- Halogen free, Lead free and RoHS compliant
- Moisture Sensitivity Level (MSL -1)

Functional Block Diagram

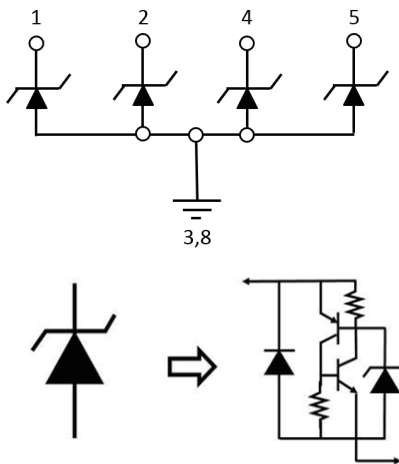

Applications

- 10/100/1000 Ethernet
- WAN/LAN Equipment
- Desktops, Servers and Notebooks
- LVDS Interfaces
- Integrated Magnetics
- Smart TV
- 2.5G/5G/10G Ethernet

Life Support Note:

Not Intended for Use in Life Support or Life Saving Applications

The products shown herein are not designed for use in life sustaining or life saving applications unless otherwise expressly indicated.

Absolute Maximum Ratings

Symbol	Parameter	Value	Units
I_{PP}	Peak Current ($t_p=8/20\mu s$)	30	A
T_{OP}	Operating Temperature	-40 to 125	°C
T_{STOR}	Storage Temperature	-55 to 150	°C

Notes:

CAUTION: Stresses above those listed in "Absolute Maximum Ratings" may cause permanent damage to the component. This is a stress only rating and operation of the component at these or any other conditions above those indicated in the operational sections of this specification is not implied.

Electrical Characteristics ($T_{OP}=25^\circ C$)

Parameter	Symbol	Test Conditions	Min	Typ	Max	Units
Reverse Standoff Voltage	V_{RWM}	$I_R = 1\mu A$			2.5	V
Breakdown Voltage	V_{BR}	$I_R = 1mA$	5.5	7.0		V
Reverse Leakage Current	I_{LEAK}	$V_R=2.5V$		1	100	nA
Holding Voltage	V_{HOLD}	I/O to GND		1.6		V
Clamp Voltage ¹	V_C	$I_{PP}=30A, t_p=8/20\mu s$		9	11	V
Dynamic Resistance ²	R_{DYN}	TLP, $t_p=100ns$		0.14		Ω
ESD Withstand Voltage ^{1,3}	V_{ESD}	IEC 61000-4-2 (Contact Discharge)	± 30			kV
		IEC 61000-4-2 (Air Discharge)	± 30			kV
Diode Capacitance ¹	$C_{I/O-GND}$	Reverse Bias=0V, f=1MHz		1.7	2.5	pF

Notes:

1Parameter is guaranteed by design and/or component characterization.

2 Transmission Line Pulse (TLP) test setting : Std. TDR(50 Ω), $t_p=100ns$, $t_r=0.2ns$ ITLP and VTLP averaging window: start $t_1=70ns$ to end $t_2=90ns$

3. Device stressed with ten non-repetitive ESD pulses.

8/20 μs Pulse Waveform

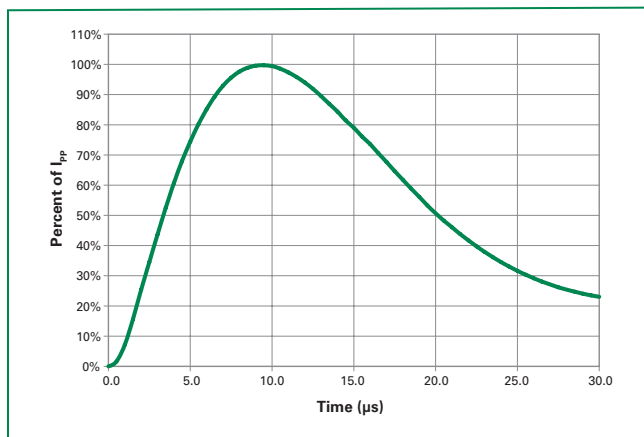

Capacitance vs. Reverse Bias

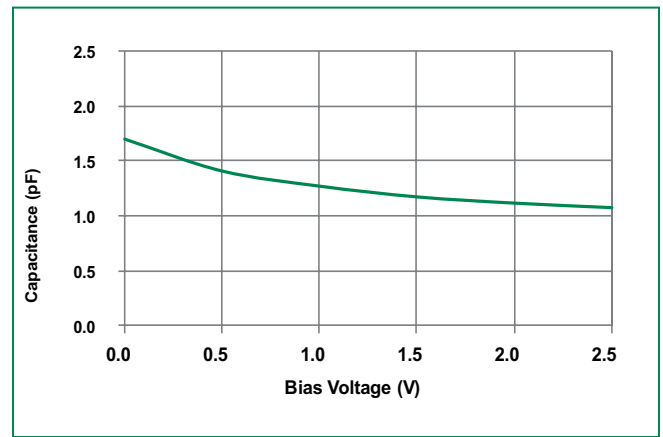

Positive Transmission Line Pulsing (TLP) Plot

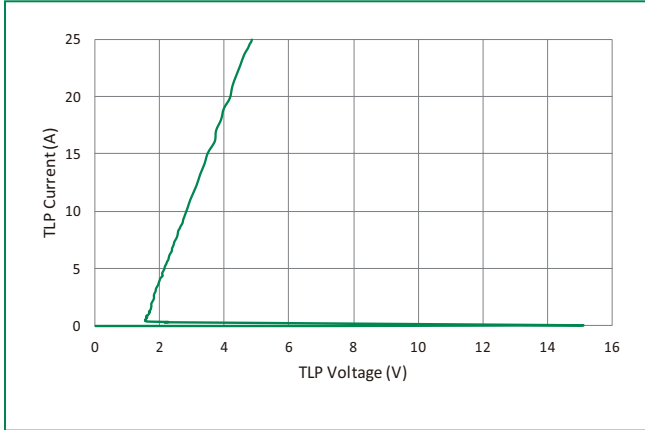

Negative Transmission Line Pulsing (TLP) Plot

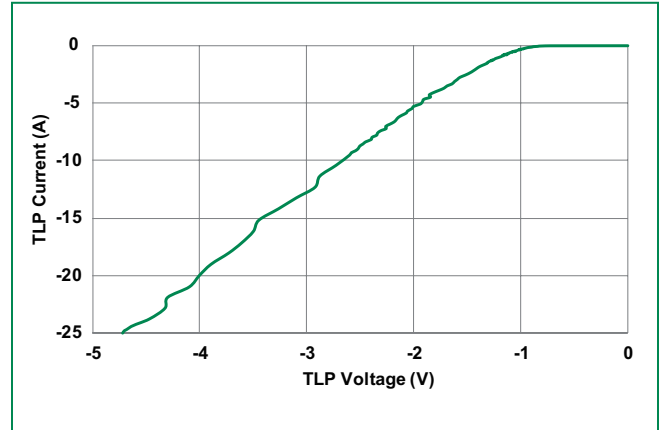

Clamping Voltage vs. Peak Pulse Current

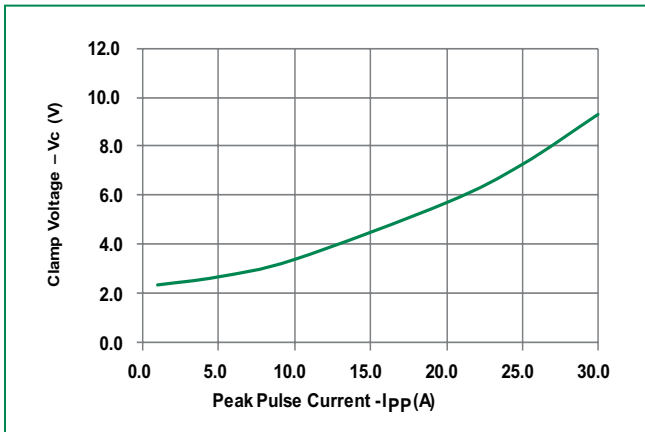

IEC 61000-4-2 +8 kV Contact ESD Clamping Voltage

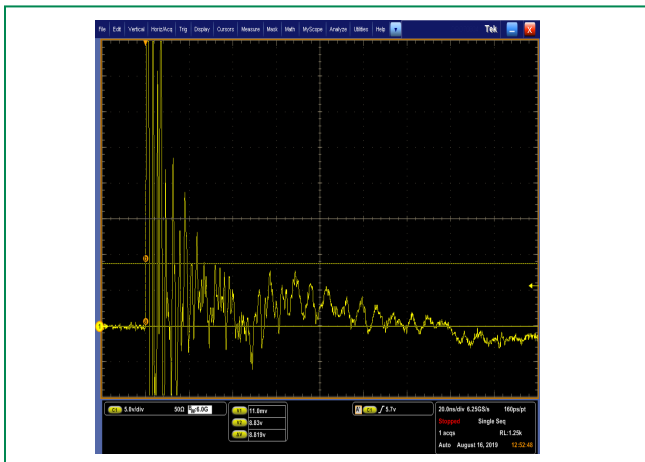

IEC 61000-4-2 -8 kV Contact ESD Clamping Voltage

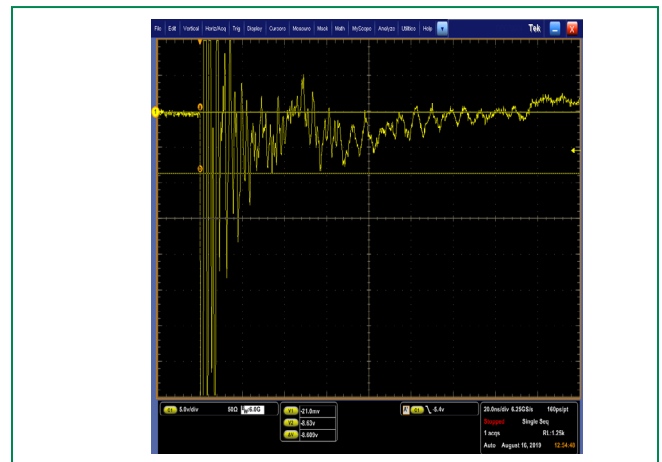

Soldering Parameters

Reflow Condition		Pb – Free assembly
Pre Heat	- Temperature Min ($T_{s(min)}$)	150°C
	- Temperature Max ($T_{s(max)}$)	200°C
	- Time (min to max) (t_s)	60 – 180 secs
Average ramp up rate (Liquidus) Temp (T_L) to peak		3°C/second max
$T_{s(max)}$ to T_L - Ramp-up Rate		3°C/second max
Reflow	- Temperature (T_L) (Liquidus)	217°C
	- Temperature (t_L)	60 – 150 seconds
Peak Temperature (T_p)		260 ^{+0/-5} °C
Time within 5°C of actual peak Temperature (t_p)		20 – 40 seconds
Ramp-down Rate		6°C/second max
Time 25°C to peak Temperature (T_p)		8 minutes Max.
Do not exceed		260°C

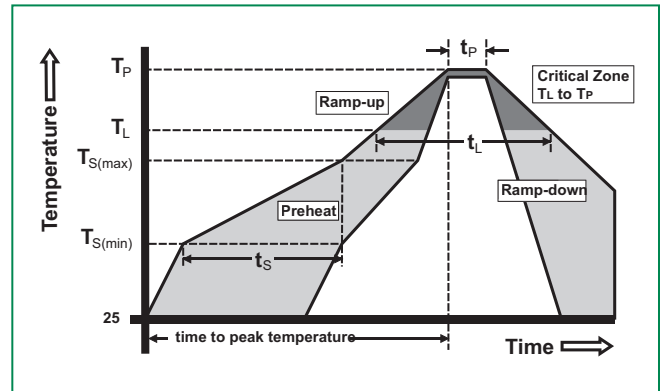

Ordering Information

Part Number	Package	Min. Order Qty.
SP2525NUTG	μDFN-10 (3.0x2.0mm)	3000

Product Characteristics

Lead Plating	PPF
Lead Material	Copper Alloy
Substrate Material	Silicon
Body Material	Molded Compound
Flammability	UL Recognized compound meeting flammability rating V-0

Part Marking System



First row = Part name = SP2525NUTG
 Second row = Assembly code + Date Code

Part Numbering System

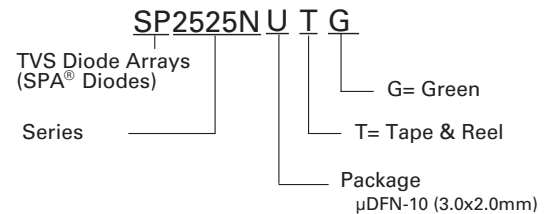

Package Dimensions - μ DFN-10 (3.0x2.0mm)

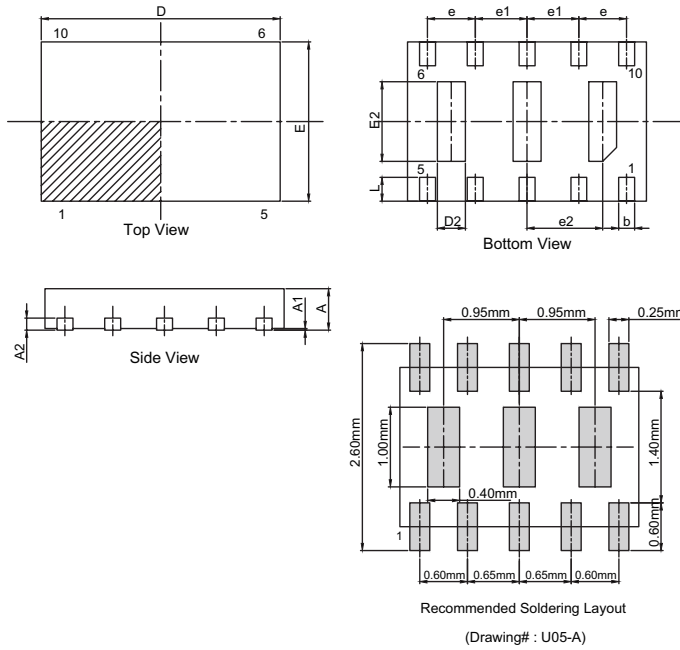

Symbol	Millimeters			Inches		
	Min	Nom	Max	Min	Nom	Max
A	0.50	0.55	0.60	0.020	0.022	0.024
A1	0.00	0.02	0.05	0.000	0.001	0.002
A2	0.15 Ref			0.006 Ref		
b	0.15	0.20	0.25	0.006	0.008	0.010
D	2.90	3.00	3.10	0.114	0.118	0.122
E	1.90	2.00	2.10	0.075	0.079	0.083
D2	0.25	0.35	0.45	0.010	0.014	0.018
E2	0.90	1.00	1.10	0.035	0.039	0.043
L	0.20	0.30	0.40	0.008	0.012	0.016
e	0.60 BSC			0.024 BSC		
e1	0.65 BSC			0.026 BSC		
e2	0.95 BSC			0.037 BSC		

Tape & Reel Specification — μ DFN-10 (3.0x2.0mm)

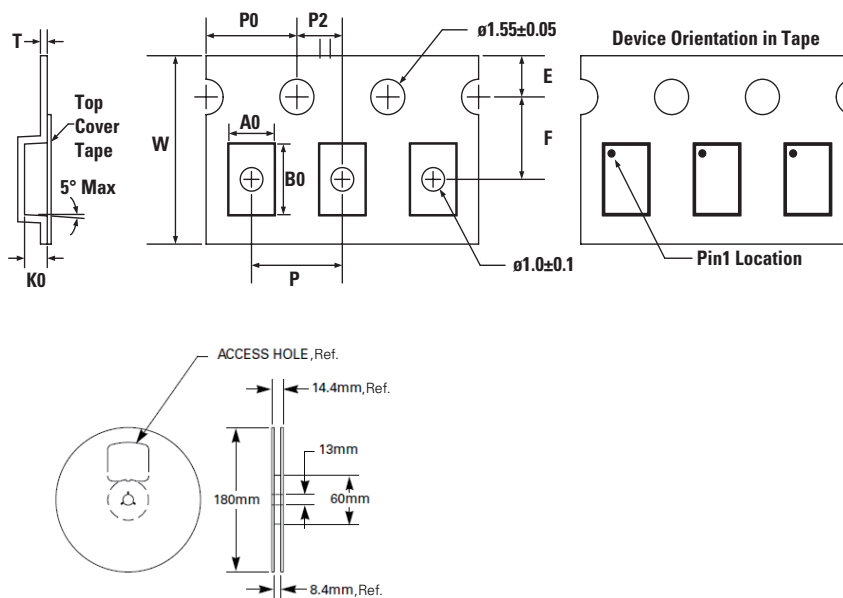

Package	μ DFN-10 (3.0x2.0mm)
Symbol	Millimeters
A0	2.30 +/- 0.10
B0	3.20 +/- 0.10
E	1.75 +/- 0.10
F	3.50 +/- 0.05
K0	1.0 +/- 0.10
P	4.00 +/- 0.10
P0	4.00 +/- 0.10
P2	2.00 +/- 0.10
T	0.3 +/- 0.05
W	8.00 +0.30/- 0.10

8mm TAPE AND REEL

Disclaimer Notice - Information furnished is believed to be accurate and reliable. However, users should independently evaluate the suitability of and test each product selected for their own applications. Littelfuse products are not designed for, and may not be used in, all applications. Read complete Disclaimer Notice at <http://www.littelfuse.com/disclaimer-electronics>.