

Pxxx0SxL-A Series

Baseband Protection (Voice-DS1) - DO-214AA



Description

Pxxx0SxL-A series is designed to protect automotive grade equipments such as vehicle infotainment system, device communication line and automotive camera data lines from damaging overvoltage transients.

The series provides a surface mount solution that enables equipments to comply with global regulatory standards.

Features and Benefits

- Automotive grade AEC-Q101 Qualified
- Low voltage overshoot
- Low on-state voltage
- Does not degrade surge capability after multiple surge events within limit.
- Fails short circuit when surged in excess of currents
- Low capacitance
- Pb-free E3 means 2nd level interconnect is Pb-free and the terminal finish material is tin(Sn) (IPC/JEDEC J-STD-609A.01)
- UL Recognized to UL 497B as an Isolated Loop Circuit Protector.

Additional Information



Resources



Accessories



Samples

Agency Approvals

Agency	Agency File Number
	E133083

Schematic Symbol

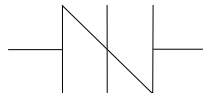

Electrical Characteristics

Part Number	Marking	V_{DRM} @ $I_{DRM}=5\mu A$	V_S @ 100V/ μs	I_H	I_S	I_T	V_T @ $I_T=2.2$ Amps	Capacitance @ 1MHz, 2V bias	
		V min	V max	mA min	mA max	A max	V max	pF min	pF max
P0080SALRP-A	A-8A	6	25	50	800	2.2	4	20	35
P0220SALRP-A	A22A	15	32	50	800	2.2	4	20	40
P0300SALRP-A	A03A	25	47	50	800	2.2	4	15	40
P0640SALRP-A	A06A	58	77	150	800	2.2	4	15	40
P0720SALRP-A	A07A	65	88	150	800	2.2	4	15	40
P0900SALRP-A	A09A	75	98	150	800	2.2	4	15	40
P1100SALRP-A	A11A	90	130	150	800	2.2	4	15	40
P1300SALRP-A	A13A	120	160	150	800	2.2	4	15	40
P1500SALRP-A	A15A	140	180	150	800	2.2	4	15	40
P1800SALRP-A	A18A	170	220	150	800	2.2	4	15	35
P1800SCLRP-A	A18C	170	220	150	800	2.2	4	25	70
P2100SALRP-A	A21A	180	240	150	800	2.2	4	15	35
P2300SALRP-A	A23A	190	260	150	800	2.2	4	15	35
P2600SALRP-A	A26A	220	300	150	800	2.2	4	15	35
P3100SALRP-A	A31A	275	350	150	800	2.2	4	15	35

Pxxx0SxL-A Series

Baseband Protection (Voice-DS1) - DO-214AA

Surge Ratings

Series	I_{PP}									I_{TSM} 50/60 Hz	di/dt
	0.2/310 ¹ 0.5/700 ²	2/10 ¹ 2/10 ²	8/20 ¹ 1.2/50 ²	10/160 ¹ 10/160 ²	10/560 ¹ 10/560 ²	5/320 ¹ 9/720 ²	10/360 ¹ 10/360 ²	10/1000 ¹ 10/1000 ²	5/310 ¹ 10/700 ²		
	A min	A min	A min	A min	A min	A min	A min	A min	A min		
A	20	150	150	90	50	75	75	45	75	25	500
C	50	500	400	200	150	200	175	100	200	35	500

Notes:

1. Current waveform in μs
2. Voltage waveform in μs

- Peak pulse current rating (I_{pp}) is repetitive and guaranteed for the life of the product.
 - 1ms non-repetitive square pulse at $T_A=85^\circ C$ minimum surge current is 18A

Thermal Considerations

Package	Symbol	Parameter	Value	Unit
DO-214AA 	T_J	Operating Junction Temperature Range	-55 to +150	$^\circ C$
	T_S	Storage Temperature Range	-65 to +150	$^\circ C$
	$R_{\theta JA}$	Thermal Resistance: Junction to Ambient	90	$^\circ C/W$

V-I Characteristics

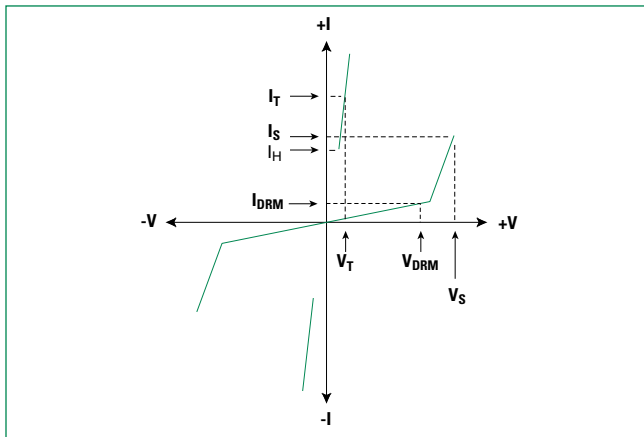

tr x td Pulse Waveform

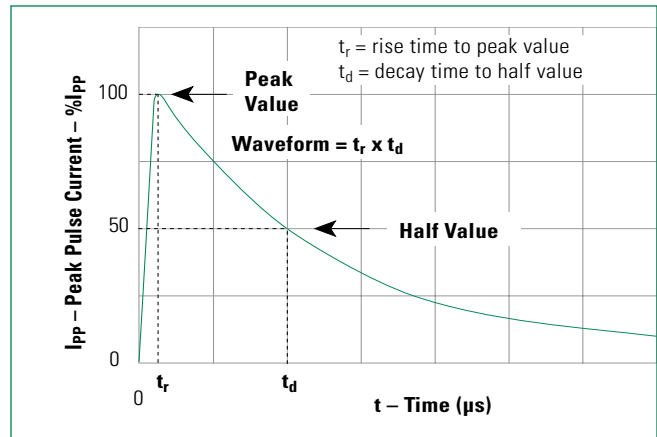

Normalized VS Change vs. Junction Temperature

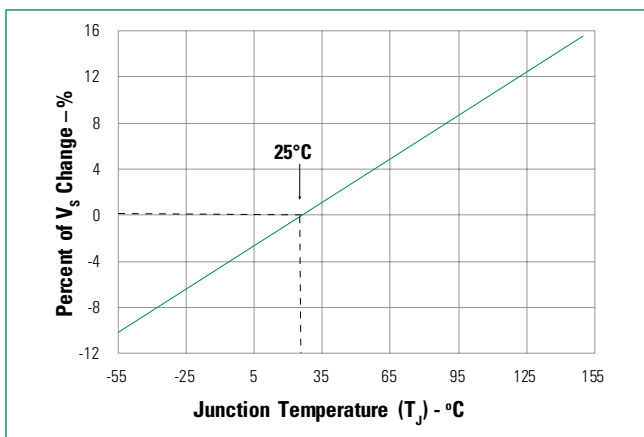

Normalized DC Holding Current vs. Case Temperature

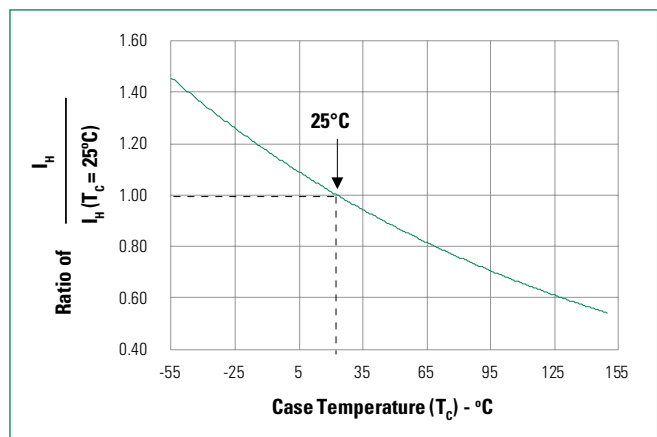

Pxxx0SxL-A Series

Baseband Protection (Voice-DS1) - DO-214AA

Soldering Parameters

Reflow Condition		Pb-Free assembly (see Fig. 1)
Pre Heat	- Temperature Min ($T_{s(min)}$)	+150°C
	- Temperature Max ($T_{s(max)}$)	+200°C
	- Time (Min to Max) (t_s)	60-180 secs.
Average ramp up rate (Liquidus Temp (T_L) to peak)		3°C/sec. Max.
$T_{s(max)}$ to T_L - Ramp-up Rate		3°C/sec. Max.
Reflow	- Temperature (T_L) (Liquidus)	+217°C
	- Temperature (t_L)	60-150 secs.
Peak Temp (T_p)		+260(+0/-5)°C
Time within 5°C of actual Peak Temp (t_p)		30 secs. Max.
Ramp-down Rate		6°C/sec. Max.
Time 25°C to Peak Temp (T_p)		8 min. Max.
Do not exceed		+260°C

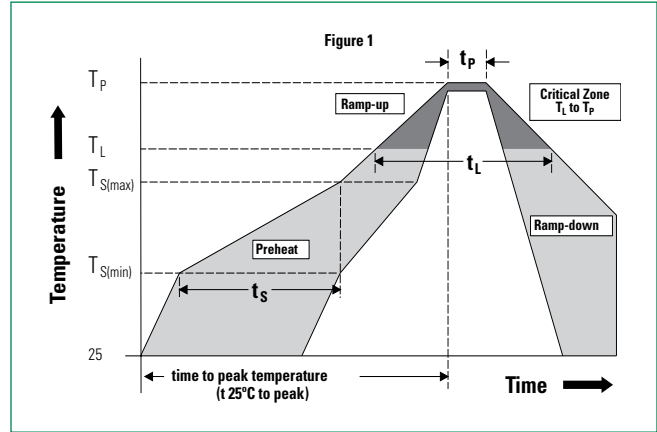

Physical Specifications

Lead Material	Copper Alloy
Terminal Finish	100% Matte-Tin Plated
Body Material	UL Recognized compound meeting flammability rating V-0

Environmental Specifications

High Temp Voltage Blocking	80% Rated VDRM (VAC Peak) +150 °C, 504 or 1008 hrs. MIL-STD-750 (Method 1040) JEDEC, JESD22-A-101
Temp Cycling	-65 °C to +150 °C, 15 min. dwell, 10 up to 100 cycles. MIL-STD-750 (Method 1051) EIA/JEDEC, JESD22-A104
Biased Temp & Humidity	80% rated VDRM (+85 °C) 85%RH, and not exceed 100 V or limit of chamber. 504 up to 1008 hrs. EIA/JEDEC, JESD22-A-101
High Temp Storage	+150 °C 1008 hrs. MIL-STD-750 (Method 1031) JEDEC, JESD22-A-101
Low Temp Storage	-65 °C, 1008 hrs.
Thermal Shock	0 °C to +100 °C, 5 min. dwell, 10 sec. transfer, 10 cycles. MIL-STD-750 (Method 1056) JEDEC, JESD22-A-106
Autoclave (Pressure Cooker Test)	+121 °C, 100% RH, 2atm, 24 up to 168 hrs. EIA/JEDEC, JESD22-A-102
Resistance to Solder Heat	+260 °C, 30 secs. MIL-STD-750 (Method 2031)
Moisture Sensitivity Level	85%RH, +85 °C, 168 hrs., 3 reflow cycles (+260 °C Peak). JEDEC-J-STD-020, Level 1

Part Numbering

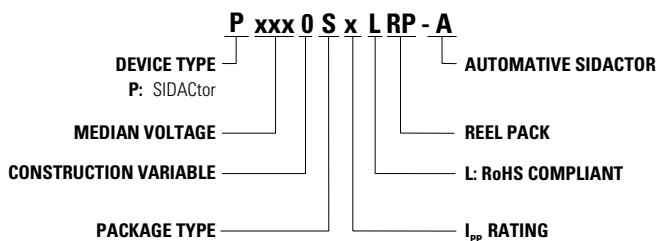

Part Marking

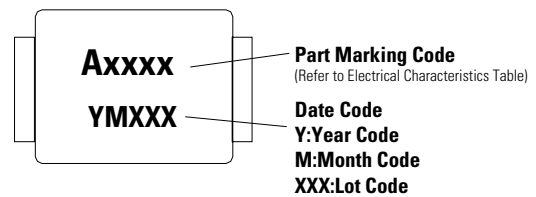

Pxxx0SxL-A Series

Baseband Protection (Voice-DS1) - DO-214AA

Dimensions – DO-214AA

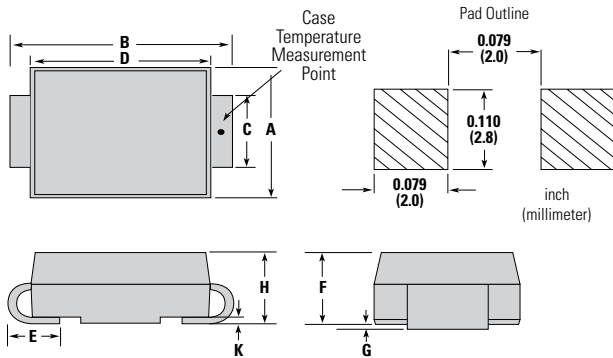

Dimensions	Inches		Millimeters	
	Min	Max	Min	Max
A	0.130	0.156	3.30	3.95
B	0.201	0.220	5.10	5.60
C	0.077	0.087	1.95	2.20
D	0.159	0.181	4.05	4.60
E	0.030	0.063	0.75	1.60
F	0.075	0.096	1.90	2.45
G	0.002	0.008	0.05	0.20
H	0.077	0.104	1.95	2.65
K	0.006	0.016	0.15	0.41

Packing Options

Package Type	Description	Quantity	Added Suffix	Industry Standard
S	DO-214AA Tape & Reel Pack	2500	RP	EIA-481-D

Tape and Reel Specification – DO-214AA

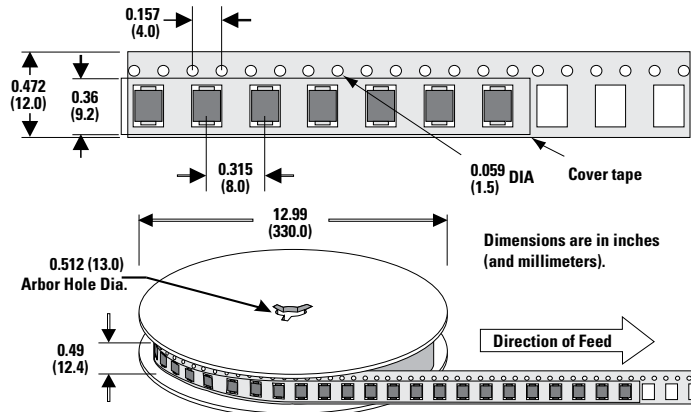

Disclaimer Notice - Information furnished is believed to be accurate and reliable. However, users should independently evaluate the suitability of and test each product selected for their own applications. Littelfuse products are not designed for, and may not be used in, all applications. Read complete Disclaimer Notice at <http://www.littelfuse.com/disclaimer-electronics>.