

MAC8DG, MAC8MG, MAC8NG

Surface Mount – 400V -800V



Description

Designed for high performance full-wave ac control applications where high noise immunity and high commutating di/dt are required. The MAC8xG series is designed for high performance full-wave AC control applications where high noise immunity and high commutating di/dt are required.

Features

- Blocking Voltage to 800 Volts
- On-State Current Rating of 8.0 Amperes RMS at 100°C
- Uniform Gate Trigger Currents in Three Quadrants
- High Immunity to dv/dt – 250 V/μs minimum at 125°C
- Minimizes Snubber Networks for Protection
- Industry Standard TO-220 Package
- High Commutating di/dt – 6.5 A/ms minimum at 125°C
- These Devices are Pb-Free and are RoHS Compliant

Additional Information



Resources



Accessories



Samples

Functional Diagram

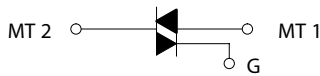

Pin Out

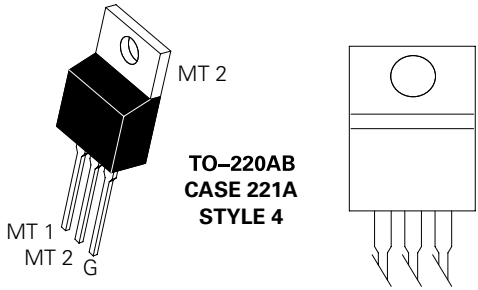

MAC8DG, MAC8MG, MAC8NG

Surface Mount – 400V -800V

Maximum Ratings ($T_J = 25^\circ\text{C}$ unless otherwise noted)

Rating		Symbol	Value	Unit
Peak Repetitive Off-State Voltage (Note 1) (Gate Open, Sine Wave 50 to 60 Hz, $T_J = -40^\circ$ to 125°C)	MAC8DG	V_{DRM} V_{RRM}	400	V
	MAC8MG		600	
	MAC8NG		800	
On-State RMS Current (Full Cycle Sine Wave, 60 Hz, $T_C = 100^\circ\text{C}$)		$I_T (RMS)$	8.0	A
Peak Non-Repetitive Surge Current (One Full Cycle Sine Wave, 60 Hz, $T_C = 125^\circ\text{C}$)		I_{TSM}	80	A
Circuit Fusing Consideration ($t = 8.3$ ms)		I^2t	26	A ² sec
Peak Gate Power (Pulse Width ≤ 1.0 μs , $T_C = 80^\circ\text{C}$)		P_{GM}	16	W
Average Gate Power ($t = 8.3$ ms, $T_J = 80^\circ\text{C}$)		$P_{G(AV)}$	0.35	W
Operating Junction Temperature Range		T_J	-40 to +125	$^\circ\text{C}$
Storage Temperature Range		T_{stg}	-40 to +150	$^\circ\text{C}$

Stresses exceeding Maximum Ratings may damage the device. Maximum Ratings are stress ratings only. Functional operation above the Recommended Operating Conditions is not implied. Extended exposure to stresses above the Recommended Operating Conditions may affect device reliability.

1. V_{DRM} and V_{RRM} for all types can be applied on a continuous basis. Ratings apply for zero or negative gate voltage; however, positive gate voltage shall not be applied concurrent with negative potential on the anode. Blocking voltages shall not be tested with a constant current source such that the voltage ratings of the devices are exceeded.

Thermal Characteristics

Rating		Symbol	Value	Unit
Thermal Resistance,	Junction-to-Case (AC)	$R_{\theta JC}$	2.2	$^\circ\text{C}/\text{W}$
	Junction-to-Ambient	$R_{\theta JA}$	62.5	
Maximum Lead Temperature for Soldering Purposes, 1/8" from case for 10 seconds		T_L	260	$^\circ\text{C}$

Electrical Characteristics - OFF ($T_J = 25^\circ\text{C}$ unless otherwise noted ; Electricals apply in both directions)

Characteristic		Symbol	Min	Typ	Max	Unit
Peak Repetitive Blocking Current ($V_D = V_{DRM} = V_{RRM}$; Gate Open)	$T_J = 25^\circ\text{C}$	I_{DRM} I_{RRM}	-	-	0.01	mA
	$T_J = 125^\circ\text{C}$		-	-	2.0	

Electrical Characteristics - ON ($T_J = 25^\circ\text{C}$ unless otherwise noted; Electricals apply in both directions)

Characteristic		Symbol	Min	Typ	Max	Unit
Peak On-State Voltage (Note 4) ($I_{TM} = \pm 6.0$ A)		V_{TM}	-	1.3	1.6	V
Gate Trigger Current (Continuous dc) ($V_D = 12$ V, $R_L = 100$ Ω)	MT2(+), G(+)	I_{GT}	5.0	13	35.0	mA
	MT2(+), G(-)		5.0	16	35.0	
	MT2(-), G(-)		5.0	18	35.0	
Holding Current ($V_D = 12$ V, Gate Open, Initiating Current = ± 150 mA)		I_H	-	20	40	mA
Latching Current ($V_D = 24$ V, $I_G = 35$ mA)	MT2(+), G(+)	I_L	-	20	50	mA
	MT2(+), G(-)		-	30	80	
	MT2(-), G(-)		-	20	50	
Gate Trigger Voltage ($V_D = 12$ V, $R_L = 100$ Ω)	MT2(+), G(+)	V_{GT}	0.5	0.69	1.5	V
	MT2(+), G(-)		0.5	0.77	1.5	
	MT2(-), G(-)		0.5	0.72	1.5	
Gate Non-Trigger Voltage ($T_J = 125^\circ\text{C}$) ($V_D = 12$ V, $R_L = 100$ Ω)	MT2(+), G(+)	V_{GD}	0.2	-	-	V
	MT2(+), G(-)		0.2	-	-	
	MT2(-), G(-)		0.2	-	-	

2. Indicates Pulse Test: Pulse Width ≤ 2.0 ms, Duty Cycle $\leq 2\%$.

MAC8DG, MAC8MG, MAC8NG

Surface Mount – 400V -800V

Dynamic Characteristics

Characteristic	Symbol	Min	Typ	Max	Unit
Rate of Change of Commutating Current See Figure 10. ($V_D = 400V$, $I_{TM} = 4.4A$, Commutating $dv/dt = 18V/\mu s$, Gate Open, $T_J = 125^\circ C$, $f = 250Hz$, No Snubber) $C_L = 10\mu F$ $L_L = 40mH$	$(dv/dt)_c$	6.5	–	–	A/ms
Critical Rate of Rise of Off-State Voltage ($V_D = \text{Rated } V_{DRM}$, Exponential Waveform, Gate Open, $T_J = 125^\circ C$)	dV/dt	250	–	–	V/ μs

Voltage Current Characteristic of SCR

Symbol	Parameter
V_{DRM}	Peak Repetitive Forward Off State Voltage
I_{DRM}	Peak Forward Blocking Current
V_{RRM}	Peak Repetitive Reverse Off State Voltage
I_{RRM}	Peak Reverse Blocking Current
V_{TM}	Maximum On State Voltage
I_H	Holding Current

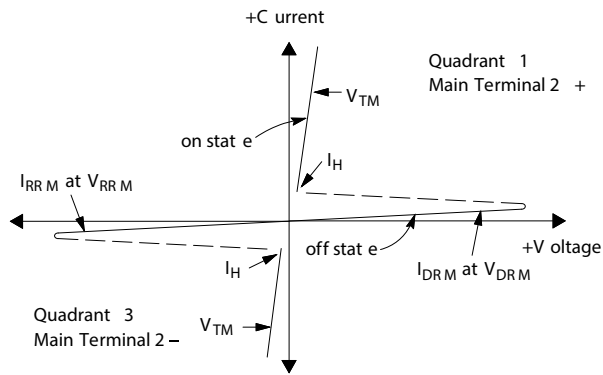

Quadrant Definitions for a Triac

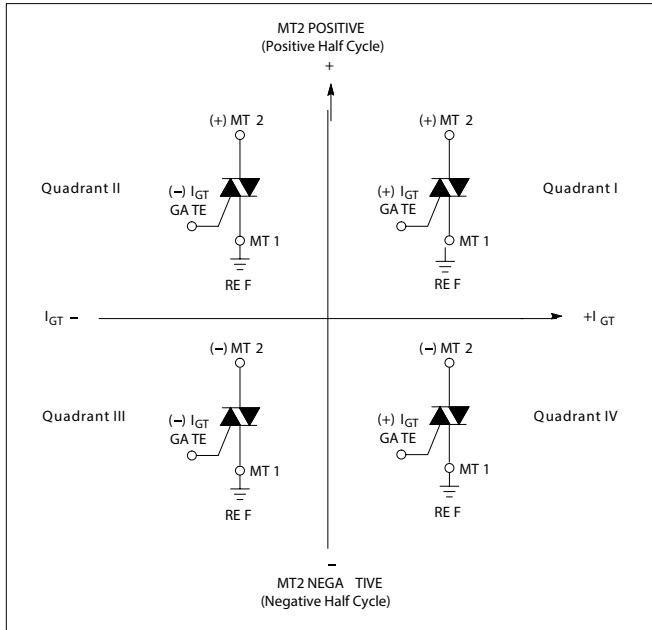

All polarities are referenced to MT1.
With in-phase signals (using standard AC lines) quadrants I and III are used

MAC8DG, MAC8MG, MAC8NG

Surface Mount – 400V -800V

Figure 1. RMS Current Derating

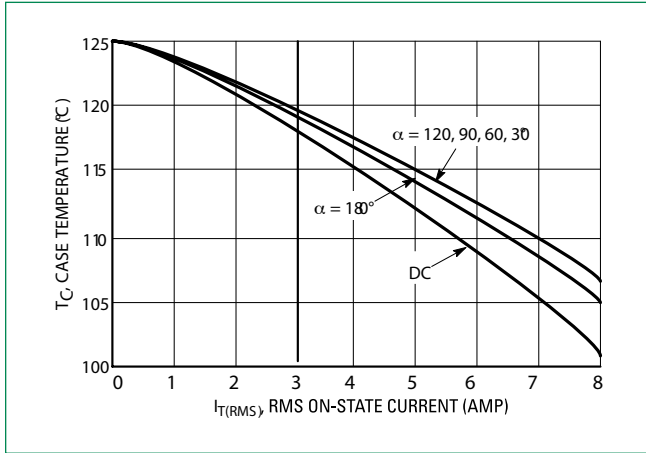

Figure 2. On-State Power Dissipation

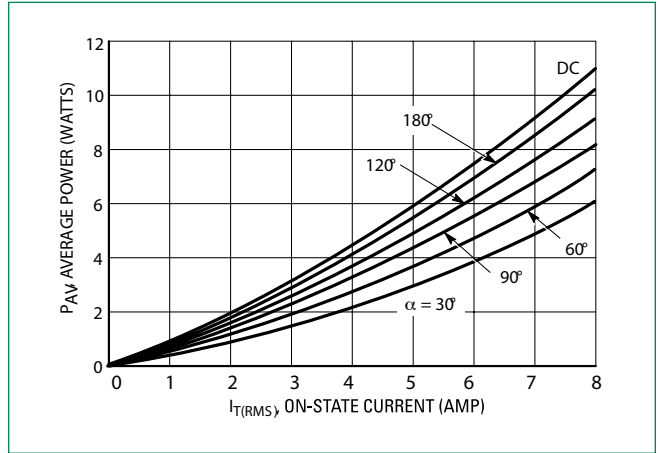

Figure 3. On-State Characteristics

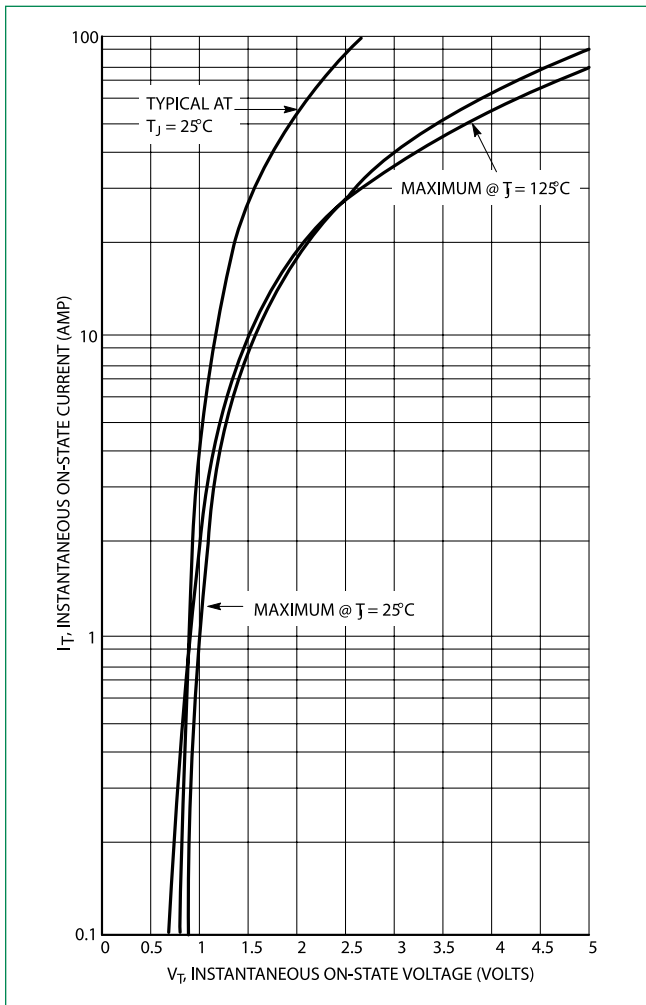

Figure 4. Thermal Response

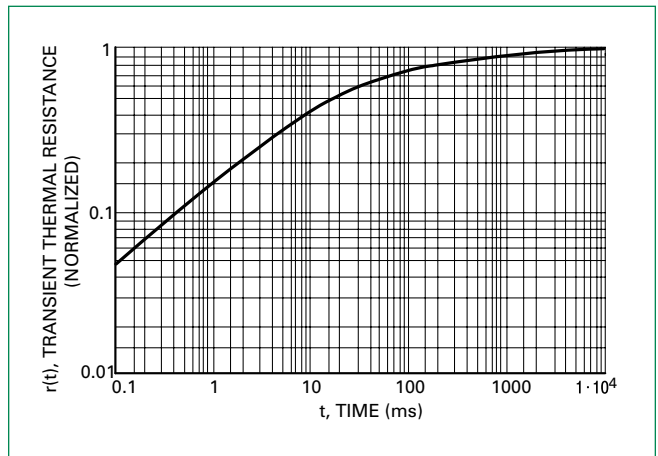
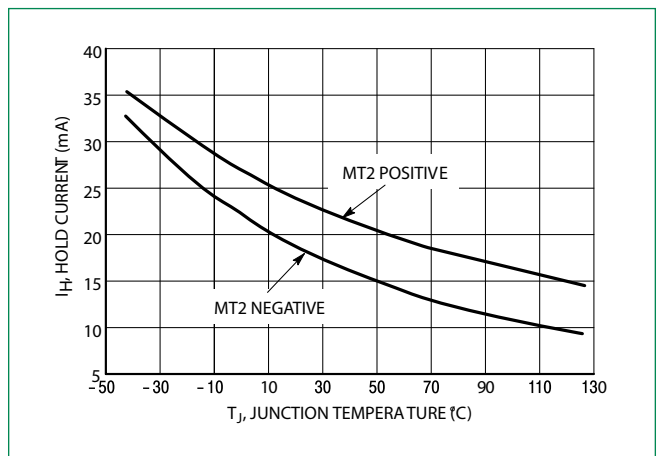

Figure 5. Hold Current Variation



MAC8DG, MAC8MG, MAC8NG

Surface Mount – 400V -800V

Figure 6. Gate Trigger Current Variation

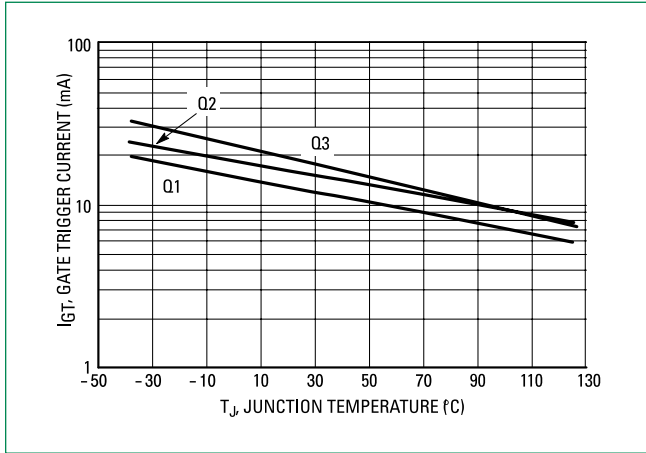

Figure 7. Gate Trigger Voltage Variation

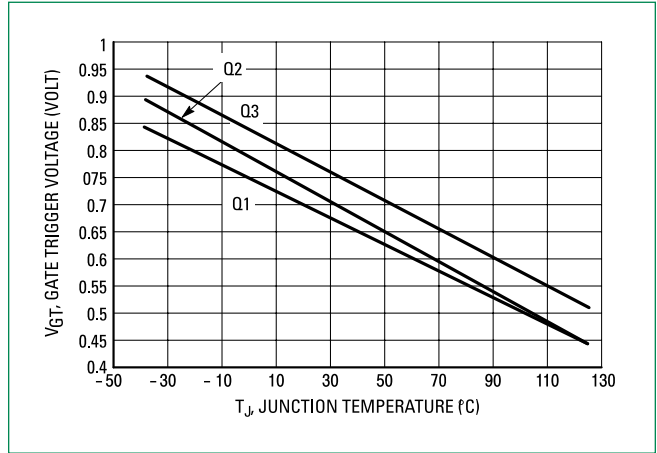

Figure 8. Critical Rate of Rise of Off-State Voltage (Exponential)

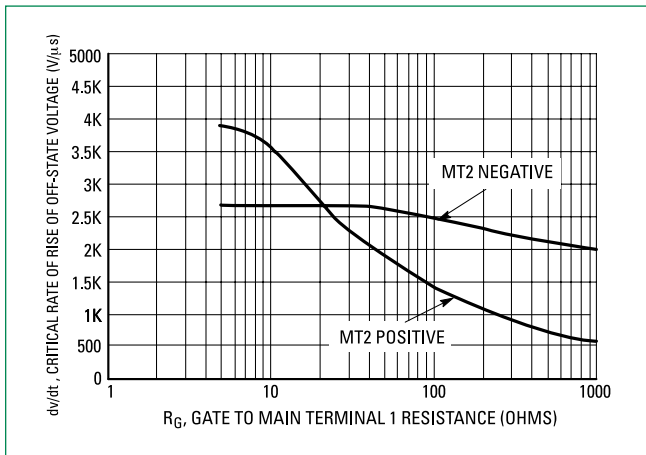

Figure 9. Critical Rate of Rise of Commutating Voltage

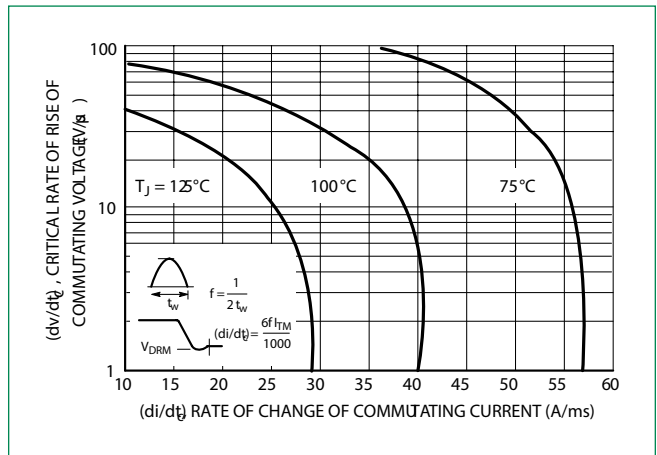
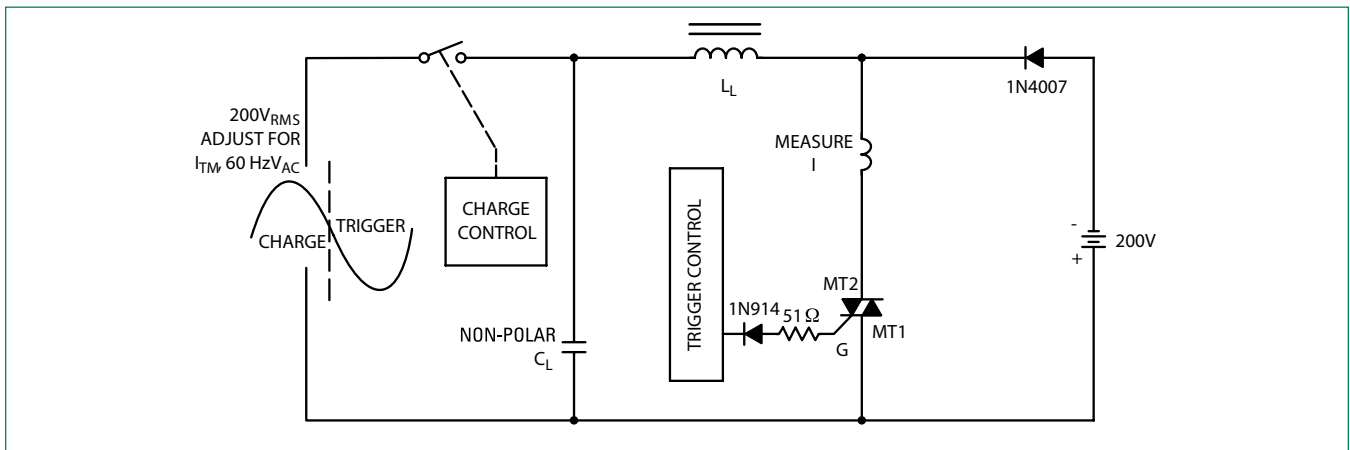

Figure 10. Simplified Test Circuit to Measure the Critical Rate of Rise of Commutating Current (di/dt)



Note: Component values are for verification of rated (di/dt) . See AN1048 for additional information

MAC8DG, MAC8MG, MAC8NG

Surface Mount – 400V -800V

Dimensions

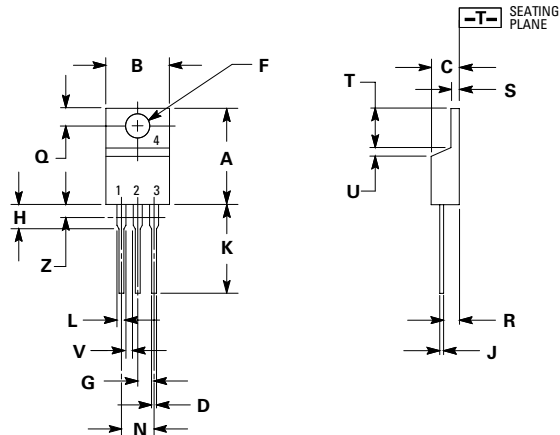

Dim	Inches		Millimeters	
	Min	Max	Min	Max
A	0.590	0.620	14.99	15.75
B	0.380	0.420	9.65	10.67
C	0.178	0.188	4.52	4.78
D	0.025	0.035	0.64	0.89
F	0.142	0.147	3.61	3.73
G	0.095	0.105	2.41	2.67
H	0.110	0.130	2.79	3.30
J	0.018	0.024	0.46	0.61
K	0.540	0.575	13.72	14.61
L	0.060	0.075	1.52	1.91
N	0.195	0.205	4.95	5.21
Q	0.105	0.115	2.67	2.92
R	0.085	0.095	2.16	2.41
S	0.045	0.060	1.14	1.52
T	0.235	0.255	5.97	6.47
U	0.000	0.050	0.00	1.27
V	0.045	---	1.15	---
Z	---	0.080	---	2.04

1. Dimensioning and tolerancing per ansi y14.5m, 1982.
2. Controlling dimension: inch.
3. Dimension z defines a zone where all body and lead irregularities are allowed.

Part Marking System

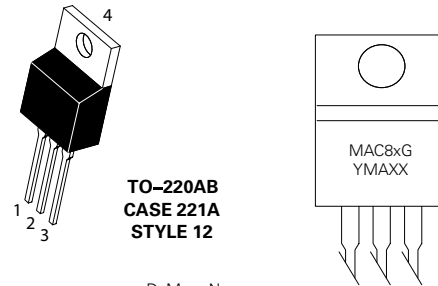

**TO-220AB
CASE 221A
STYLE 12**

x =D, M, or N
Y =Year
M =Month
A =Assembly Site
XX =Lot Serial Code
G =Pb-Free Package

Pin Assignment	
1	Main Terminal 1
2	Main Terminal 2
3	Gate
4	Main Terminal 2

Ordering Information

Device	Package	Shipping
MAC8DG	TO-220AB (Pb-Free)	1000 Units / Box
MAC8MG		
MAC8NG		

Disclaimer Notice - Information furnished is believed to be accurate and reliable. However, users should independently evaluate the suitability of and test each product selected for their own applications. Littelfuse products are not designed for, and may not be used in, all applications. Read complete Disclaimer Notice at <http://www.littelfuse.com/disclaimer-electronics>.