

QJxx30xHx & QJxx35xHx series

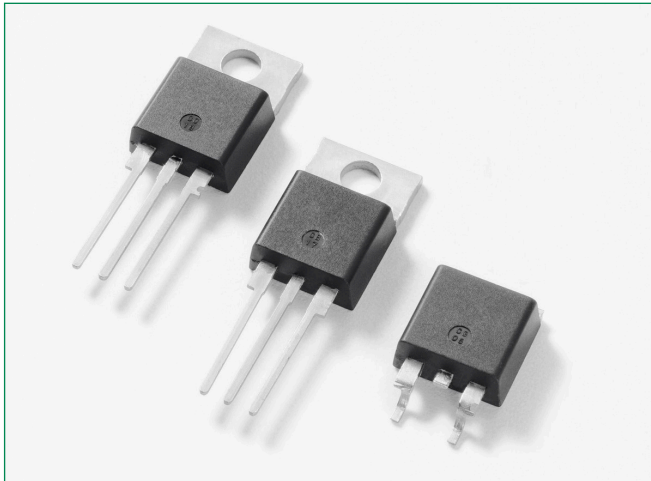

Description

This 30 A/35 A high temperature Alternistor TRIAC has 150°C maximum junction temperature and 350 A I_{TSM} (60 Hz). This series enables easier thermal management and higher surge handling capability in AC power control applications such as heater control, motor speed control, lighting controls, and static switching relays. Alternistor TRIAC operates in Quadrants I, II, and III and offers high performance in applications requiring high commutation capability.

Features

- Voltage capability up to 800 V
- Mechanically and thermally robust TO-220 clip-attach assembly
- Surge capability of 350 A at 60 Hz half cycle
- High T_{VJ} of 150°C
- L package UL recognized under E71639 for Electrical isolated at 2500 V_{RMS}
- Halogen free and RoHS compliant

Pinout Diagram

TO-220AB (L-Package)

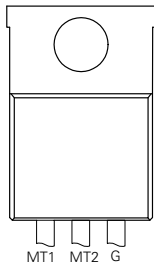

TO-220AB (R-Package)

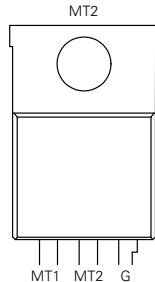

TO-263AB

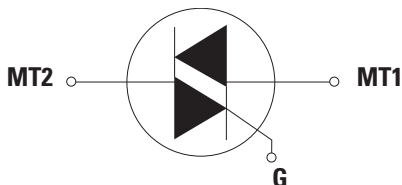
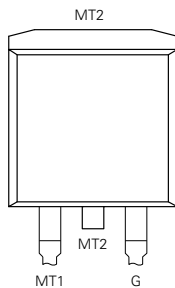

MT1: Main Terminal 1; **MT2:** Main Terminal 2; **G:** Gate

Applications

TRIAC is an excellent AC switch in applications such as heating, lighting, and motor speed controls.

Typical applications include:

- Heater control such as coffee brewer, tankless water heater and infrared heater
- AC solid-state relays
- Light dimmers including incandescent and LED lighting
- Motor speed control in kitchen appliances, power tools, home/brow/white goods and light industrial applications as compressor motor control

Alternistor TRIAC is used with high inductive loads requiring high commutation capability. Internally isolated packages offer better heat sinking with higher isolation voltage.

Product Summary

Symbol	Value	Unit
$I_{T(RMS)}$	30 or 35	A
V_{DRM}/V_{RRM}	600 or 800	V
$I_{GT(Q1)}$	35 or 50	mA

Absolute Maximum Ratings — Alternistor TRIAC (3 Quadrants)

Symbol	Parameter		Value	Unit	
V_{DSM}/V_{RSM}	Peak non-repetitive blocking voltage		$V_{DRM} + 200\text{ V}$	V	
$I_{T(RMS)}$	RMS on-state current (full sine wave)	QJxx30LHx	$T_C = 90^\circ\text{C}$	30	A
		QJxx30RHx/QJxx30NHx	$T_C = 115^\circ\text{C}$		
		QJxx35LHx	$T_C = 80^\circ\text{C}$	35	A
		QJxx35RHx/QJxx35NHx	$T_C = 110^\circ\text{C}$		
I_{TSM}	Non repetitive surge peak on-state current (Full cycle, T_{VJ} initial = 25°C)	f = 50 Hz	t = 20 ms	290	A
		f = 60 Hz	t = 16.7 ms	350	
I^2t	I^2t Value for fusing		$t_p = 8.3\text{ ms}$	508	A^2s
di/dt	Critical rate of rise of on-state current	f = 60 Hz	$T_{VJ} = 150^\circ\text{C}$	100	$\text{A}/\mu\text{s}$
I_{GTM}	Peak gate trigger current	$t_p \leq 20\ \mu\text{s};$ $I_{GT} \leq I_{GTM}$	$T_{VJ} = 150^\circ\text{C}$	4.0	A
$P_{G(AV)}$	Average gate power dissipation		$T_{VJ} = 150^\circ\text{C}$	1.0	W
T_{stg}	Storage temperature range			-40 to 150	$^\circ\text{C}$
T_{VJ}	Operating junction temperature range			-40 to 150	$^\circ\text{C}$

y = sensitivity

Electrical Characteristics ($T_{VJ} = 25^\circ\text{C}$, unless otherwise specified) — Alternistor TRIAC (3 Quadrants)

Symbol	Parameter	Test Conditions	Quadrant	Value		Unit	
				QJxx30xH4/ QJxx35xH4	QJxx30xH5/ QJxx35xH5		
I_{GT}	Trigger Gate Current	$V_D = 12\text{ V}; R_L = 60\ \Omega$	I – II – III	MAX.	35	50	mA
V_{GT}	Trigger Gate Voltage		I – II – III	MAX.	1.0	1.3	V
V_{GD}	Non-trigger Gate Voltage	$V_D = V_{DRM}; R_L = 3.3\ \text{k}\Omega; T_{VJ} = 150^\circ\text{C}$	I – II – III	MIN.	0.2	0.2	V
I_H	Holding Current	$I_T = 100\text{ mA}$		MAX.	60	75	mA
dv/dt	Rate of Rise of Voltage	$V_D = 2/3 V_{DRM};$ Gate Open; $T_{VJ} = 150^\circ\text{C};$ $V_{DRM} = 800\text{ V}$		MIN.	900	1000	$\text{V}/\mu\text{s}$
(dv/dt) _c	Critical Rate of Rise of Voltage	(di/dt) _c = 9 A/ms $T_{VJ} = 150^\circ\text{C}$		MIN.	20	20	$\text{V}/\mu\text{s}$
t_{gt}	Turn-on Time	30 A device	I _G = 2 × I _{GT} ; P _W = 15 μs; I _T = 42.4 A(pk)	TYP.	3	3	μs
		35 A device					

Static Characteristics

Symbol	Test Conditions		Value	Unit		
V_{TM}	30 A device	$I_T = 42.4\text{ A}; t_p = 380\ \mu\text{s}$	MAX	1.5		
	35 A device	$I_T = 49.5\text{ A}; t_p = 380\ \mu\text{s}$		1.55		
I_{DRM} / I_{RRM}	$V_D = V_{DRM} / V_{RRM}$		MAX	$T_{VJ} = 25^\circ\text{C}$	5	μA
				$T_{VJ} = 150^\circ\text{C}$	3	mA

Thermal Resistances

Symbol	Parameter		Value	Unit
R_{thJC}	Junction to case (AC)	QJxx30LHx/QJxx35LHx	1.8	K/W
		QJxx30RHx/QJxx30NHx	1.0	
		QJxx35RHx/QJxx35NHx		

Figure 1: Definition of Quadrants

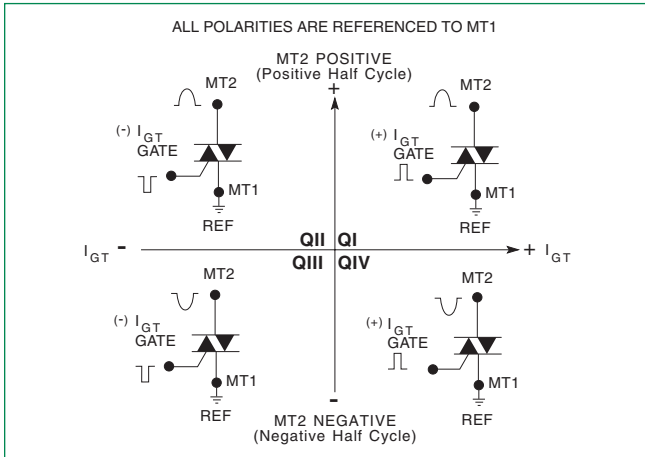

Note: Alternistors will not operate in QIV

Figure 2: Normalized DC Gate Trigger Current for All Quadrants vs. Junction Temperature

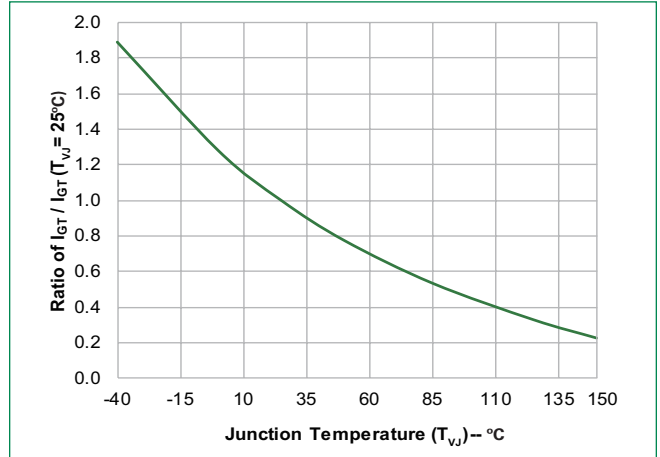

Figure 3: Normalized DC Holding Current vs. Junction Temperature

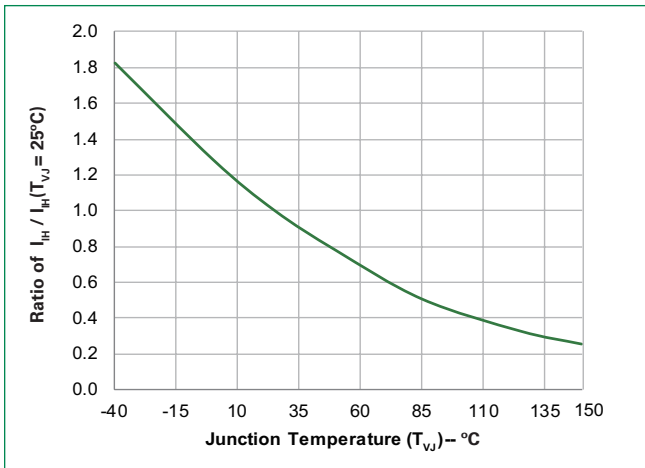

Figure 4: Normalized DC Gate Trigger Voltage for All Quadrants vs. Junction Temperature

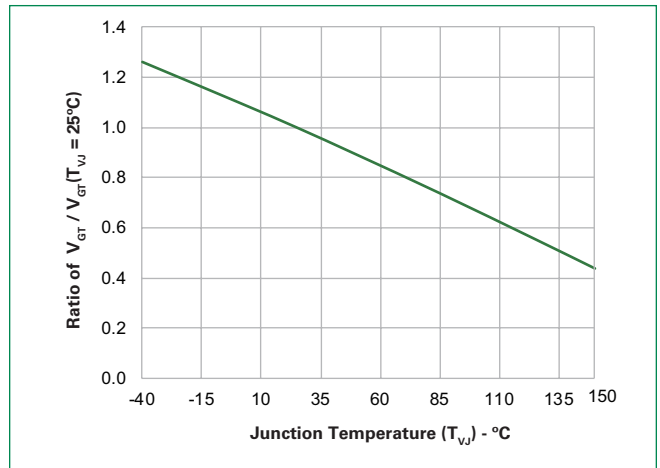

Figure 5: Power Dissipation (Typical) vs. RMS On-State Current

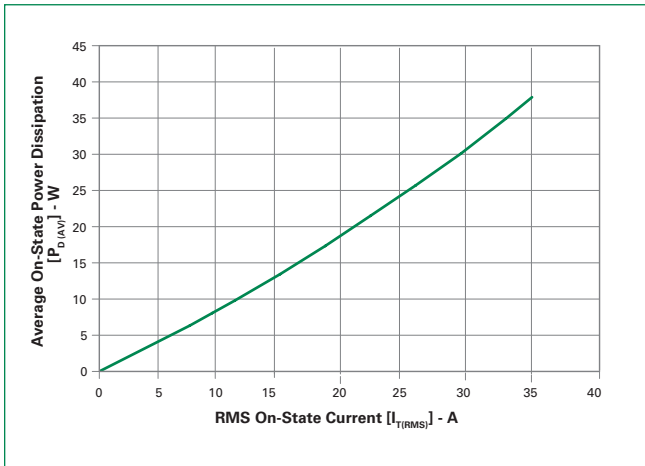

Figure 6: On-State Current vs. On-State Voltage (Typical)

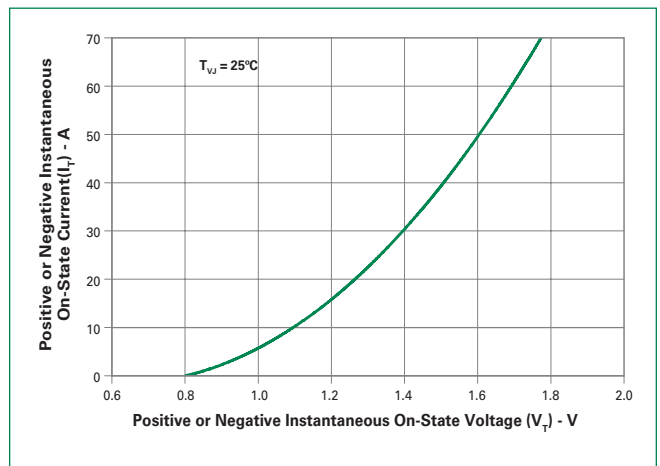
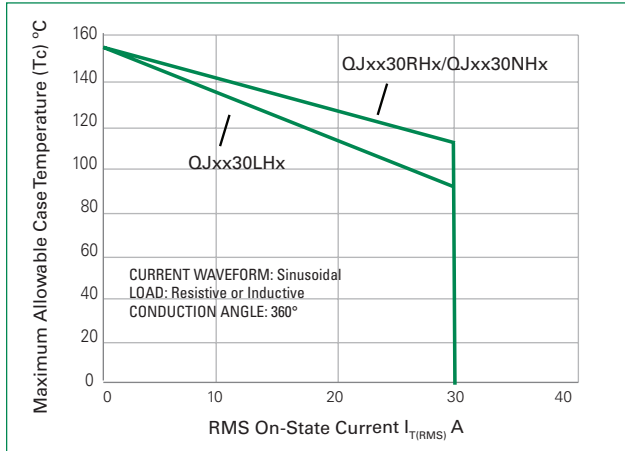
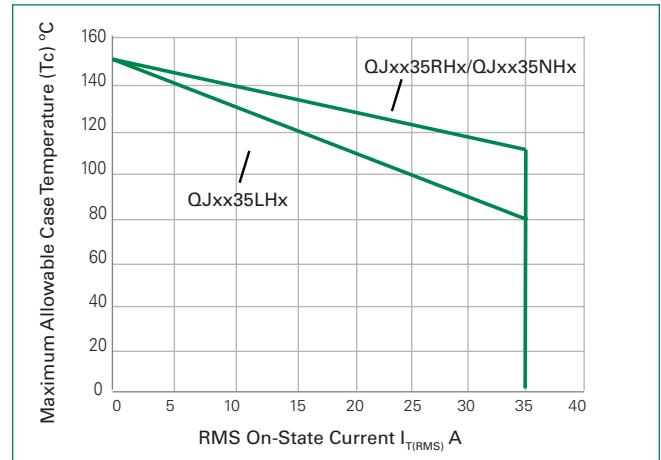
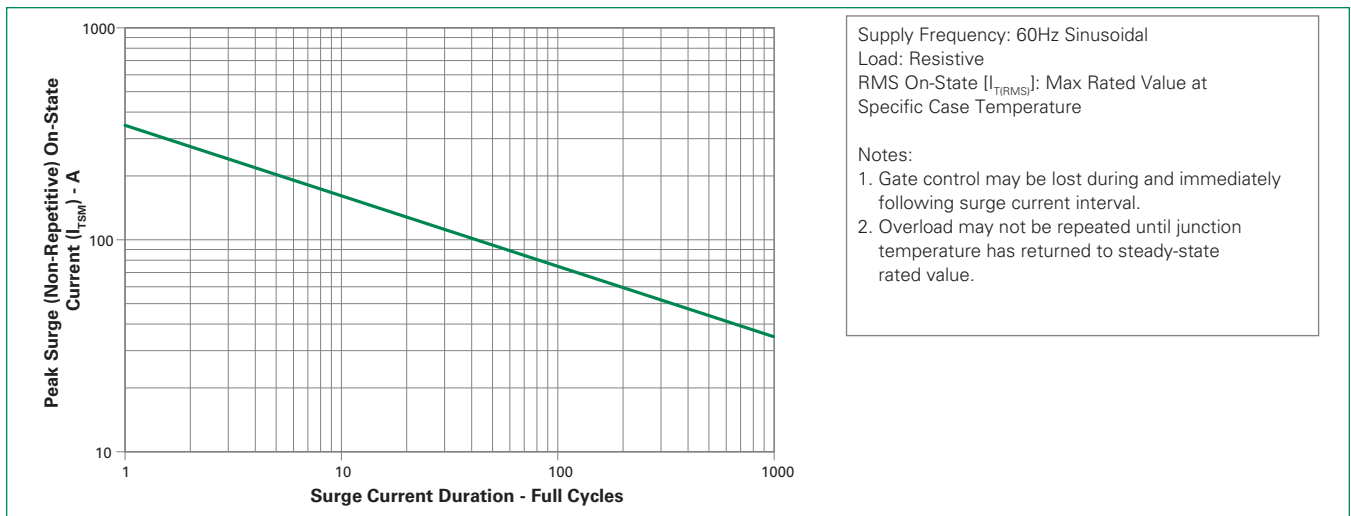
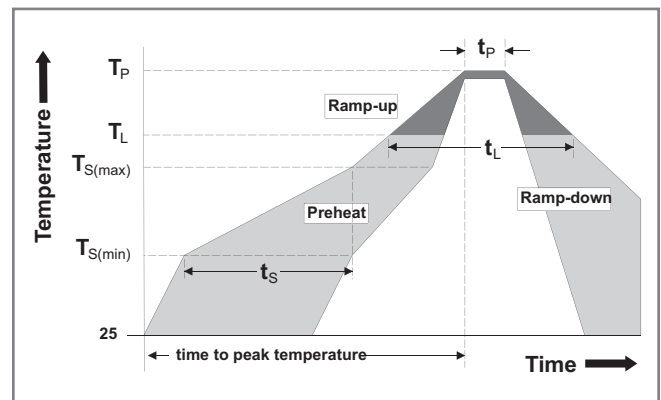

Figure 7: Maximum Allowable Case Temperature vs. RMS On-State Current

Figure 8: Maximum Allowable Case Temperature vs. RMS On-State Current

Figure 9: Surge Peak On-State Current vs. Number of Cycles

Soldering Parameters

Reflow Condition		Pb – Free assembly
Pre Heat	- Temperature Min ($T_{s(min)}$)	150°C
	- Temperature Max ($T_{s(max)}$)	200°C
	- Time (min to max) (t_s)	60 – 180 secs
Average ramp up rate (Liquidus Temp) (T_L) to peak		5°C/second max
$T_{s(max)}$ to T_L - Ramp-up Rate		5°C/second max
Reflow	- Temperature (T_L) (Liquidus)	217°C
	- Time (t_L)	60 – 150 seconds
Peak Temperature (T_p)		260 ^{+0/-5} °C
Time within 5°C of actual peak Temperature (t_p)		20 – 40 seconds
Ramp-down Rate		5°C/second max
Time 25°C to peak Temperature (T_p)		8 minutes Max.
Do not exceed		280°C



Physical Specifications

Terminal Finish	100% Matte Tin-plated
Body Material	UL Recognized compound meeting flammability rating V-0
Terminal Material	Copper Alloy

Design Considerations

Careful selection of the correct component for the application's operating parameters and environment will go a long way toward extending the operating life of the Thyristor. Good design practice should limit the maximum continuous current through the main terminals to 75% of the component rating. Other ways to ensure long life for a power discrete semiconductor are proper heat sinking and selection of voltage ratings for worst case conditions. Overheating, overvoltage (including dv/dt), and surge currents are the main killers of semiconductors. Correct mounting, soldering, and forming of the leads also help protect against component damage.

Environmental Specifications

Test	Specifications and Conditions
AC Blocking	MIL-STD-750, M-1040, Cond A Applied Peak AC voltage @ 150°C for 1008 hours
Temperature Cycling	MIL-STD-750, M-1051, 1000 cycles; -55°C to +150°C; 15-min dwell time
Temperature/Humidity	EIA / JEDEC, JESD22-A101 1008 hours; 320 V - DC: 85°C; 85% rel humidity
Resistance to Solder Heat	MIL-STD-750 Method 2031
Solderability	ANSI/J-STD-002, category 3, Test A
Lead Bend	MIL-STD-750, M-2036 Cond E
Moisture Sensitivity Level	Level 1, JEDEC-J-STD-020
UHASt	JESD22A-118, 96 hrs, 130°C/85% RH
IOL	MIL-STD-750 Method 1037

Dimensions — TO-220AB (L-Package) — Isolated Mounting Tab

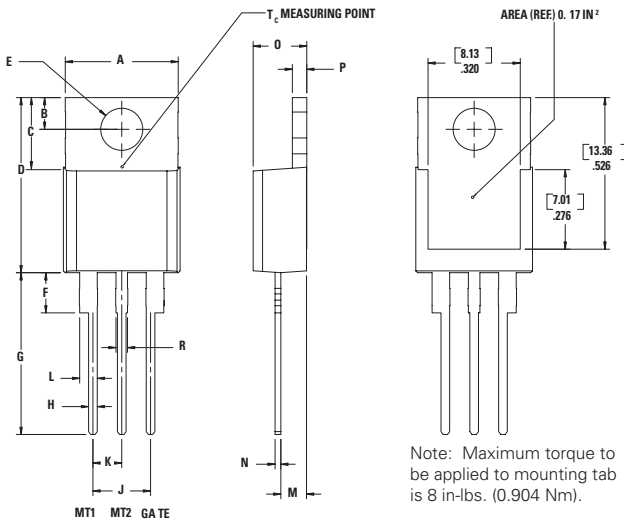

Dimension	Inches		Millimeters	
	Min	Max	Min	Max
A	0.380	0.420	9.65	10.67
B	0.105	0.115	2.67	2.92
C	0.230	0.250	5.84	6.35
D	0.590	0.620	14.99	15.75
E	0.142	0.147	3.61	3.73
F	0.110	0.130	2.79	3.30
G	0.540	0.575	13.72	14.60
H	0.025	0.035	0.64	0.89
J	0.195	0.205	4.95	5.21
K	0.095	0.105	2.41	2.67
L	0.060	0.075	1.52	1.91
M	0.085	0.095	2.16	2.41
N	0.018	0.024	0.46	0.61
O	0.178	0.188	4.52	4.78
P	0.045	0.060	1.14	1.52
R	0.038	0.048	0.97	1.22

Dimensions — TO-220AB (R-Package) — Non-Isolated Mounting Tab Common with Center Lead

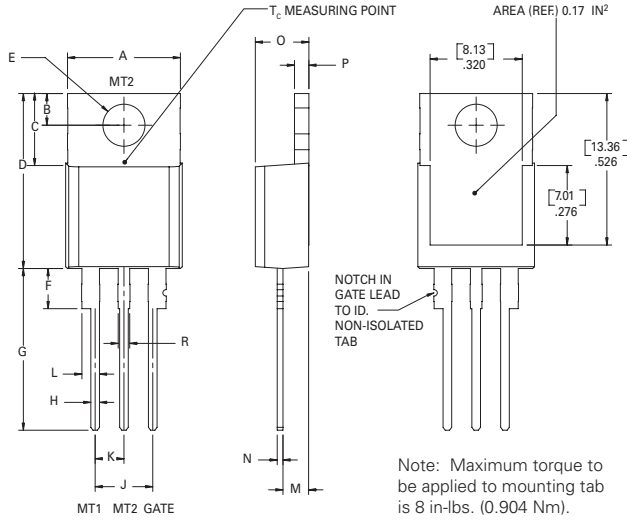

Dimension	Inches		Millimeters	
	Min	Max	Min	Max
A	0.380	0.420	9.65	10.67
B	0.105	0.115	2.67	2.92
C	0.230	0.250	5.84	6.35
D	0.590	0.620	14.99	15.75
E	0.142	0.147	3.61	3.73
F	0.110	0.130	2.79	3.30
G	0.540	0.575	13.72	14.61
H	0.025	0.035	0.64	0.89
J	0.195	0.205	4.95	5.21
K	0.095	0.105	2.41	2.67
L	0.060	0.075	1.52	1.91
M	0.085	0.095	2.16	2.41
N	0.018	0.024	0.46	0.61
O	0.178	0.188	4.52	4.78
P	0.045	0.060	1.14	1.52
R	0.038	0.048	0.97	1.22

Dimensions — TO-263 (N-Package) — D² Pak Surface Mount

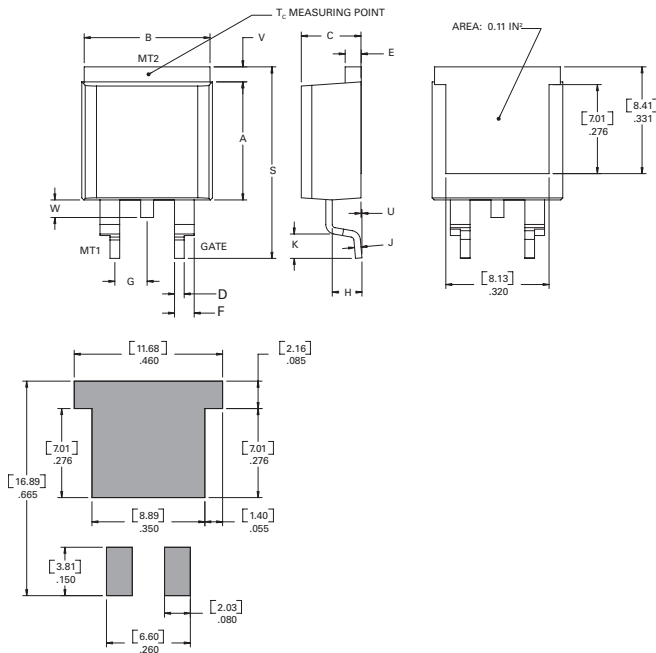

Dimension	Inches		Millimeters	
	Min	Max	Min	Max
A	0.360	0.370	9.14	9.40
B	0.380	0.420	9.65	10.67
C	0.178	0.188	4.52	4.78
D	0.025	0.035	0.64	0.89
E	0.045	0.060	1.14	1.52
F	0.060	0.075	1.52	1.91
G	0.095	0.105	2.41	2.67
H	0.092	0.102	2.34	2.59
J	0.018	0.024	0.46	0.61
K	0.090	0.110	2.29	2.79
S	0.590	0.625	14.99	15.88
V	0.035	0.045	0.89	1.14
U	0.002	0.010	0.05	0.25
W	0.040	0.070	1.016	1.78

Product Selector

Part Number	Voltage		Gate Sensitivity Quadrants I – II – III	I _{T(RMS)}	Type	Package
	600V	800V				
QJxx30LH4	x	x	35 mA	30 A	Alternistor TRIAC	TO-220L
QJxx30RH4	x	x	35 mA	30 A	Alternistor TRIAC	TO-220R
QJxx30NH4	x	x	35 mA	30 A	Alternistor TRIAC	TO-263 D ² PAK
QJxx30LH5		x	50 mA	30 A	Alternistor TRIAC	TO-220L
QJxx30RH5		x	50 mA	30 A	Alternistor TRIAC	TO-220R
QJxx30NH5		x	50 mA	30 A	Alternistor TRIAC	TO-263 D ² PAK
QJxx35LH4	x	x	35 mA	35 A	Alternistor TRIAC	TO-220L
QJxx35RH4	x	x	35 mA	35 A	Alternistor TRIAC	TO-220R
QJxx35NH4	x	x	35 mA	35 A	Alternistor TRIAC	TO-263 D ² PAK
QJxx35LH5		x	50 mA	35 A	Alternistor TRIAC	TO-220L
QJxx35RH5		x	50 mA	35 A	Alternistor TRIAC	TO-220R
QJxx35NH5		x	50 mA	35 A	Alternistor TRIAC	TO-263 D ² PAK

Note: xx = Voltage/10

Packing Options

Part Number	Marking	Weight	Packing Mode	Base Quantity
QJxx30LHxTP	QJxx30LHx	2.2	Tube	1000 (50 per tube)
QJxx30RHxTP	QJxx30RHx	2.2	Tube	1000 (50 per tube)
QJxx30NHxTP	QJxx30NHx	1.6	Tube	1000 (50 per tube)
QJxx30NHxRP	QJxx30NHx	1.6	Embossed Carrier	500
QJxx35LHxTP	QJxx35LHx	2.2	Tube	1000 (50 per tube)
QJxx35RHxTP	QJxx35RHx	2.2	Tube	1000 (50 per tube)
QJxx35NHxTP	QJxx35NHx	1.6	Tube	1000 (50 per tube)
QJxx35NHxRP	QJxx35NHx	1.6	Embossed Carrier	500

Note: xx = Voltage/10

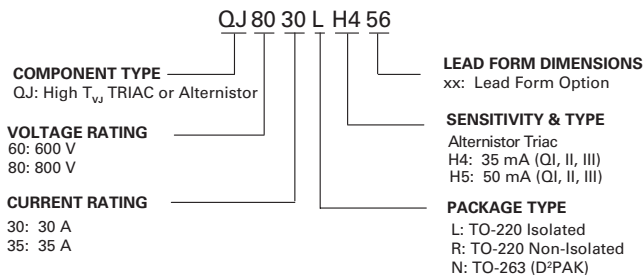
Part Numbering System

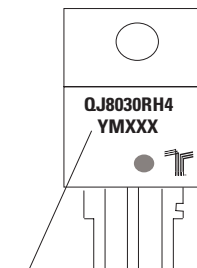
Part Marking System

 TO-220 AB - (L and R Package)
 TO-263 AB - (N Package)

 Date Code Marking
 Y: Year Code
 M: Month Code
 XXX: Lot Trace Code

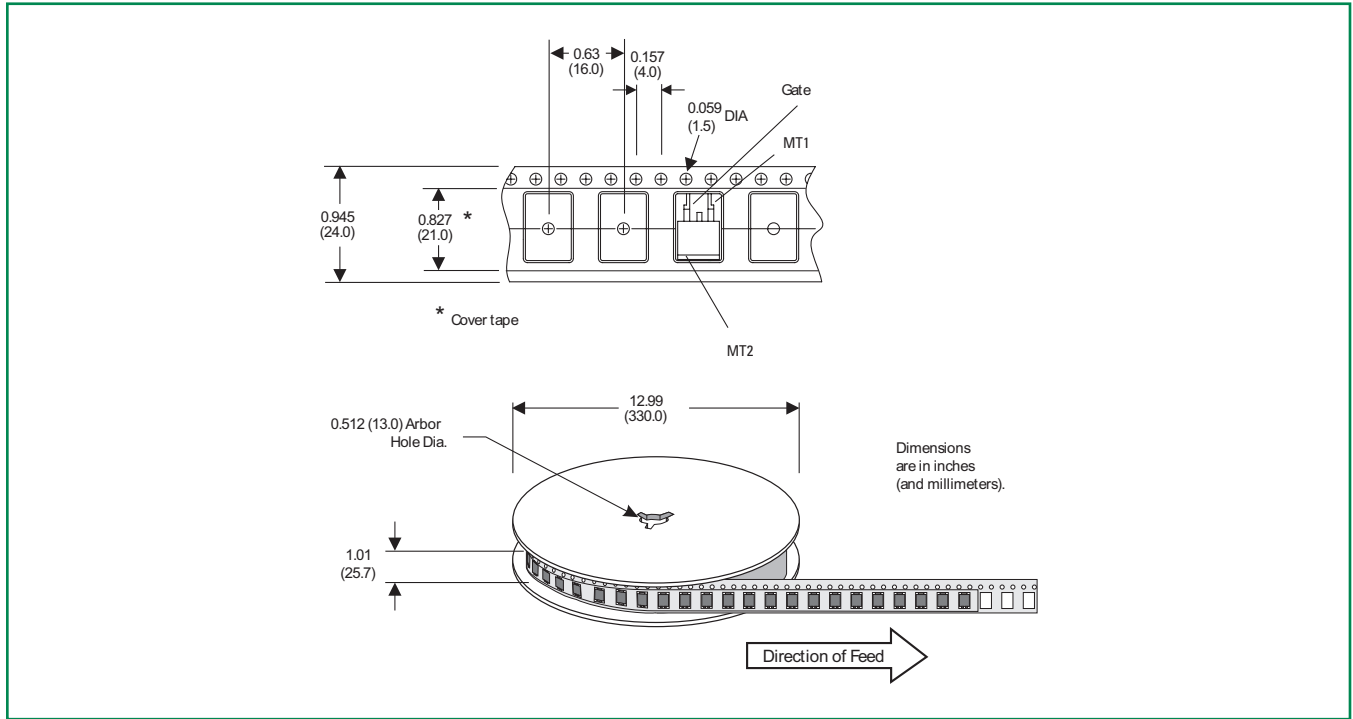
TO-263 Embossed Carrier Reel Pack (RP) Specifications

Meets all EIA-481-2 Standards



Disclaimer Notice

Information furnished is believed to be accurate and reliable. However, users should independently evaluate the suitability of and test each product selected for their own applications. Littelfuse products are not designed for, and may not be used in, all applications.

Read complete Disclaimer Notice at <http://www.littelfuse.com/disclaimer-electronics>.



Part of:

