

# Ultrafast Recovery Rectifier

DURB2020CT, 2x 10A, 200V, TO-263, Common Cathode

DURB2020CT

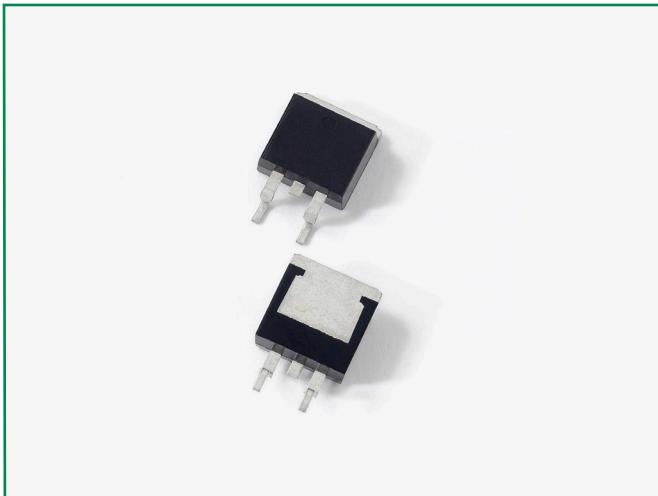

## Description

Littelfuse DUR series Ultrafast Recovery Rectifier is designed to meet the general requirements of commercial applications by providing low  $T_{rr}$ , high-temperature, low-leakage and low forward voltage drop products. It is suitable for output rectifier, free-wheeling or boost diode in high-frequency power switching application such as switch mode power supply and DC-DC converters.

## Features

- Ultra-fast switching
- Low reverse leakage current
- High surge current capability
- Low forward voltage drop
- Common cathode configuration in surface mount TO-263 (D<sup>2</sup>PAK) package
- Pb-free E3 means 2nd level interconnect is Pb-free and the terminal finish material is tin(Sn) (IPC/JEDEC J-STD-609A.01)

## Circuit Diagram

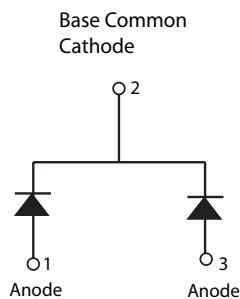

## Applications

- Output rectifiers in switch mode power supplies (SMPS) and DC to DC converters
- Free-wheeling diode or boost diode in converters and motor control circuits
- Anti-parallel diode for high frequency switching devices such as IGBT
- Uninterruptible Power Supplies (UPS)
- Inductive heating and melting
- Ultrasonic cleaners and welders

## Maximum Ratings

Characteristics	Symbol	Conditions	Max.	Unit
Peak Inverse Voltage	$V_{RWM}$	-	200	V
Average Rectified Forward Current	$I_{F(AV)}$	50% duty cycle @ $T_c = 100^\circ\text{C}$ , rectangular wave form	10 (Per Leg)	A
			20 (Total Device)	
Peak One Cycle Non-Repetitive Surge Current (per leg)	$I_{FSM}$	8.3 ms, half sine pulse	125	A

## Electrical Characteristics

Characteristics	Symbol	Conditions	Max.	Unit
Forward Voltage Drop ( Per Leg) <sup>1</sup>	$V_F$	@ $I_F = 10\text{A}$ , Pulse, $T_J = 25^\circ\text{C}$	1.15	V
Reverse Current	$I_{R1}$	@ $V_R = \text{Rated } V_R$ , $T_J = 25^\circ\text{C}$	15	$\mu\text{A}$
	$I_{R2}$	@ $V_R = \text{Rated } V_R$ , $T_J = 125^\circ\text{C}$	250	$\mu\text{A}$
Junction Capacitance	$C_T$	Bias=5V, 10KHZ	60	pF
Reverse Recovery Time	$t_{rr1}$	$I_F = 500\text{mA}$ , $I_R = 1\text{A}$ , and $I_{rm} = 250\text{mA}$	35	ns

Footnote 1: Pulse Width < 300 $\mu\text{s}$ , Duty Cycle < 2%

**Thermal-Mechanical Specifications**

Characteristics	Symbol	Conditions	Specification	Unit
Junction Temperature	$T_J$	-	-55 to +150	°C
Storage Temperature	$T_{stg}$	-	-55 to +150	°C
Typical Thermal Resistance Junction to Case	$R_{\theta JC}$	DC operation	3.5	°C/W
Typical Thermal Resistance Junction to Ambient	$R_{\theta JA}$	DC operation	50	°C/W
Approximate Weight	wt	-	1.41	g
Case Style	-	D <sup>2</sup> PAK	-	-

**Figure 1: Typical Forward Characteristics**

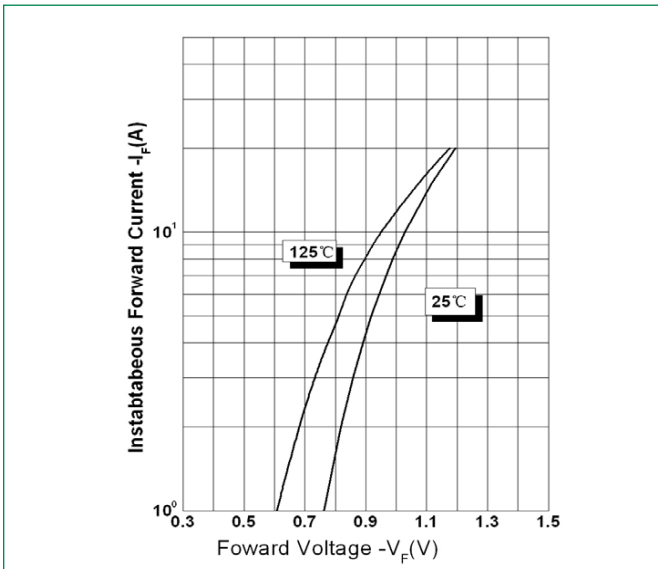

**Figure 2: Typical Reverse Characteristics**

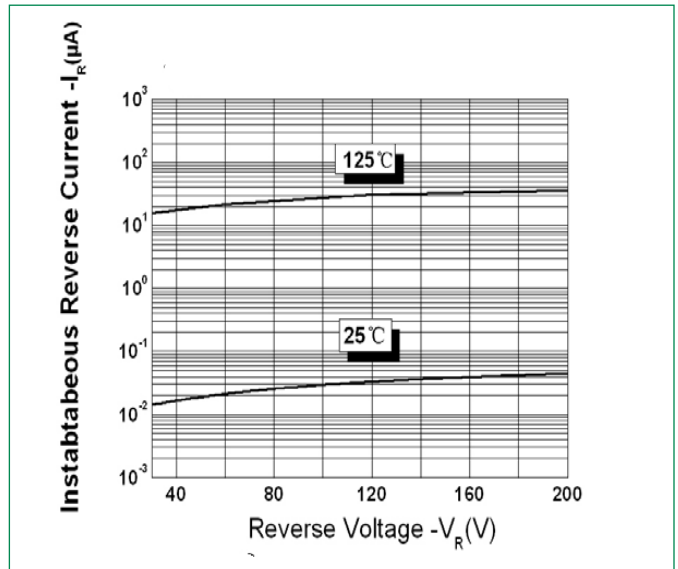

**Figure 3: Typical Junction Capacitance**

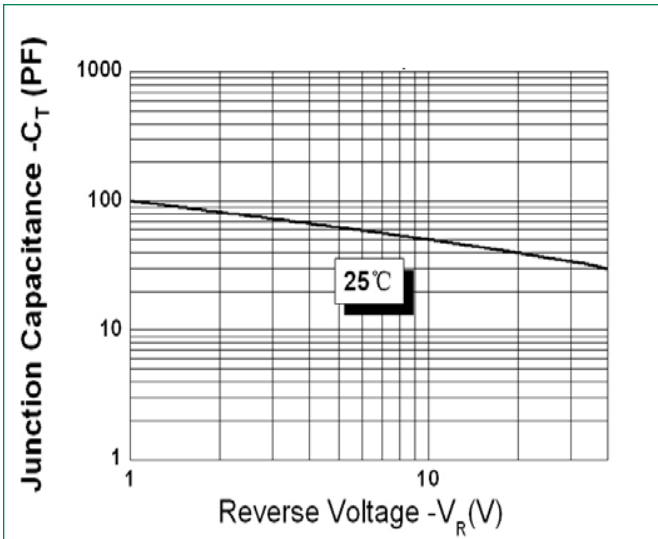

**Part Numbering and Marking System**

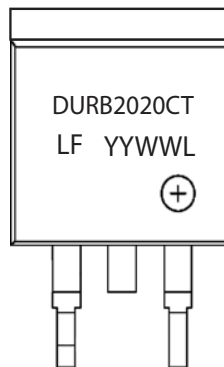

- DUR = Device Type
- B = Package type
- 20 = Forward Current (20A)
- 20 = Reverse Voltage (200V)
- CT = Configuration
- LF = Littelfuse
- YY = Year
- WW = Week
- L = Lot Number

# Ultrafast Recovery Rectifier

DURB2020CT, 2x 10A, 200V, TO-263, Common Cathode

## Packing Options

Part Number	Marking	Packing Mode	M.O.Q
DURB2020CT	DURB2020CT	800pcs / reel	800

## Dimensions-Package TO-263 (D<sup>2</sup>PAK)

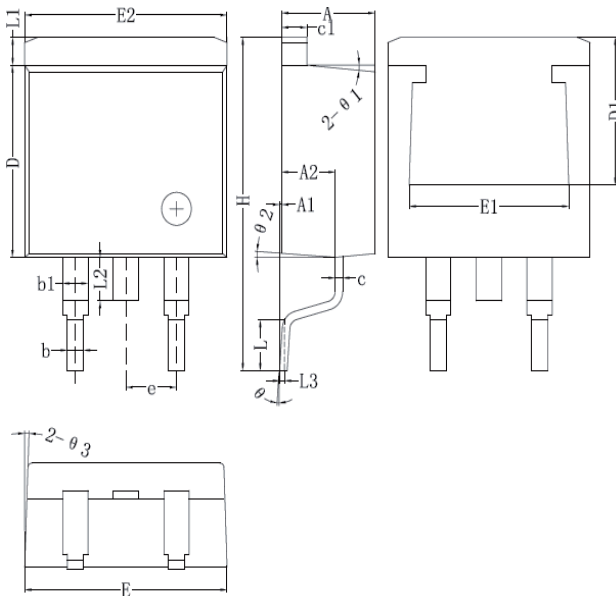

	Millimeters	
	Min	Max
<b>A</b>	4.06	4.83
<b>A1</b>	0.00	0.25
<b>b</b>	0.51	0.99
<b>b1</b>	1.14	1.78
<b>c</b>	0.31*	0.74
<b>c1</b>	1.14	1.65
<b>D</b>	8.38	9.65
<b>D1</b>	6.40*	-
<b>E</b>	9.65	10.67
<b>E1</b>	6.22	-
<b>E2</b>	9.65	10.67
<b>e</b>	2.54 BSC	
<b>H</b>	14.60*	15.88
<b>L</b>	1.78	2.79
<b>L1</b>	-	1.68
<b>L2</b>	-	1.78
<b>L3</b>	0.254 BSC	

Footnote \*: The spec. does not comply with JEDEC spec.

## Carrier Tape & Reel Specification TO-263 (D<sup>2</sup>PAK)

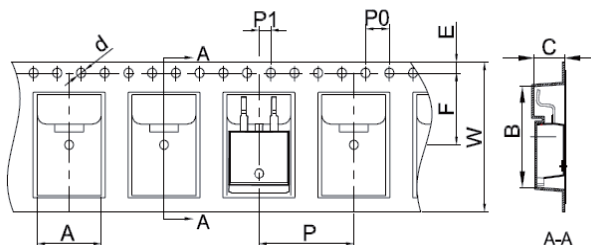

	Millimeters	
	Min	Max
<b>A</b>	10.70	10.90
<b>B</b>	16.03	16.23
<b>C</b>	5.11	5.31
<b>d</b>	ø1.45	ø1.65
<b>E</b>	1.65	1.85
<b>F</b>	11.40	11.60
<b>P0</b>	3.90	4.10
<b>p</b>	15.90	16.10
<b>P1</b>	1.90	2.10
<b>W</b>	23.90	24.30