

BF1

Bolt-down Fuse Rated 58V

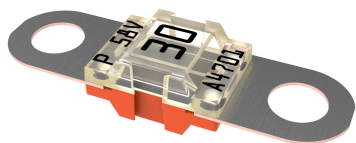

2 Holes M6 version

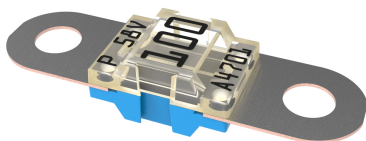

2 Holes M5 version

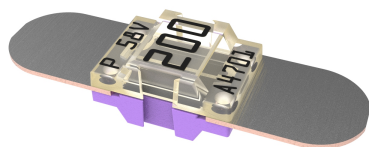

No-Holes version

Description

BF1 58V fuses use Slo-Blo® technology to protect high-current wiring harnesses. Use the 150 A and 200 A fuses only for short circuit protection.

Specifications

Voltage Rating:	58 VDC
Interrupting Rating:	1000A @58 VDC
Recommended Environmental Temperature:	-40°C to +125°C
Terminals Material:	Tin plated Copper
Opaque Housing Material:	PET-GF33 (U.L. 94 Flammability rating – V0)
Clear Housing Material:	PES (U.L. 94 Flammability rating – HB)
Mounting Torque M5:	4.5 Nm +/- 1Nm
Mounting Torque M6:	6.0 Nm +/- 1Nm
Complies with:	UL 248 Special Purpose Fuse
Refers To:	ISO 8820-5:2015

Applications

- Cars
- Trucks
- SUVs
- Offroad vehicles
- Buses
- Watercraft as approved by Littelfuse®

Features & Benefits

- Color coding indicates ampere rating
- High-contrast ampere rating stamps aid identification
- Available with one, two or no mounting holes
- Transparent cover make it easier to see when fuse blow

Ordering Information

Part Number	Rating	Package Size	Bolt Size	Bolt Hole Qty
142.5631.xxxx	30 - 200	500	M5	2
142.7010.xxxx	30 - 200	500	M6	2
142.0020.xxxx	30 - 200	500	N/A	0

BF1

Bolt-down Fuse Rated 58V

Ratings

Part Number M5	Part Number M6	Current Rating (A)	Housing Material Color	Test Cable Size (mm ²)	Typ. Voltage Drop (mV)	Typ. Cold Resistance (mΩ)	Typ. I ² t (A ² s)
142.5631.5302 ¹	142.7010.5302 ¹	30	Orange	2.5	105	2.70	5,100
142.5631.5402	142.7010.5402	40	Green	4	90	1.56	6,800
142.5631.5502	142.7010.5502	50	Red	6	80	1.03	6,900
142.5631.5602	142.7010.5602	60	Yellow	6	75	0.75	16,200
142.5631.5702	142.7010.5702	70	Brown	10	70	0.64	22,000
142.5631.5802	142.7010.5802	80	White	10	70	0.55	25,600
142.5631.6102	142.7010.6102	100	Blue	16	70	0.44	42,500
142.5631.6122	142.7010.6122	125	Pink	25	70	0.34	62,500
142.5631.6152	142.7010.6152	150	Grey	25	70	0.29	83,400
142.5631.6202 ²	142.7010.6202	200	Purple	35	70	0.24	126,000

Note 1: Not UL rated

Note 2: Short Circuit Protector only

The typical I²t is an average value calculated from the breaking capacity tests by using the melting time before the arcing occurs.

Dimensions

Dimensions in mm for reference only.

See outline drawing for dimensions and tolerances.

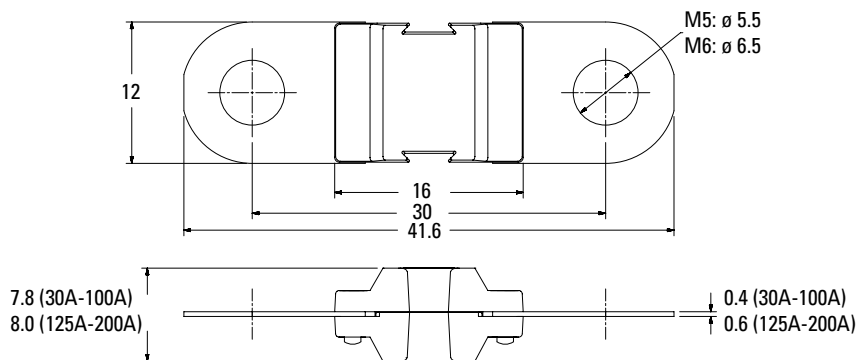

No Holes versions

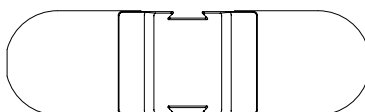

BF1

Bolt-down Fuse Rated 58V

Time-Current Characteristic Curves

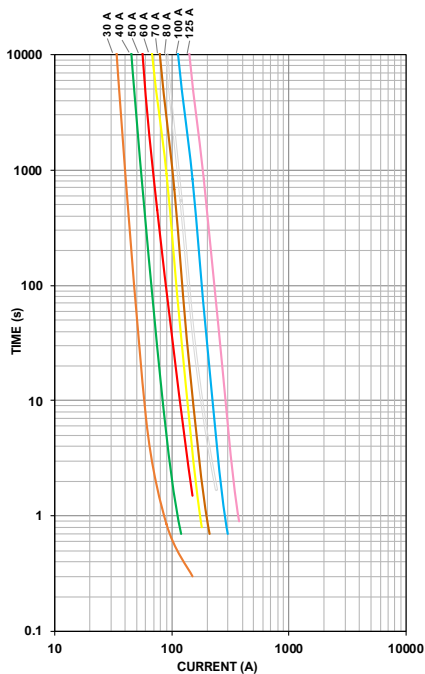

Time-Current Characteristics

Time-Current Characteristics

% of Rating	Opening Time Min / Max (s)	
	30-125A	150-200 A
75	- / -	360,000 / ∞
100	360,000 / ∞	- / -
110	14,400 / ∞	- / -
150	90 / 3,600	- / -
200	3 / 100	1 / 15
300	0.3 / 3	- / -
350	- / -	0.3 / 5
500	0.1 / 1	- / -
600	- / -	0.1 / 1

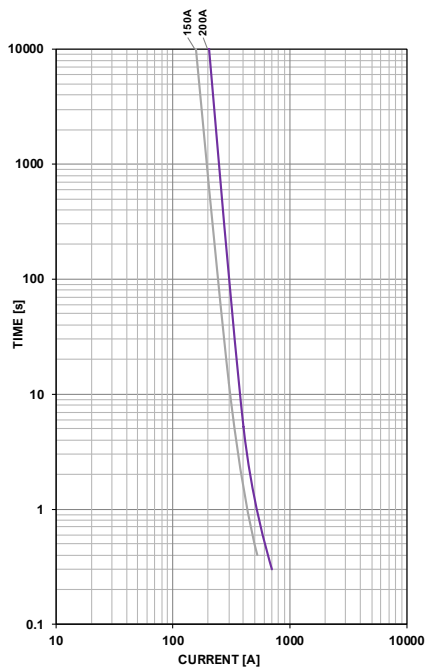

BF1

Bolt-down Fuse Rated 58V

Typical Derating of Fuse Melting Element

Temperature Security Margin is 20%

Wire Cross Section And Fixture Test Set Up Refer To ISO 8820-3

Please Contact Littelfuse® For Details Regarding Derating Test Set Up

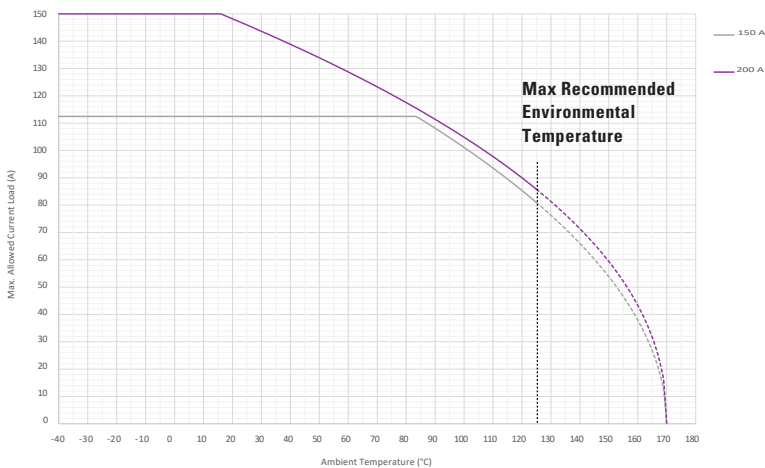
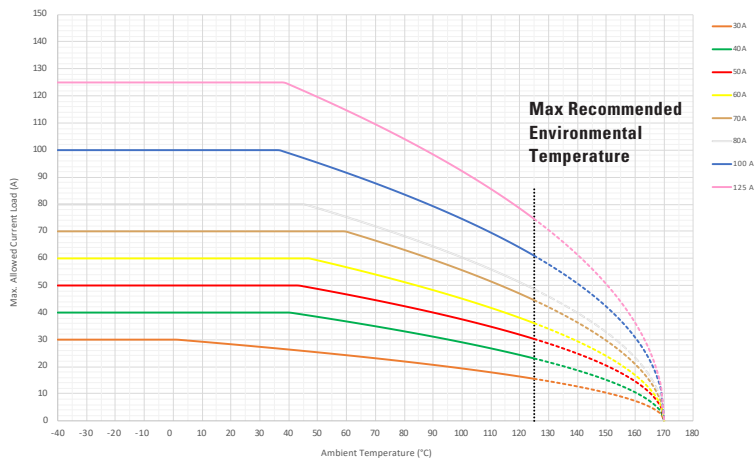

Temperature Table

	max. allowed current load (A) at ambient temperature (typical derating)						
	-40°C	0°C	20°C	65°C	85°C	110°C	125°C
30 A	30	30	28	24	21	18	16
40 A	40	40	40	36	32	27	23
50 A	50	50	50	46	41	35	30
60 A	60	60	60	55	50	42	36
70 A	70	70	70	68	61	51	45
80 A	80	80	80	74	66	56	49
100 A	100	100	100	90	81	70	61
125 A	125	125	125	112	101	86	75
150 A	113	113	113	113	111	94	81
200 A	150	150	148	126	115	98	86

Derating curves may change depending on the final condition of the application (terminals characteristics, wire size etc..). Please ask Littelfuse® for more information.