

# MEDIUM VOLTAGE FUSES

2,400-38,000 VAC • Current-Limiting



## Description

Littelfuse® offers a selection of E- and R-rated medium voltage fuses for the protection of transformers, potential transformers, feeders, and motor circuits. Single, double, and triple barrel designs are available to cover a wide range of current, voltage, and interrupting ratings. Conventional ferrule type, clip lock, and bolt-in mounting configurations are available for virtually any application. Hermetically sealed fuses for use in hazardous environments are also offered.

For additional fuse ratings or custom mounting configurations, contact Littelfuse Technical Support at 1-800-TEC-FUSE or [techline@littelfuse.com](mailto:techline@littelfuse.com).

## Applications

- Power Transformer Protection
- Potential Transformer Protection
- Motor Controller Back-up Protection
- Fused Switches
- Feeder Circuits



Current-limiting E- and R-rated fuses are equipped with a mechanical indicator or striker pin that protrudes through the fuse cap upon operation of the fuse. This provides visual identification of a blown fuse and can be used as a trigger for external devices.

*Note: Extension distance 1/2" minimum; extension force 2 lb. minimum.*

## General Information

The terms "Medium Voltage" and "High Voltage" have been used interchangeably by many people to describe fuses operating above 600 volts. Technically speaking, medium voltage fuses are those intended for the voltage range from 2,400 to 38,000 Vac. High voltage fuses are for circuits carrying voltages greater than 38,000 Vac.

E-rated fuses are considered to be general purpose fuses and can be used to protect against low and high values of fault current. R-rated fuses are designed for back-up protection. They must be used in series with other devices such as motor overload relays in order to achieve both overload and short-circuit protection.

Medium voltage fuses are not intended to provide overload protection in the same sense as fuses rated 600 volts or less. Medium voltage fuse current ratings do not have the same meanings as the ampere ratings of low voltage fuses.

All medium voltage fuses are limited in their ability to interrupt low value overcurrents, especially those between 100% and 200% of the fuse's continuous current rating. They are designed to carry their rated current without exceeding the temperature rise permitted by NEMA and ANSI standards.



Bolt-in Mount Fuses

**Disclaimer Notice** – Information furnished is believed to be accurate and reliable. However, users should independently evaluate the suitability of and test each product selected for their own applications. Littelfuse products are not designed for, and may not be used in, all applications. Read complete Disclaimer Notice at [www.littelfuse.com/product-disclaimer](http://www.littelfuse.com/product-disclaimer).

# R-RATED MEDIUM VOLTAGE FUSES

## Description

R-rated fuses provide required short-circuit protection for medium voltage motors, motor controllers and associated circuitry. These components have limited ability to absorb the energy of large short-circuit currents. Medium voltage motor controllers contain overload relays which provide both overload protection and locked rotor protection to the motor. The controllers are also intended to interrupt low value short-circuits within the capability of the motor controller. This protects the medium voltage fuse from sustained overcurrents which are less than their minimum interrupting rating.

NEMA Standards for R-rated medium voltage power fuses require they operate within 15-35 seconds when subjected to an rms current 100 times the R rating. For example, a fuse with a 2R rating will open within 15 to 35 seconds on an applied current of  $2 \times 100 = 200$  amperes.

## Ordering Number

**130-4R-1C-5.5**

- Max Voltage (KV)
- Style:
  - C (Cartridge)
  - B (Bolt Mount)
  - IB (Inverted Bolt Mount)
  - BI (Bolt-In Mount)
- No. of Barrels
- Rating (size)
- Continuous Current

## Dimensions

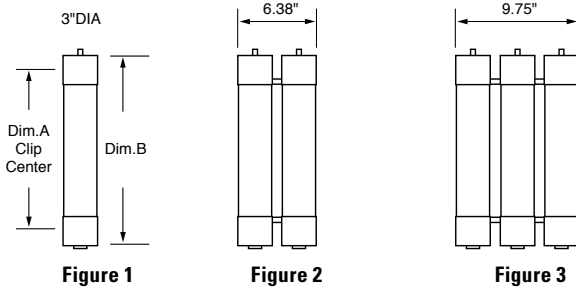

**Cartridge "C"**

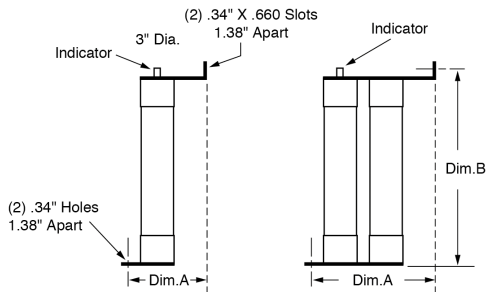

**Bolt Mount "B"**

Sample Part #: 130-4R-1B-5.5

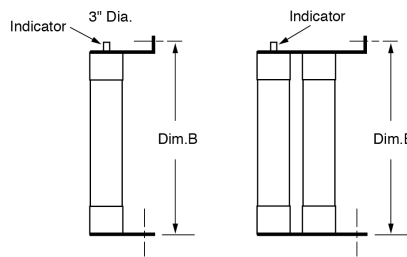

**Inverted-Bolt "IB"**

Sample Part #: 130-4R-1IB-5.5

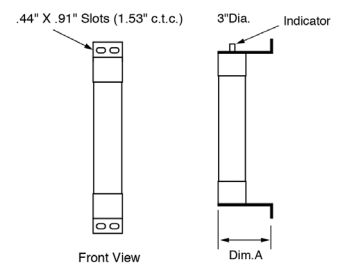

**Bolt-In Mount "BI"**

Sample Part #: 130-4R-1BI-5.5

## Characteristics

**Voltage Ratings** 2,750 V – 8,250 V  
**Current Range** 2R – 36R

## Options

- Hermetically sealed for use in hazardous locations (add "S" suffix to part number)
- Bolt-in mounting configurations



### Hookey Feature\*

For hookey attachment; add "W" suffix to part number

\*See web for Bolt Mount, Inverted Bolt Mount, and Bolt-In dimensions

## Medium Voltage Fuse Protection

POWR-GARD® medium voltage fuses provide short-circuit protection for motors and transformers rated 2,400 to 38,000 volts AC.

Visit [littelfuse.com/MediumVoltage](http://littelfuse.com/MediumVoltage) to download the white paper featuring protection tables, sizing recommendations, and applications.



# R-RATED MEDIUM VOLTAGE FUSES

| R RATED      | ORDERING/<br>CATALOG<br>NUMBER | SIZE | MAXIMUM<br>CONTINUOUS<br>CURRENT @<br>40 DEGREES C° | DIM. A<br>(INCHES) | DIM. B<br>(INCHES) | MINIMUM<br>INTERRUPTING<br>RATING RMS<br>AMPS | MAXIMUM<br>INTERRUPTING<br>RATING RMS<br>(ASYM)* | FIGURE<br>NUMBER |
|--------------|--------------------------------|------|---|--------------------|--------------------|---|--|------------------|
| 2.75 KV      | 702R1C2.75                     | 2R   | 70  | 7"                 | 10.875"            | 170   | 80,000   | 1                |
|              | 1003R1C2.75                    | 3R   | 100   | 7"                 | 10.875"            | 250   | 80,000   | 1                |
|              | 1304R1C2.75                    | 4R   | 130   | 7"                 | 10.875"            | 340   | 80,000   | 1                |
|              | 1505R1C2.75                    | 5R   | 150   | 7"                 | 10.875"            | 390   | 80,000   | 1                |
|              | 1706R1C2.75                    | 6R   | 170   | 7"                 | 10.875"            | 500   | 80,000   | 1                |
|              | 2009R1C2.75                    | 9R   | 200   | 7"                 | 10.875"            | 760   | 80,000   | 1                |
|              | 23012R1C2.75                   | 12R  | 230   | 7"                 | 10.875"            | 1000  | 80,000   | 1                |
|              | 39018R2C2.75                   | 18R  | 390   | 7"                 | 10.875"            | 1500  | 80,000   | 2                |
| 45024R2C2.75 | 24R                            | 450  | 7"  | 10.875"            | 1950               | 80,000  | 2  |                  |

| R RATED     | ORDERING/<br>CATALOG<br>NUMBER | SIZE | MAXIMUM<br>CONTINUOUS<br>CURRENT @<br>40 DEGREES C° | DIM. A<br>(INCHES) | DIM. B<br>(INCHES) | MINIMUM<br>INTERRUPTING<br>RATING RMS<br>AMPS | MAXIMUM<br>INTERRUPTING<br>RATING RMS<br>(ASYM)* | FIGURE<br>NUMBER |
|-------------|--------------------------------|------|---|--------------------|--------------------|---|--|------------------|
| 5.5 KV      | 702R1C5.5                      | 2R   | 70  | 12"                | 15.875"            | 170   | 80,000   | 1                |
|             | 1003R1C5.5                     | 3R   | 100   | 12"                | 15.875"            | 250   | 80,000   | 1                |
|             | 1304R1C5.5                     | 4R   | 130   | 12"                | 15.875"            | 340   | 80,000   | 1                |
|             | 1505R1C5.5                     | 5R   | 150   | 12"                | 15.875"            | 390   | 80,000   | 1                |
|             | 1706R1C5.5                     | 6R   | 170   | 12"                | 15.875"            | 500   | 80,000   | 1                |
|             | 2009R1C5.5                     | 9R   | 200   | 12"                | 15.875"            | 760   | 80,000   | 1                |
|             | 23012R1C5.5                    | 12R  | 230   | 12"                | 15.875"            | 1000  | 80,000   | 1                |
|             | 39018R2C5.5                    | 18R  | 390   | 12"                | 15.875"            | 1500  | 80,000   | 2                |
|             | 45024R2C5.5                    | 24R  | 450   | 12"                | 15.875"            | 1950  | 80,000   | 2                |
|             | 48026R2C5.5                    | 26R  | 480   | 12"                | 15.875"            | 2100  | 80,000   | 2                |
|             | 55030R2C5.5                    | 30R  | 550   | 12"                | 15.875"            | 2400  | 80,000   | 2                |
|             | 60032R2C5.5                    | 32R  | 600   | 12"                | 15.875"            | 2600  | 80,000   | 2                |
|             | 65036R2C5.5                    | 36R  | 650   | 12"                | 15.875"            | 2900  | 80,000   | 2                |
|             | 55030R3C5.5                    | 30R  | 550   | 12"                | 15.875"            | 2400  | 80,000   | 3                |
|             | 60032R3C5.5                    | 32R  | 600   | 12"                | 15.875"            | 2600  | 80,000   | 3                |
| 65036R3C5.5 | 36R                            | 650  | 12"   | 15.875"            | 2900               | 80,000  | 3  |                  |

| R RATED                    | ORDERING/<br>CATALOG<br>NUMBER | SIZE | MAXIMUM<br>CONTINUOUS<br>CURRENT @<br>40 DEGREES C° | DIM. A<br>(INCHES) | DIM. B<br>(INCHES) | MINIMUM<br>INTERRUPTING<br>RATING RMS<br>AMPS | MAXIMUM<br>INTERRUPTING<br>RATING RMS<br>(ASYM)* | FIGURE<br>NUMBER |
|----------------------------|--------------------------------|------|---|--------------------|--------------------|---|--|------------------|
| 5.5 KV<br>14" CLIP CENTERS | 702R1C5.5X                     | 2R   | 70  | 14"                | 17.875"            | 170   | 80,000   | 1                |
|                            | 1003R1C5.5X                    | 3R   | 100   | 14"                | 17.875"            | 250   | 80,000   | 1                |
|                            | 1304R1C5.5X                    | 4R   | 130   | 14"                | 17.875"            | 340   | 80,000   | 1                |
|                            | 1505R1C5.5X                    | 5R   | 150   | 14"                | 17.875"            | 390   | 80,000   | 1                |
|                            | 1706R1C5.5X                    | 6R   | 170   | 14"                | 17.875"            | 500   | 80,000   | 1                |
|                            | 2009R1C5.5X                    | 9R   | 200   | 14"                | 17.875"            | 760   | 80,000   | 1                |
|                            | 23012R1C5.5X                   | 12R  | 230   | 14"                | 17.875"            | 1000  | 80,000   | 1                |
|                            | 39018R2C5.5X                   | 18R  | 390   | 14"                | 17.875"            | 1500  | 80,000   | 2                |
|                            | 45024R2C5.5X                   | 24R  | 450   | 14"                | 17.875"            | 1950  | 80,000   | 2                |
|                            | 55030R2C5.5X                   | 30R  | 550   | 14"                | 17.875"            | 2400  | 80,000   | 2                |

| R RATED      | ORDERING/<br>CATALOG<br>NUMBER | SIZE | MAXIMUM<br>CONTINUOUS<br>CURRENT @<br>40 DEGREES C° | DIM. A<br>(INCHES) | DIM. B<br>(INCHES) | MINIMUM<br>INTERRUPTING<br>RATING RMS<br>AMPS | MAXIMUM<br>INTERRUPTING<br>RATING RMS<br>(ASYM)* | FIGURE<br>NUMBER |
|--------------|--------------------------------|------|---|--------------------|--------------------|---|--|------------------|
| 8.25 KV      | 702R1C8.25                     | 2R   | 70  | 12"                | 15.875"            | 190   | 80,000   | 1                |
|              | 1003R1C8.25                    | 3R   | 100   | 12"                | 15.875"            | 225   | 80,000   | 1                |
|              | 1304R1C8.25                    | 4R   | 130   | 12"                | 15.875"            | 330   | 80,000   | 1                |
|              | 1505R1C8.25                    | 5R   | 150   | 12"                | 15.875"            | 440   | 80,000   | 1                |
|              | 1706R1C8.25                    | 6R   | 170   | 12"                | 15.875"            | 500   | 80,000   | 1                |
|              | 2009R1C8.25                    | 9R   | 200   | 12"                | 15.875"            | 740   | 80,000   | 1                |
|              | 23012R1C8.25                   | 12R  | 230   | 12"                | 15.875"            | 955   | 80,000   | 1                |
|              | 39018R2C8.25                   | 18R  | 390   | 12"                | 15.875"            | 1440  | 80,000   | 2                |
| 45024R2C8.25 | 24R                            | 450  | 12"   | 15.875"            | 1910               | 80,000  | 2  |                  |

\* RMS Asymmetrical amperes = RMS Symmetrical amperes x 1.6

For hookeye attachment add "W" suffix to part number

**Disclaimer Notice** – Information furnished is believed to be accurate and reliable. However, users should independently evaluate the suitability of and test each product selected for their own applications. Littelfuse products are not designed for, and may not be used in, all applications. Read complete Disclaimer Notice at [www.littelfuse.com/product-disclaimer](http://www.littelfuse.com/product-disclaimer).

# E-RATED MEDIUM VOLTAGE FUSES

## Description

E-rated fuses have time current characteristics designed to provide current-limiting protection for power transformers, potential transformers, power centers, feeder centers, and unit sub stations. When properly applied, they can protect against high and low fault currents.

NEMA Standards for E-rated medium voltage fuses require that fuses rated 100E or less open within 300 seconds (5 minutes) when subjected to an RMS value of 200-240% of the fuse continuous current rating; and fuses with an E rating larger than 100E must open within 600 seconds (10 minutes) when subjected to an RMS current of 220-240% of the fuse's continuous current rating. These values establish one point on the time-current curve.

## Application Note

Since these fuses are used for the protection of general purpose circuits which may contain transformers, motors, and other equipment producing in-rush and/or overload currents, fuses should generally be rated at 140% of the normal full load current, and circuits should be analyzed to ensure that system load currents will not exceed the current rating of the fuse.

## Characteristics

**Voltage Ratings** 2,750 V – 38,000 V  
**Current Range** 10E – 600E

## Options

- Hermetically sealed for use in hazardous locations (add "S" suffix to part number)
- Clip-lock (CL) available.

## Dimensions

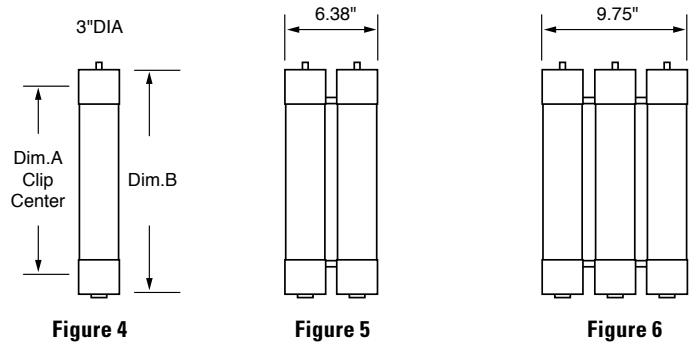

| E-RATED      | ORDERING/CATALOG NUMBER | SIZE | DIM. A (INCHES) | DIM. B (INCHES) | MAX INTERRUPTING RATING RMS (ASYM)* | FIGURE NUMBER |
|--------------|-------------------------|------|-----------------|-----------------|-------------------------------------|---------------|
| 2.75 MAX. KV | 10E1C2.75               | 10E  | 7"              | 10.875"         | 80,000                              | 4             |
|              | 15E1C2.75               | 15E  | 7"              | 10.875"         | 80,000                              | 4             |
|              | 20E1C2.75               | 20E  | 7"              | 10.875"         | 80,000                              | 4             |
|              | 25E1C2.75               | 25E  | 7"              | 10.875"         | 80,000                              | 4             |
|              | 30E1C2.75               | 30E  | 7"              | 10.875"         | 80,000                              | 4             |
|              | 40E1C2.75               | 40E  | 7"              | 10.875"         | 80,000                              | 4             |
|              | 50E1C2.75               | 50E  | 7"              | 10.875"         | 80,000                              | 4             |
|              | 65E1C2.75               | 65E  | 7"              | 10.875"         | 80,000                              | 4             |
|              | 80E1C2.75               | 80E  | 7"              | 10.875"         | 80,000                              | 4             |
|              | 100E-1C2.75             | 100E | 7"              | 10.875"         | 80,000                              | 4             |
|              | 125E1C2.75              | 125E | 7"              | 10.875"         | 80,000                              | 4             |
|              | 150E1C2.75              | 150E | 7"              | 10.875"         | 80,000                              | 4             |
|              | 200E1C2.75              | 200E | 7"              | 10.875"         | 80,000                              | 4             |
|              | 125E2C2.75              | 125E | 7"              | 10.875"         | 80,000                              | 5             |
|              | 150E2C2.75              | 150E | 7"              | 10.875"         | 80,000                              | 5             |
|              | 200E2C2.75              | 200E | 7"              | 10.875"         | 80,000                              | 5             |
|              | 250E2C2.75              | 250E | 7"              | 10.875"         | 80,000                              | 5             |
|              | 300E2C2.75              | 300E | 7"              | 10.875"         | 80,000                              | 5             |
| 350E2C2.75   | 350E                    | 7"   | 10.875"         | 80,000          | 5                                   |               |
| 400E2C2.75   | 400E                    | 7"   | 10.875"         | 80,000          | 5                                   |               |
| 450E2C2.75   | 450E                    | 7"   | 10.875"         | 80,000          | 5                                   |               |

\* RMS Asymmetrical amperes = RMS Symmetrical amperes x 1.6

# E-RATED MEDIUM VOLTAGE FUSES

| E-RATED     | ORDERING/CATALOG NUMBER | SIZE | DIM. A (INCHES) | DIM. B (INCHES) | MAX INTERRUPTING RATING RMS (ASYM)* | FIGURE NUMBER |
|-------------|-------------------------|------|-----------------|-----------------|-------------------------------------|---------------|
| 5.5 MAX. KV | 10E1C5.5                | 10E  | 12"             | 15.875"         | 80,000                              | 4             |
|             | 15E1C5.5                | 15E  | 12"             | 15.875"         | 80,000                              | 4             |
|             | 20E1C5.5                | 20E  | 12"             | 15.875"         | 80,000                              | 4             |
|             | 25E1C5.5                | 25E  | 12"             | 15.875"         | 80,000                              | 4             |
|             | 30E1C5.5                | 30E  | 12"             | 15.875"         | 80,000                              | 4             |
|             | 40E1C5.5                | 40E  | 12"             | 15.875"         | 80,000                              | 4             |
|             | 50E1C5.5                | 50E  | 12"             | 15.875"         | 80,000                              | 4             |
|             | 65E1C5.5                | 65E  | 12"             | 15.875"         | 80,000                              | 4             |
|             | 80E1C5.5                | 80E  | 12"             | 15.875"         | 80,000                              | 4             |
|             | 100E1C5.5               | 100E | 12"             | 15.875"         | 80,000                              | 4             |
|             | 125E1C5.5               | 125E | 12"             | 15.875"         | 80,000                              | 4             |
|             | 150E1C5.5               | 150E | 12"             | 15.875"         | 80,000                              | 4             |
|             | 175E1C5.5               | 175E | 12"             | 15.875"         | 80,000                              | 4             |
|             | 200E1C5.5               | 200E | 12"             | 15.875"         | 80,000                              | 4             |
|             | 125E2C5.5               | 125E | 12"             | 15.875"         | 80,000                              | 5             |
|             | 150E2C5.5               | 150E | 12"             | 15.875"         | 80,000                              | 5             |
|             | 200E2C5.5               | 200E | 12"             | 15.875"         | 80,000                              | 5             |
|             | 250E2C5.5               | 250E | 12"             | 15.875"         | 80,000                              | 5             |
|             | 300E2C5.5               | 300E | 12"             | 15.875"         | 80,000                              | 5             |
|             | 350E2C5.5               | 350E | 12"             | 15.875"         | 80,000                              | 5             |
|             | 400E2C5.5               | 400E | 12"             | 15.875"         | 80,000                              | 5             |
|             | 450E2C5.5               | 450E | 12"             | 15.875"         | 80,000                              | 5             |
|             | 500E3C5.5               | 500E | 12"             | 15.875"         | 80,000                              | 6             |
|             | 550E3C5.5               | 550E | 12"             | 15.875"         | 80,000                              | 6             |
| 600E3C5.5   | 600E                    | 12"  | 15.875"         | 80,000          | 6                                   |               |

| E-RATED     | ORDERING/CATALOG NUMBER | SIZE | DIM. A (INCHES) | DIM. B (INCHES)    | MAX INTERRUPTING RATING RMS (ASYM)* | FIGURE NUMBER |
|-------------|-------------------------|------|-----------------|--------------------|-------------------------------------|---------------|
| 5.5 MAX. KV | 5NLE10E                 | 10E  | 14"             | 17 $\frac{7}{8}$ " | 80,000                              | 4             |
|             | 5NLE15E                 | 15E  | 14"             | 17 $\frac{7}{8}$ " | 80,000                              | 4             |
|             | 5NLE20E                 | 20E  | 14"             | 17 $\frac{7}{8}$ " | 80,000                              | 4             |
|             | 5NLE25E                 | 25E  | 14"             | 17 $\frac{7}{8}$ " | 80,000                              | 4             |
|             | 5NLE30E                 | 30E  | 14"             | 17 $\frac{7}{8}$ " | 80,000                              | 4             |
|             | 5NLE40E                 | 40E  | 14"             | 17 $\frac{7}{8}$ " | 80,000                              | 4             |
|             | 5NLE50E                 | 50E  | 14"             | 17 $\frac{7}{8}$ " | 80,000                              | 4             |
|             | 5NLE65E                 | 65E  | 14"             | 17 $\frac{7}{8}$ " | 80,000                              | 4             |
|             | 5NLE80E                 | 80E  | 14"             | 17 $\frac{7}{8}$ " | 80,000                              | 4             |
|             | 5NLE100E                | 100E | 14"             | 17 $\frac{7}{8}$ " | 80,000                              | 4             |
|             | 5NLE125E                | 125E | 14"             | 17 $\frac{7}{8}$ " | 80,000                              | 4             |
|             | 5NLE150E                | 150E | 14"             | 17 $\frac{7}{8}$ " | 80,000                              | 4             |
|             | 5NLE175E                | 175E | 14"             | 17 $\frac{7}{8}$ " | 80,000                              | 4             |
|             | 5NLE200E                | 200E | 14"             | 17 $\frac{7}{8}$ " | 80,000                              | 4             |
|             | 5NLE2225E               | 225E | 14"             | 17 $\frac{7}{8}$ " | 80,000                              | 5             |
|             | 5NLE2250E               | 250E | 14"             | 17 $\frac{7}{8}$ " | 80,000                              | 5             |
|             | 5NLE2300E               | 300E | 14"             | 17 $\frac{7}{8}$ " | 80,000                              | 5             |
|             | 5NLE2350E               | 350E | 14"             | 17 $\frac{7}{8}$ " | 80,000                              | 5             |
|             | 5NLE2400E               | 400E | 14"             | 17 $\frac{7}{8}$ " | 80,000                              | 5             |
|             | 5NLE2450E               | 450E | 14"             | 17 $\frac{7}{8}$ " | 80,000                              | 5             |

\* RMS Asymmetrical amperes = RMS Symmetrical amperes x 1.6

# E-RATED MEDIUM VOLTAGE FUSES

| E-RATED      | ORDERING/CATALOG NUMBER | SIZE | DIM. A (INCHES)                  | DIM. B (INCHES)                  | MAX INTERRUPTING RATING RMS (ASYM)* | FIGURE NUMBER |
|--------------|-------------------------|------|----------------------------------|----------------------------------|-------------------------------------|---------------|
| 8.25 MAX. KV | 10E1C8.25               | 10E  | 12"                              | 15 <sup>7</sup> / <sub>8</sub> " | 80,000                              | 4             |
|              | 15E1C8.25               | 15E  | 12"                              | 15 <sup>7</sup> / <sub>8</sub> " | 80,000                              | 4             |
|              | 20E1C8.25               | 20E  | 12"                              | 15 <sup>7</sup> / <sub>8</sub> " | 80,000                              | 4             |
|              | 25E1C8.25               | 25E  | 12"                              | 15 <sup>7</sup> / <sub>8</sub> " | 80,000                              | 4             |
|              | 30E1C8.25               | 30E  | 12"                              | 15 <sup>7</sup> / <sub>8</sub> " | 80,000                              | 4             |
|              | 40E1C8.25               | 40E  | 12"                              | 15 <sup>7</sup> / <sub>8</sub> " | 80,000                              | 4             |
|              | 50E1C8.25               | 50E  | 12"                              | 15 <sup>7</sup> / <sub>8</sub> " | 80,000                              | 4             |
|              | 65E1C8.25               | 65E  | 12"                              | 15 <sup>7</sup> / <sub>8</sub> " | 80,000                              | 4             |
|              | 80E1C8.25               | 80E  | 12"                              | 15 <sup>7</sup> / <sub>8</sub> " | 80,000                              | 4             |
|              | 100E1C8.25              | 100E | 12"                              | 15 <sup>7</sup> / <sub>8</sub> " | 80,000                              | 4             |
|              | 125E1C8.25              | 125E | 12"                              | 15 <sup>7</sup> / <sub>8</sub> " | 80,000                              | 4             |
|              | 150E1C8.25              | 150E | 12"                              | 15 <sup>7</sup> / <sub>8</sub> " | 80,000                              | 4             |
|              | 125E2C8.25              | 125E | 12"                              | 15 <sup>7</sup> / <sub>8</sub> " | 80,000                              | 5             |
|              | 150E2C8.25              | 150E | 12"                              | 15 <sup>7</sup> / <sub>8</sub> " | 80,000                              | 5             |
|              | 200E2C8.25              | 200E | 12"                              | 15 <sup>7</sup> / <sub>8</sub> " | 80,000                              | 5             |
|              | 250E2C8.25              | 250E | 12"                              | 15 <sup>7</sup> / <sub>8</sub> " | 80,000                              | 5             |
|              | 300E2C8.25              | 300E | 12"                              | 15 <sup>7</sup> / <sub>8</sub> " | 80,000                              | 5             |
|              | 350E3C8.25              | 350E | 12"                              | 15 <sup>7</sup> / <sub>8</sub> " | 80,000                              | 6             |
| 400E3C8.25   | 400E                    | 12"  | 15 <sup>7</sup> / <sub>8</sub> " | 80,000                           | 6                                   |               |

| E-RATED      | ORDERING/CATALOG NUMBER | SIZE | DIM. A (INCHES)                  | DIM. B (INCHES)                  | MAX INTERRUPTING RATING RMS (ASYM)* | FIGURE NUMBER |
|--------------|-------------------------|------|----------------------------------|----------------------------------|-------------------------------------|---------------|
| 8.25 MAX. KV | 8NLE10E                 | 10E  | 14"                              | 17 <sup>7</sup> / <sub>8</sub> " | 80,000                              | 4             |
|              | 8NLE15E                 | 15E  | 14"                              | 17 <sup>7</sup> / <sub>8</sub> " | 80,000                              | 4             |
|              | 8NLE20E                 | 20E  | 14"                              | 17 <sup>7</sup> / <sub>8</sub> " | 80,000                              | 4             |
|              | 8NLE25E                 | 25E  | 14"                              | 17 <sup>7</sup> / <sub>8</sub> " | 80,000                              | 4             |
|              | 8NLE30E                 | 30E  | 14"                              | 17 <sup>7</sup> / <sub>8</sub> " | 80,000                              | 4             |
|              | 8NLE40E                 | 40E  | 14"                              | 17 <sup>7</sup> / <sub>8</sub> " | 80,000                              | 4             |
|              | 8NLE50E                 | 50E  | 14"                              | 17 <sup>7</sup> / <sub>8</sub> " | 80,000                              | 4             |
|              | 8NLE65E                 | 65E  | 14"                              | 17 <sup>7</sup> / <sub>8</sub> " | 80,000                              | 4             |
|              | 8NLE80E                 | 80E  | 14"                              | 17 <sup>7</sup> / <sub>8</sub> " | 80,000                              | 4             |
|              | 8NLE100E                | 100E | 14"                              | 17 <sup>7</sup> / <sub>8</sub> " | 80,000                              | 4             |
|              | 8NLE2100E               | 100E | 14"                              | 17 <sup>7</sup> / <sub>8</sub> " | 80,000                              | 5             |
|              | 8NLE2125E               | 125E | 14"                              | 17 <sup>7</sup> / <sub>8</sub> " | 80,000                              | 5             |
|              | 8NLE2150E               | 150E | 14"                              | 17 <sup>7</sup> / <sub>8</sub> " | 80,000                              | 5             |
|              | 8NLE2200E               | 200E | 14"                              | 17 <sup>7</sup> / <sub>8</sub> " | 80,000                              | 5             |
| 8NLE2250E    | 250E                    | 14"  | 17 <sup>7</sup> / <sub>8</sub> " | 80,000                           | 5                                   |               |

| E-RATED      | ORDERING/CATALOG NUMBER | SIZE | DIM. A (INCHES) | DIM. B (INCHES) | MAX INTERRUPTING RATING RMS (ASYM)* | FIGURE NUMBER |
|--------------|-------------------------|------|-----------------|-----------------|-------------------------------------|---------------|
| 15.5 MAX. KV | 10E1C15.5               | 10E  | 15"             | 18.875"         | 80,000                              | 4             |
|              | 15E1C15.5               | 15E  | 15"             | 18.875"         | 80,000                              | 4             |
|              | 20E1C15.5               | 20E  | 15"             | 18.875"         | 80,000                              | 4             |
|              | 25E1C15.5               | 25E  | 15"             | 18.875"         | 80,000                              | 4             |
|              | 30E1C15.5               | 30E  | 15"             | 18.875"         | 80,000                              | 4             |
|              | 40E1C15.5               | 40E  | 15"             | 18.875"         | 80,000                              | 4             |
|              | 50E1C15.5               | 50E  | 15"             | 18.875"         | 80,000                              | 4             |
|              | 65E1C15.5               | 65E  | 15"             | 18.875"         | 80,000                              | 4             |
|              | 80E1C15.5               | 80E  | 15"             | 18.875"         | 80,000                              | 4             |
|              | 100E1C15.5              | 100E | 15"             | 18.875"         | 80,000                              | 4             |
|              | 65E2C15.5               | 65E  | 15"             | 18.875"         | 80,000                              | 5             |
|              | 80E2C15.5               | 80E  | 15"             | 18.875"         | 80,000                              | 5             |
|              | 100E2C15.5              | 100E | 15"             | 18.875"         | 80,000                              | 5             |
|              | 125E2C15.5              | 125E | 15"             | 18.875"         | 80,000                              | 5             |
|              | 150E2C15.5              | 150E | 15"             | 18.875"         | 80,000                              | 5             |
|              | 175E2C15.5              | 175E | 15"             | 18.875"         | 80,000                              | 5             |
|              | 200E2C15.5              | 200E | 15"             | 18.875"         | 80,000                              | 5             |
|              | 200E3C15.5              | 200E | 15"             | 18.875"         | 80,000                              | 6             |
|              | 250E3C15.5              | 250E | 15"             | 18.875"         | 80,000                              | 6             |
|              | 300E3C15.5              | 300E | 15"             | 18.875"         | 80,000                              | 6             |

\* RMS Asymmetrical amperes = RMS Symmetrical amperes x 1.6

# E-RATED MEDIUM VOLTAGE FUSES

| E-RATED      | ORDERING/CATALOG NUMBER | SIZE | DIM. A (INCHES) | DIM. B (INCHES)                  | MAX INTERRUPTING RATING RMS (ASYM)* | FIGURE NUMBER |
|--------------|-------------------------|------|-----------------|----------------------------------|-------------------------------------|---------------|
| 15.5 MAX. KV | 15GSE65E                | 65E  | 18"             | 21 <sup>7</sup> / <sub>8</sub> " | 60,000                              | 4             |
|              | 15GSE80E                | 80E  | 18"             | 21 <sup>7</sup> / <sub>8</sub> " | 60,000                              | 4             |
|              | 15GSE100E               | 100E | 18"             | 21 <sup>7</sup> / <sub>8</sub> " | 60,000                              | 4             |
|              | 15GSE2125E              | 125E | 18"             | 21 <sup>7</sup> / <sub>8</sub> " | 60,000                              | 5             |
|              | 15GSE2150E              | 150E | 18"             | 21 <sup>7</sup> / <sub>8</sub> " | 60,000                              | 5             |
|              | 15GSE2175E              | 175E | 18"             | 21 <sup>7</sup> / <sub>8</sub> " | 60,000                              | 5             |
|              | 15GSE2200E              | 200E | 18"             | 21 <sup>7</sup> / <sub>8</sub> " | 60,000                              | 5             |

| E-RATED      | ORDERING/CATALOG NUMBER | SIZE | DIM. A (INCHES)                  | DIM. B (INCHES)                  | MAX INTERRUPTING RATING RMS (ASYM)* | FIGURE NUMBER |
|--------------|-------------------------|------|----------------------------------|----------------------------------|-------------------------------------|---------------|
| 15.5 MAX. KV | 15NLE10E                | 10E  | 20"                              | 23 <sup>7</sup> / <sub>8</sub> " | 60,000                              | 4             |
|              | 15NLE15E                | 15E  | 20"                              | 23 <sup>7</sup> / <sub>8</sub> " | 60,000                              | 4             |
|              | 15NLE20E                | 20E  | 20"                              | 23 <sup>7</sup> / <sub>8</sub> " | 60,000                              | 4             |
|              | 15NLE25E                | 25E  | 20"                              | 23 <sup>7</sup> / <sub>8</sub> " | 60,000                              | 4             |
|              | 15NLE30E                | 30E  | 20"                              | 23 <sup>7</sup> / <sub>8</sub> " | 60,000                              | 4             |
|              | 15NLE40E                | 40E  | 20"                              | 23 <sup>7</sup> / <sub>8</sub> " | 60,000                              | 4             |
|              | 15NLE50E                | 50E  | 20"                              | 23 <sup>7</sup> / <sub>8</sub> " | 60,000                              | 4             |
|              | 15NLE65E                | 65E  | 20"                              | 23 <sup>7</sup> / <sub>8</sub> " | 60,000                              | 4             |
|              | 15NLE80E                | 80E  | 20"                              | 23 <sup>7</sup> / <sub>8</sub> " | 60,000                              | 4             |
|              | 15NLE100E               | 100E | 20"                              | 23 <sup>7</sup> / <sub>8</sub> " | 60,000                              | 4             |
|              | 15NLE280E               | 80E  | 20"                              | 23 <sup>7</sup> / <sub>8</sub> " | 60,000                              | 5             |
|              | 15NLE2100E              | 100E | 20"                              | 23 <sup>7</sup> / <sub>8</sub> " | 60,000                              | 5             |
|              | 15NLE2125E              | 125E | 20"                              | 23 <sup>7</sup> / <sub>8</sub> " | 60,000                              | 5             |
|              | 15NLE2150E              | 150E | 20"                              | 23 <sup>7</sup> / <sub>8</sub> " | 60,000                              | 5             |
|              | 15NLE2175E              | 175E | 20"                              | 23 <sup>7</sup> / <sub>8</sub> " | 60,000                              | 5             |
|              | 15NLE2200E              | 200E | 20"                              | 23 <sup>7</sup> / <sub>8</sub> " | 60,000                              | 5             |
|              | 15NLE3150E              | 150E | 20"                              | 23 <sup>7</sup> / <sub>8</sub> " | 60,000                              | 6             |
|              | 15NLE3175E              | 175E | 20"                              | 23 <sup>7</sup> / <sub>8</sub> " | 60,000                              | 6             |
| 15NLE3250E   | 250E                    | 20"  | 23 <sup>7</sup> / <sub>8</sub> " | 60,000                           | 6                                   |               |
| 15NLE3300E   | 300E                    | 20"  | 23 <sup>7</sup> / <sub>8</sub> " | 60,000                           | 6                                   |               |

| E-RATED      | ORDERING/CATALOG NUMBER | SIZE | DIM. A (INCHES) | DIM. B (INCHES)                  | MAX INTERRUPTING RATING RMS (ASYM)* | FIGURE NUMBER |
|--------------|-------------------------|------|-----------------|----------------------------------|-------------------------------------|---------------|
| 25.8 MAX. KV | 15E1C25.8               | 15E  | 21"             | 24 <sup>7</sup> / <sub>8</sub> " | 40,000                              | 4             |
|              | 20E1C25.8               | 20E  | 21"             | 24 <sup>7</sup> / <sub>8</sub> " | 40,000                              | 4             |
|              | 25E1C25.8               | 25E  | 21"             | 24 <sup>7</sup> / <sub>8</sub> " | 40,000                              | 4             |
|              | 30E1C25.8               | 30E  | 21"             | 24 <sup>7</sup> / <sub>8</sub> " | 40,000                              | 4             |
|              | 40E1C25.8               | 40E  | 21"             | 24 <sup>7</sup> / <sub>8</sub> " | 40,000                              | 4             |
|              | 50E1C25.8               | 50E  | 21"             | 24 <sup>7</sup> / <sub>8</sub> " | 40,000                              | 4             |
|              | 65E2C25.8               | 65E  | 21"             | 24 <sup>7</sup> / <sub>8</sub> " | 40,000                              | 5             |
|              | 80E2C25.8               | 80E  | 21"             | 24 <sup>7</sup> / <sub>8</sub> " | 40,000                              | 5             |
|              | 100E2C25.8              | 100E | 21"             | 24 <sup>7</sup> / <sub>8</sub> " | 40,000                              | 5             |

| E-RATED    | ORDERING/CATALOG NUMBER | SIZE | DIM. A (INCHES) | DIM. B (INCHES)                  | MAX INTERRUPTING RATING RMS (ASYM)* | FIGURE NUMBER |
|------------|-------------------------|------|-----------------|----------------------------------|-------------------------------------|---------------|
| 38 MAX. KV | 3E1C38.0                | 3E   | 27"             | 30 <sup>7</sup> / <sub>8</sub> " | 20,000                              | 4             |
|            | 7E1C38.0                | 7E   | 27"             | 30 <sup>7</sup> / <sub>8</sub> " | 20,000                              | 4             |
|            | 10E1C38.0               | 10E  | 27"             | 30 <sup>7</sup> / <sub>8</sub> " | 20,000                              | 4             |
|            | 15E1C38.0               | 15E  | 27"             | 30 <sup>7</sup> / <sub>8</sub> " | 20,000                              | 4             |
|            | 20E1C38.0               | 20E  | 27"             | 30 <sup>7</sup> / <sub>8</sub> " | 20,000                              | 4             |
|            | 25E1C38.0               | 25E  | 27"             | 30 <sup>7</sup> / <sub>8</sub> " | 20,000                              | 4             |
|            | 30E1C38.0               | 30E  | 27"             | 30 <sup>7</sup> / <sub>8</sub> " | 20,000                              | 4             |
|            | 40E1C38.0               | 40E  | 27"             | 30 <sup>7</sup> / <sub>8</sub> " | 20,000                              | 4             |
|            | 50E2C38.0               | 50E  | 27"             | 30 <sup>7</sup> / <sub>8</sub> " | 20,000                              | 5             |
|            | 65E2C38.0               | 65E  | 27"             | 30 <sup>7</sup> / <sub>8</sub> " | 20,000                              | 5             |
|            | 80E2C38.0               | 80E  | 27"             | 30 <sup>7</sup> / <sub>8</sub> " | 20,000                              | 5             |

\* RMS Asymmetrical amperes = RMS Symmetrical amperes x 1.6

# E-RATED MEDIUM VOLTAGE FUSES

## Clip Lock Design

The clip lock type designs ensures a positive contact between the fuse and the connection cam. The fuse's clip lock tab slides in between the clip casting and the cam to prevent the fuse from slipping or blowing out of the holder. This positive contact improves heat dissipation and allows fuses to run cooler.

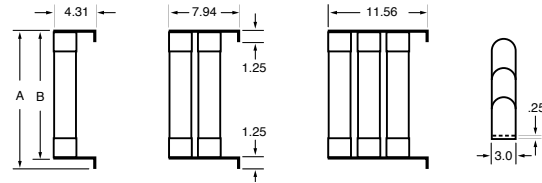

Figure 7

Figure 8

Figure 9

Dimensions in inches

| E-RATED                   | ORDERING/CATALOG NUMBER   | SIZE       | DIM. A (INCHES) | DIM. B (INCHES) | MAX INTERRUPTING RATING RMS (ASYM)* | FIGURE NUMBER |   |
|---------------------------|---------------------------|------------|-----------------|-----------------|-------------------------------------|---------------|---|
| 5.5 MAX. KV<br>CLIP LOCK  | 10E1CL5.5                 | 10E        | 16.38"          | 15.13"          | 80,000                              | 7             |   |
|                           | 15E1CL5.5                 | 15E        | 16.38"          | 15.13"          | 80,000                              | 7             |   |
|                           | 20E1CL5.5                 | 20E        | 16.38"          | 15.13"          | 80,000                              | 7             |   |
|                           | 25E1CL5.5                 | 25E        | 16.38"          | 15.13"          | 80,000                              | 7             |   |
|                           | 30E1CL5.5                 | 30E        | 16.38"          | 15.13"          | 80,000                              | 7             |   |
|                           | 40E1CL5.5                 | 40E        | 16.38"          | 15.13"          | 80,000                              | 7             |   |
|                           | 50E1CL5.5                 | 50E        | 16.38"          | 15.13"          | 80,000                              | 7             |   |
|                           | 65E1CL5.5                 | 65E        | 16.38"          | 15.13"          | 80,000                              | 7             |   |
|                           | 80E1CL5.5                 | 80E        | 16.38"          | 15.13"          | 80,000                              | 7             |   |
|                           | 100E1CL5.5                | 100E       | 16.38"          | 15.13"          | 80,000                              | 7             |   |
|                           | 125E1CL5.5                | 125E       | 16.38"          | 15.13"          | 80,000                              | 7             |   |
|                           | 150E1CL5.5                | 150E       | 16.38"          | 15.13"          | 80,000                              | 7             |   |
|                           | 225E2CL5.5                | 225E       | 17.38"          | 16.13"          | 80,000                              | 8             |   |
|                           | 250E2CL5.5                | 250E       | 17.38"          | 16.13"          | 80,000                              | 8             |   |
|                           | 300E2CL5.5                | 300E       | 17.38"          | 16.13"          | 80,000                              | 8             |   |
|                           | 350E2CL5.5                | 350E       | 17.38"          | 16.13"          | 80,000                              | 8             |   |
|                           | 400E2CL5.5                | 400E       | 17.38"          | 16.13"          | 80,000                              | 8             |   |
|                           | 450E2CL5.5                | 450E       | 17.38"          | 16.13"          | 80,000                              | 8             |   |
|                           | 500E3CL5.5                | 500E       | 17.38"          | 16.13"          | 80,000                              | 9             |   |
|                           | 550E3CL5.5                | 550E       | 17.38"          | 16.13"          | 80,000                              | 9             |   |
| 600E3CL5.5                | 600E                      | 17.38"     | 16.13"          | 80,000          | 9                                   |               |   |
| 8.25 MAX. KV<br>CLIP LOCK | 10E1CL8.25                | 10E        | 17.38"          | 16.13"          | 80,000                              | 7             |   |
|                           | 15E1CL8.25                | 15E        | 17.38"          | 16.13"          | 80,000                              | 7             |   |
|                           | 20E1CL8.25                | 20E        | 17.38"          | 16.13"          | 80,000                              | 7             |   |
|                           | 25E1CL8.25                | 25E        | 17.38"          | 16.13"          | 80,000                              | 7             |   |
|                           | 30E1CL8.25                | 30E        | 17.38"          | 16.13"          | 80,000                              | 7             |   |
|                           | 40E1CL8.25                | 40E        | 17.38"          | 16.13"          | 80,000                              | 7             |   |
|                           | 50E1CL8.25                | 50E        | 17.38"          | 16.13"          | 80,000                              | 7             |   |
|                           | 65E1CL8.25                | 65E        | 17.38"          | 16.13"          | 80,000                              | 7             |   |
|                           | 80E1CL8.25                | 80E        | 17.38"          | 16.13"          | 80,000                              | 7             |   |
|                           | 100E1CL8.25               | 100E       | 17.38"          | 16.13"          | 80,000                              | 7             |   |
|                           | 125E2CL8.25               | 125E       | 17.38"          | 16.13"          | 80,000                              | 8             |   |
|                           | 150E2CL8.25               | 150E       | 17.38"          | 16.13"          | 80,000                              | 8             |   |
|                           | 175E2CL8.25               | 175E       | 17.38"          | 16.13"          | 80,000                              | 8             |   |
|                           | 200E2CL8.25               | 200E       | 17.38"          | 16.13"          | 80,000                              | 8             |   |
|                           | 225E2CL8.25               | 225E       | 17.38"          | 16.13"          | 80,000                              | 8             |   |
|                           | 250E2CL8.25               | 250E       | 17.38"          | 16.13"          | 80,000                              | 8             |   |
|                           | 300E2CL8.25               | 300E       | 17.38"          | 16.13"          | 80,000                              | 8             |   |
|                           | 350E3CL8.25               | 350E       | 17.38"          | 16.13"          | 80,000                              | 9             |   |
|                           | 15.5 MAX. KV<br>CLIP LOCK | 10E1CL15.5 | 10E             | 19.8"           | 18.1"                               | 60,000        | 7 |
|                           |                           | 15E1CL15.5 | 15E             | 19.8"           | 18.1"                               | 60,000        | 7 |
| 20E1CL15.5                |                           | 20E        | 19.8"           | 18.1"           | 60,000                              | 7             |   |
| 25E1CL15.5                |                           | 25E        | 19.8"           | 18.1"           | 60,000                              | 7             |   |
| 30E1CL15.5                |                           | 30E        | 19.8"           | 18.1"           | 60,000                              | 7             |   |
| 40E1CL15.5                |                           | 40E        | 19.8"           | 18.1"           | 60,000                              | 7             |   |
| 50E1CL15.5                |                           | 50E        | 19.8"           | 18.1"           | 60,000                              | 7             |   |
| 65E1CL15.5                |                           | 65E        | 22.81"          | 21.13"          | 60,000                              | 7             |   |
| 80E1CL15.5                |                           | 80E        | 22.81"          | 21.13"          | 60,000                              | 7             |   |
| 100E1CL15.5               |                           | 100E       | 22.81"          | 21.13"          | 60,000                              | 7             |   |
| 125E2CL15.5               |                           | 125E       | 22.81"          | 21.13"          | 60,000                              | 8             |   |
| 150E2CL15.5               |                           | 150E       | 22.81"          | 21.13"          | 60,000                              | 8             |   |
| 175E2CL15.5               |                           | 175E       | 22.81"          | 21.13"          | 60,000                              | 8             |   |
| 200E2CL15.5               |                           | 200E       | 22.81"          | 21.13"          | 60,000                              | 8             |   |
| 150E3CL15.5               |                           | 150E       | 22.81"          | 21.13"          | 60,000                              | 9             |   |
| 200E3CL15.5               |                           | 200E       | 22.81"          | 21.13"          | 60,000                              | 9             |   |
| 250E3CL15.5               |                           | 250E       | 22.81"          | 21.13"          | 60,000                              | 9             |   |
| 300E3CL15.5               |                           | 300E       | 22.81"          | 21.13"          | 60,000                              | 9             |   |

\* RMS Asymmetrical amperes = RMS Symmetrical amperes x 1.6



# E-RATED POTENTIAL TRANSFORMER FUSES

## Description

Potential Transformer (PT) fuses are current-limiting fuses with high interrupting ratings designed for the protection of potential transformers.

## Application Note

When applying fuses for the protection of transformers, the magnetizing current in-rush must be considered. The characteristics of the in-rush, which can be matched with a fuse time-current curve, should be available from the transformer manufacturer.

## Characteristics

**Voltage Ratings** 625 Vac – 25,800 Vac  
**Current Range** ½E – 10E

## Dimensions

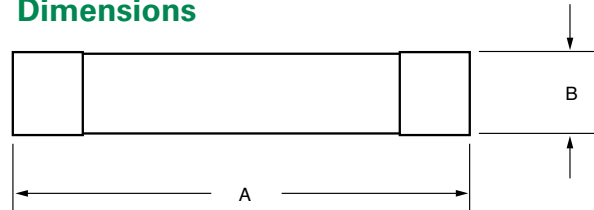

| E-RATED      | ORDERING/CATALOG NUMBER | SIZE | LENGTH DIM. A (INCHES) | DIAMETER DIM. B (INCHES) | MAX INTERRUPTING RATING RMS (ASYM)* |
|--------------|-------------------------|------|------------------------|--------------------------|-------------------------------------|
| 625 VOLT     | 3E4PT.6                 | 3E   | 4.6"                   | 0.8125"                  | 37,500                              |
|              | 5E4PT.6                 | 5E   | 4.6"                   | 0.8125"                  | 37,500                              |
|              | 7E4PT.6                 | 7E   | 4.6"                   | 0.8125"                  | 37,500                              |
|              | 10E4PT.6                | 10E  | 4.6"                   | 0.8125"                  | 37,500                              |
| 2.75 MAX. KV | 500E4PT2.4              | ½E   | 4.6"                   | 0.8125"                  | 37,500                              |
|              | 1E4PT2.4                | 1E   | 4.6"                   | 0.8125"                  | 37,500                              |
|              | 2E4PT2.4                | 2E   | 4.6"                   | 0.8125"                  | 37,500                              |
| 2.75 MAX. KV | 1E6PT2.75               | 1E   | 7.4"                   | 1.5625"                  | 37,500                              |
|              | 2E6PT2.75               | 2E   | 7.4"                   | 1.5625"                  | 37,500                              |
|              | 3E6PT2.75               | 3E   | 7.4"                   | 1.5625"                  | 37,500                              |
|              | 1E8PT2.75               | 1E   | 9.5"                   | 1.5625"                  | 37,500                              |
|              | 2E8PT2.75               | 2E   | 9.5"                   | 1.5625"                  | 37,500                              |
|              | 3E8PT2.75               | 3E   | 9.5"                   | 1.5625"                  | 37,500                              |
| 4.8 MAX. KV  | 1E5PT4.8                | 1E   | 5.6"                   | 0.8125"                  | 50,000                              |
|              | 2E5PT4.8                | 2E   | 5.6"                   | 0.8125"                  | 50,000                              |
| 5.5 MAX. KV  | 500E6PT5.5              | ½E   | 7.4"                   | 1.5625"                  | 50,000                              |
|              | 1E6PT5.5                | 1E   | 7.4"                   | 1.5625"                  | 50,000                              |
|              | 2E6PT5.5                | 2E   | 7.4"                   | 1.5625"                  | 50,000                              |
|              | 3E6PT5.5                | 3E   | 7.4"                   | 1.5625"                  | 50,000                              |
|              | 5E6PT5.5                | 5E   | 7.4"                   | 1.5625"                  | 50,000                              |
|              | 500E8PT5.5              | ½E   | 9.5"                   | 1.5625"                  | 50,000                              |
|              | 1E8PT5.5                | 1E   | 9.5"                   | 1.5625"                  | 50,000                              |
|              | 2E8PT5.5                | 2E   | 9.5"                   | 1.5625"                  | 50,000                              |
|              | 3E8PT5.5                | 3E   | 9.5"                   | 1.5625"                  | 50,000                              |
|              | 5E8PT5.5                | 5E   | 9.5"                   | 1.5625"                  | 50,000                              |
| 8.25 MAX. KV | 10E8PT5.5               | 10E  | 9.5"                   | 1.5625"                  | 50,000                              |
|              | 500E8PT8.25             | ½E   | 9.5"                   | 1.5625"                  | 50,000                              |
|              | 1E8PT8.25               | 1E   | 9.5"                   | 1.5625"                  | 50,000                              |
|              | 2E8PT8.25               | 2E   | 9.5"                   | 1.5625"                  | 50,000                              |
| 15.5 MAX. KV | 3E8PT8.25               | 3    | 9.5"                   | 1.5625"                  | 50,000                              |
|              | 500E11PT15.5            | ½E   | 12.8"                  | 1.5625"                  | 35,000                              |
|              | 1E11PT15.5              | 1E   | 12.8"                  | 1.5625"                  | 35,000                              |
|              | 2E11PT15.5              | 2E   | 12.8"                  | 1.5625"                  | 35,000                              |
|              | 3E11PT15.5              | 3E   | 12.8"                  | 1.5625"                  | 35,000                              |
|              | 3E16PT15.5              | 3E   | 17.5"                  | 1.5625"                  | 35,000                              |
| 25.8 MAX. KV | 5E16PT15.5              | 5E   | 17.5"                  | 1.5625"                  | 35,000                              |
|              | 500E16PT25.5            | ½E   | 17.5"                  | 1.5625"                  | 32,000                              |
|              | 1E16PT25.5              | 1E   | 17.5"                  | 1.5625"                  | 32,000                              |

\* RMS Asymmetrical amperes = RMS Symmetrical amperes x 1.6

**Disclaimer Notice** – Information furnished is believed to be accurate and reliable. However, users should independently evaluate the suitability of and test each product selected for their own applications. Littelfuse products are not designed for, and may not be used in, all applications. Read complete Disclaimer Notice at [www.littelfuse.com/product-disclaimer](http://www.littelfuse.com/product-disclaimer).

# LIVE PARTS



## Description

Live parts are available for mounting E, R, and PT single, double, and triple barrel fuses. Mounting clips are available for ferrule type fuses. All clips are sold in pairs.

### Part Number 700-156 Ordering Number 0700156.Z

For use with 1<sup>9</sup>/<sub>16</sub>" (1.5625") to 1<sup>5</sup>/<sub>8</sub>" (1.625") diameter PT fuses.

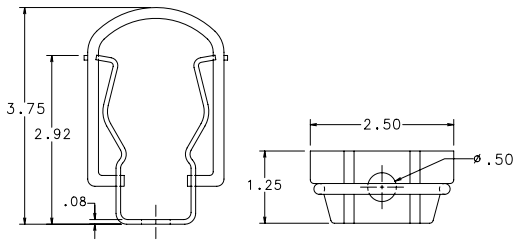

Dimensions in inches

### Part Number 700-300 Ordering Number 0700300.Z

For use with 3" diameter fuses.

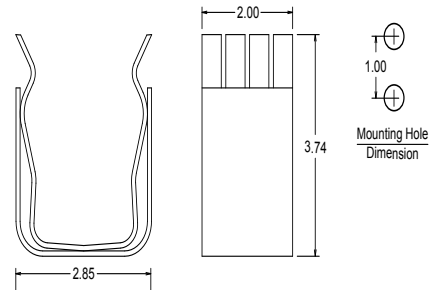

### Part Number 700-500 Ordering Number 0700500.Z

For use with all 1<sup>3</sup>/<sub>16</sub>" (.8125") diameter PT fuses

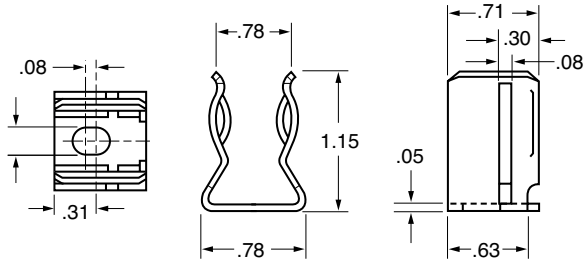

Dimensions in inches

### Part Number 700-530 Ordering Number 0700530.Z

For use with all 3" diameter fuses.

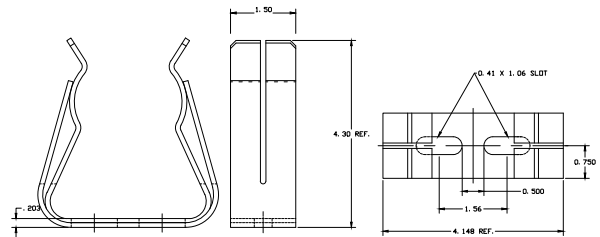

**Disclaimer Notice** – Information furnished is believed to be accurate and reliable. However, users should independently evaluate the suitability of and test each product selected for their own applications. Littelfuse products are not designed for, and may not be used in, all applications. Read complete Disclaimer Notice at [www.littelfuse.com/product-disclaimer](http://www.littelfuse.com/product-disclaimer).