

# AHRF

## Radial Leaded



### Description

The AHRF Series is a PPTC resettable device designed specifically for the automotive industry. It is a 16V high-temperature, lead-free, radial leaded resettable device that meets Littelfuse's Automotive qualification. This qualification is based on AEC-Q200: Stress Test Qualification for Passive Components.

### Features & Benefits

- Overcurrent and overvoltage circuit protection devices
- Resettable and single-use overcurrent devices
- Wide range of form factor and termination methods
- Products meet applicable automotive industry standards
- Devices compatible with high-volume electronics assembly
- RoHS compliant, Lead-Free and Halogen-Free

### Additional Information



Resources



Accessories



Samples

### Applications

- Motor and motor circuit protection including power door-locks, mirrors, lumbar pumps, seats, sunroofs and windows
- Electronic Control Unit (ECU) I/O protection
- Heating, Ventilation and Cooling (HVAC) motor and I/O protection
- Telematics, infotainment and navigations systems
- Liquid Crystal Display (LCD) back-light heaters
- Power and cigarette lighter outlets, plugs and adapter/chargers
- Powered networks and buses
- Air-flow detection and overcurrent protection in HVAC and cooling fan systems
- Stall detection in express window and sunroof circuits
- Resettable overcurrent protection for power distribution, electrical centers and junction boxes
- Wire downsizing
- Motor electromagnetic interference (EMI) suppression
- Electrostatic discharge (ESD) damage protection
- Load dump and other transient voltage protection

### Electrical Characteristics

Part Number	Ordering Part Number	$I_H(A)@$ $(R_{1MAX})$	$I_T(A)@$ $(R_{3MAX})$	$I_T$ $(A)$	$V_{MAX}$ $(V_{DC})$	$I_{MAX}$ $(A)$	$P_{D Typ}$ $(W)$	Max Time-to-trip $(A)$ $(s)$		$R_{MIN}$ $(\Omega)$	$R_{MAX}$ $(\Omega)$	$R_{1MAX}$ $(\Omega)$	Lead Size $(mm^2/AWG)$
<b>AHRF (High Temperature) – 30V</b>													
AHRF050	RF3328-000	0.5	0.5	1.0	30	40	0.9	2.5	3.0	0.3500	1.100	1.100	0.205/24
AHRF070	RF3329-000	0.7	0.7	1.4	30	40	1.4	3.5	3.2	0.2300	0.800	0.800	0.205/24
AHRF100	RF3331-000	1.0	1.0	1.9	30	40	1.4	5.0	6.2	0.1500	0.430	0.430	0.205/24

#### Notes:

- $I_H$  : Hold current: maximum current device will pass without interruption in 25°C, unless otherwise specified.
- $I_T$  : Trip current: minimum current that will switch the device from low-resistance to high-resistance in 25°C still air, unless otherwise specified.
- $V_{MAX}$  : Maximum voltage device can withstand without damage at rated current.
- $I_{MAX}$  : Maximum fault current device can withstand without damage at rated voltage.
- $P_D$  : Power dissipated from device when in the tripped state in 25°C still air, unless otherwise specified.
- $R_{MIN}$  : Minimum resistance of device as supplied at 25°C, unless otherwise specified.
- $R_{1MAX}$  : Maximum resistance of device when measured one hour post trip at 25°C unless otherwise specified.
- $R_{3MAX}$  : Maximum functional resistance of device after being subjected to the stresses described in AEC-Q200 at 25°C, unless otherwise specified.
- $R_{MIN}$  : Minimum functional resistance of device after being subjected to the stresses described in AEC-Q200 at 25°C, unless otherwise specified.

\* Electrical characteristics determined at 25°C.

# AHRF

## Radial Leaded

### Electrical Characteristics (Cont'd)

Part Number	Ordering Part Number	$I_H(A)@$	$I_T(A)@$	$I_T$	$V_{MAX}$	$I_{MAX}$	$P_{D Typ}$	Max Time-to-trip		$R_{MIN}$	$R_{MAX}$	$R_{1MAX}$	Lead Size (mm <sup>2</sup> /AWG)
		( $R_{1MAX}$ )	( $R_{nMAX}$ )					(A)	(V <sub>DC</sub> )				
<b>AHRF (High Temperature) – 16V</b>													
AHRF200	RF3056-000	2.0	2.0	3.8	16	100	1.4	10.0	4.8	0.0390	0.1100	0.1100	0.205/24
AHRF300	RF3334-000	3.0	3.0	6.5	16	100	3.0	15.0	5.0	0.0290	0.0790	0.0790	0.52/20
AHRF400	RF3335-000	4.0	4.0	7.4	16	100	3.3	20.0	5.0	0.0210	0.0600	0.0600	0.52/20
AHRF450	RF3196-000	4.5	4.5	8.7	16	100	3.6	22.5	4.0	0.0170	0.0540	0.0540	0.52/20
AHRF550	RF3338-000	5.5	5.5	10.0	16	100	3.5	27.5	6.0	0.0130	0.0370	0.0370	0.52/20
AHRF600	RF3339-000	6.0	6.0	12.0	16	100	4.1	30.0	6.5	0.0100	0.0320	0.0320	0.52/20
AHRF650	RF3343-000	6.5	6.5	13.7	16	100	4.3	32.5	7.0	0.0090	0.0260	0.0260	0.52/20
AHRF700	RF3345-000	7.0	7.0	13.1	16	100	4.0	35.0	7.0	0.0087	0.0250	0.0250	0.52/20
AHRF750	RF3198-000	7.5	7.5	14.8	16	100	4.5	37.5	8.0	0.0074	0.0220	0.0220	0.52/20
AHRF800	RF3347-000	8.0	8.0	15.0	16	100	4.2	40.0	8.0	0.0072	0.0200	0.0200	0.52/20
AHRF900	RF3348-000	9.0	9.0	18.5	16	100	5.0	45.0	11.5	0.0061	0.0170	0.0170	0.52/20
AHRF1000	RF3349-000	10.0	10.0	20.5	16	100	5.3	50.0	10.5	0.0051	0.0150	0.0150	0.52/20
AHRF1100	RF3351-000	11.0	11.0	21.2	16	100	5.5	55.0	11.0	0.0048	0.0130	0.0130	0.52/20
AHRF1300	RF3193-000	13.0	13.0	27.0	16	100	6.9	65.0	15.0	0.0034	0.0100	0.0100	0.82/18
AHRF1400	RF3353-000	14.0	14.0	28.3	16	100	6.9	70.0	15.5	0.0029	0.0090	0.0090	0.82/18
AHRF1500	RF3354-000	15.0	15.0	33.0	16	100	7.0	75.0	20.0	0.0027	0.0092	0.0092	0.82/18

**Notes:**

- $I_H$  : Hold current: maximum current device will pass without interruption in 25°C, unless otherwise specified.
- $I_T$  : Trip current: minimum current that will switch the device from low-resistance to high-resistance in 25°C still air, unless otherwise specified.
- $V_{MAX}$  : Maximum voltage device can withstand without damage at rated current.
- $I_{MAX}$  : Maximum fault current device can withstand without damage at rated voltage.
- $P_D$  : Power dissipated from device when in the tripped state in 25°C still air, unless otherwise specified.
- $R_{MIN}$  : Minimum resistance of device as supplied at 25°C, unless otherwise specified.
- $R_{1MAX}$  : Maximum resistance of device when measured one hour post trip at 25°C unless otherwise specified.
- $R_{MAX}$  : Maximum functional resistance of device after being subjected to the stresses described in PS400 at 25°C, unless otherwise specified.
- $R_{nMIN}$  : Minimum functional resistance of device after being subjected to the stresses described in PS400 at 25°C, unless otherwise specified.

\* Electrical characteristics determined at 25°C.

### Typical Time-to-Trip Curves at 25°C

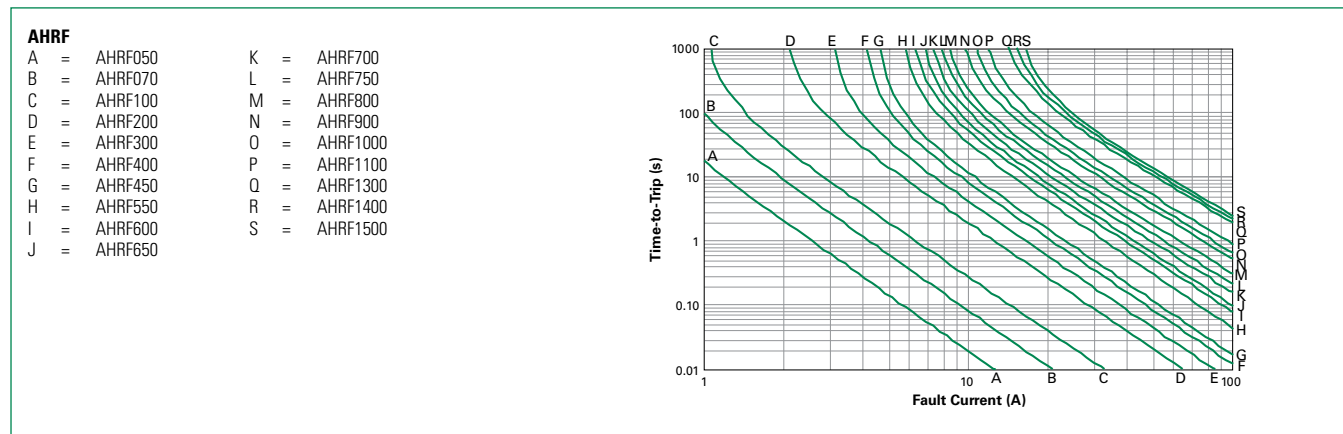

# AHRF

## Radial Leaded

### Temperature Derating

Maximum Ambient Temperature											
	-40°C	-20°C	0°C	20°C	25°C	40°C	50°C	60°C	70°C	85°C	125°C
Hold Current (A)											
AHRF (High Temperature) – 30V											
AHRF050	0.7	0.6	0.6	0.5	0.5	0.4	0.4	0.4	0.3	0.3	0.1
AHRF070	1.0	0.9	0.8	0.7	0.7	0.6	0.6	0.5	0.5	0.4	0.2
AHRF100	1.4	1.2	1.1	1.0	1.0	0.9	0.8	0.7	0.7	0.6	0.2
AHRF (High Temperature) – 16V											
AHRF200	2.7	2.5	2.3	2.1	2.0	1.8	1.6	1.5	1.3	1.1	0.5
AHRF300	4.1	3.7	3.4	3.1	3.0	2.7	2.4	2.2	2.0	1.7	0.7
AHRF400	5.6	5.1	4.7	4.2	4.0	3.6	3.3	3.0	2.7	2.3	1.0
AHRF450	6.1	5.6	5.1	4.6	4.5	4.0	3.6	3.3	3.0	2.5	1.1
AHRF550	7.5	6.9	6.2	5.7	5.5	4.9	4.4	4.0	3.7	3.1	1.4
AHRF600	8.2	7.5	6.8	6.2	6.0	5.3	4.9	4.4	4.0	3.3	1.5
AHRF650	8.8	8.1	7.4	6.7	6.5	5.7	5.3	4.8	4.3	3.6	1.6
AHRF700	9.5	8.7	8.0	7.2	7.0	6.2	5.6	5.2	4.7	3.9	1.7
AHRF750	10.2	9.4	8.6	7.7	7.5	6.6	6.1	5.6	5.0	4.1	1.9
AHRF800	10.9	10.0	9.1	8.2	8.0	7.1	6.4	5.9	5.3	4.4	2.0
AHRF900	12.2	11.2	10.2	9.3	9.0	8.0	7.2	6.6	6.0	5.0	2.2
AHRF1000	13.6	12.5	11.4	10.3	10.0	8.8	8.1	7.4	6.6	5.5	2.5
AHRF1100	14.9	13.7	12.5	11.3	11.0	9.7	8.8	8.1	7.3	6.1	2.7
AHRF1300	17.7	16.3	14.8	13.4	13.0	11.4	10.5	9.6	8.6	7.2	3.3
AHRF1400	19.0	17.5	15.9	14.4	14.0	12.4	11.2	10.3	9.3	7.8	3.5
AHRF1500	20.4	18.8	17.1	15.5	15.0	13.2	12.1	11.1	9.9	8.3	3.8

### Temperature Derating Curve

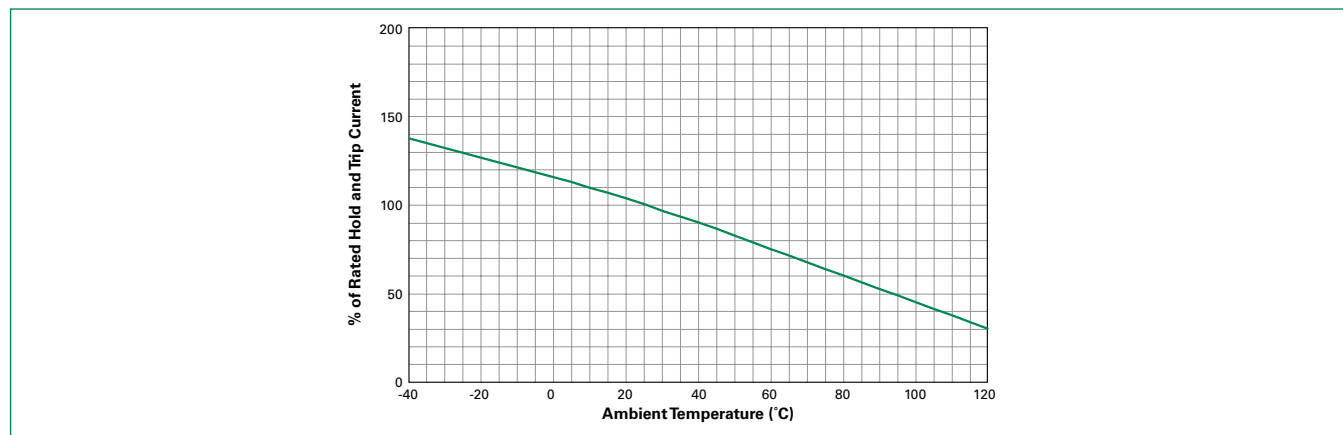

# AHRF

## Radial Leaded

### Physical Specifications

<b>Lead Material</b>	AHRF050 to AHRF200 : Tin-plated Copper-clad Steel, 0.205mm <sup>2</sup> (24 AWG), ø 0.51mm/0.020in AHRF300 to AHRF1100 : Tin-plated Copper 0.52mm <sup>2</sup> (20 AWG), ø 0.81mm/0.032in AHRF1300 to AHRF1500 : Tin-plated Copper 0.82mm <sup>2</sup> (18 AWG), ø 1.0mm/0.04in
<b>Soldering Characteristics</b>	Solderability per ANSI/J-STD 002 Category 3
<b>Solder Heat Withstand</b>	Per IEC 68-2-20, Test Tb, Method 1a, Condition b; Can Withstand 10 s at 260°C ± 5°C
<b>Insulating Material</b>	Cured, Flame-retardant Epoxy Polymer; Meets UL 94V-0 Requirements
<b>Operation Temperature</b>	-40°C~125°C

**Note:** See AEC-Q200 for other physical characteristics. Devices are not designed to be placed through a reflow process.

### Environmental Specifications

Test	Conditions	Resistance Change
<b>Passive Aging</b>	70°C, 1000 hrs	±5%
	85°C, 1000 hrs	±5%
<b>Humidity Aging</b>	85°C, 85% R.H., 1000 hrs	±5%
<b>Thermal Shock</b>	125°C, -40°C 10 times	±5%
<b>Solvent Resistance</b>	MIL-STD-202, Method 215F	No change
<b>Note: See AEC-Q200 for other environmental specifications.</b>		
<b>Moisture Resistance Level</b>	Level 1, J-STD-020	
<b>Storage Conditions</b>	40°C max, 70% RH max; devices should remain in original sealed bags prior to use. Devices may not meet specified values if these storage conditions are exceeded.	

### Part Ordering Number System

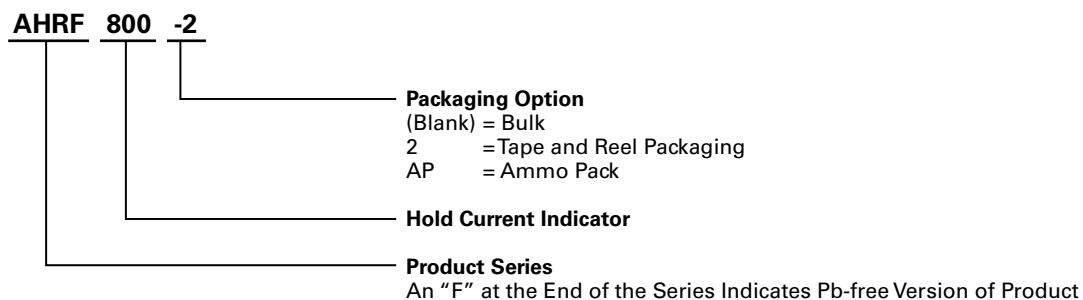

# AHRF

## Radial Leaded

### Dimension Figures

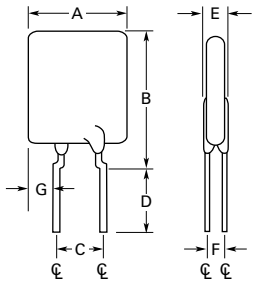

Figure 1

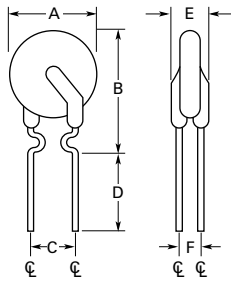

Figure 2

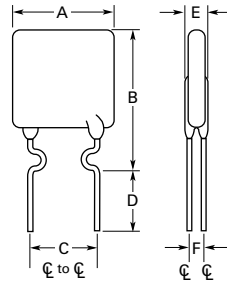

Figure 3

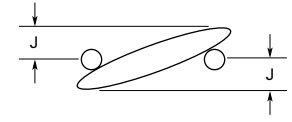

Figure 4

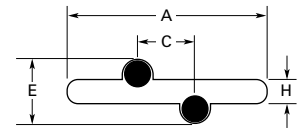

Figure 5

### Dimensions

Part Number	Dimensions in Millimeters (Inches)																Figure
	A		B		C		D		E		F		G		H	J	
	Min	Max	Min	Max	Min	Max	Min	Max	Min	Max	Min	Max	Min	Max	Typ	Typ	
<b>AHRF (High Temperature) – 30V</b>																	
AHRF050	—	7.4 (0.29)	—	12.7 (0.50)	4.3 (0.17)	5.8 (0.23)	7.6 (0.30)	—	—	3.3 (0.13)	1.2 (0.05)	—	—	—	1.24 (0.049)	1.6 (0.06)	2,4,5
AHRF070	—	6.9 (0.27)	—	10.8 (0.43)	4.3 (0.17)	5.8 (0.23)	7.6 (0.30)	—	—	3.3 (0.13)	1.2 (0.05)	—	—	—	1.24 (0.049)	1.6 (0.06)	3,4,5
AHRF100	—	9.7 (0.38)	—	13.6 (0.54)	4.3 (0.17)	5.8 (0.23)	7.6 (0.30)	—	—	3.0 (0.12)	1.2 (0.05)	—	—	—	1.24 (0.049)	1.6 (0.06)	2,4,5
<b>AHRF (High Temperature) – 16V</b>																	
AHRF200	—	9.4 (0.37)	—	14.4 (0.57)	4.3 (0.17)	5.8 (0.23)	7.6 (0.30)	—	—	3.0 (0.12)	1.2 (0.05)	—	—	—	1.24 (0.049)	1.6 (0.06)	2,4,5
AHRF300	—	8.8 (0.35)	—	13.8 (0.55)	4.3 (0.17)	5.8 (0.23)	7.6 (0.30)	—	—	3.0 (0.12)	1.2 (0.05)	—	—	—	1.24 (0.049)	1.6 (0.06)	1,4,5
AHRF400	—	10.0 (0.39)	—	15.0 (0.59)	4.3 (0.17)	5.8 (0.23)	7.6 (0.30)	—	—	3.0 (0.12)	1.2 (0.05)	—	—	—	1.24 (0.049)	1.6 (0.06)	1,4,5
AHRF450	—	10.4 (0.41)	—	15.6 (0.61)	4.3 (0.17)	5.8 (0.23)	7.6 (0.30)	—	—	3.0 (0.12)	1.2 (0.05)	—	—	3.94 (0.155)	1.24 (0.049)	1.6 (0.06)	1,4,5
AHRF550	—	11.2 (0.44)	—	18.9 (0.74)	4.3 (0.17)	5.8 (0.23)	7.6 (0.30)	—	—	3.0 (0.12)	1.2 (0.05)	—	—	—	1.24 (0.049)	1.6 (0.06)	1,4,5
AHRF600	—	11.2 (0.44)	—	21.0 (0.73)	4.3 (0.17)	5.8 (0.23)	7.6 (0.30)	—	—	3.0 (0.12)	1.2 (0.05)	—	—	4.49 (0.177)	1.24 (0.049)	1.7 (0.07)	1,4,5

# AHRF

## Radial Leaded

### Dimension Figures

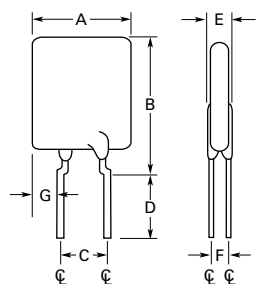

Figure 1

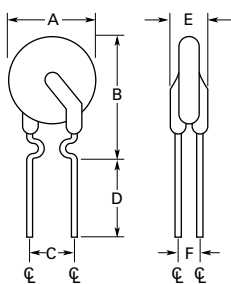

Figure 2

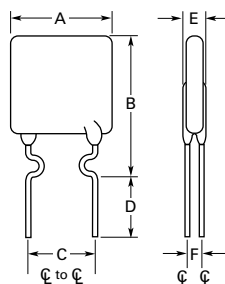

Figure 3

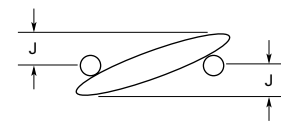

Figure 4

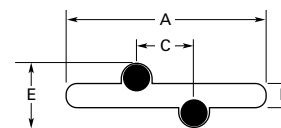

Figure 5

### Dimensions (Cont'd)

Part Number	Dimensions in Millimeters (Inches)															Figure	
	A		B		C		D		E		F		G		H		J
	Min	Max	Min	Max	Min	Max	Min	Max	Min	Max	Min	Max	Min	Max	Typ		Typ
<b>AHRF (High Temperature) – 16V</b>																	
AHRF650	—	12.7 (0.50)	—	22.2 (0.88)	4.3 (0.17)	5.8 (0.23)	7.6 (0.30)	—	—	3.0 (0.12)	1.2 (0.05)	—	—	5.08 (0.200)	1.24 (0.049)	1.8 (0.07)	1,4,5
AHRF700	—	14.0 (0.55)	—	21.9 (0.86)	4.3 (0.17)	5.8 (0.23)	7.6 (0.30)	—	—	3.0 (0.12)	1.2 (0.05)	—	—	—	1.24 (0.049)	1.6 (0.06)	1,4,5
AHRF750	—	14.0 (0.55)	—	23.5 (0.93)	4.3 (0.17)	5.8 (0.23)	7.6 (0.30)	—	—	3.0 (0.12)	1.2 (0.05)	—	—	5.69 (0.224)	1.24 (0.049)	2.0 (0.08)	1,4,5
AHRF800	—	16.5 (0.65)	—	22.5 (0.88)	4.3 (0.17)	5.8 (0.23)	7.6 (0.30)	—	—	3.0 (0.12)	1.2 (0.05)	—	—	—	1.24 (0.049)	1.6 (0.06)	1,4,5
AHRF900	—	16.5 (0.65)	—	25.7 (1.01)	4.3 (0.17)	5.8 (0.23)	7.6 (0.30)	—	—	3.0 (0.12)	1.2 (0.05)	—	—	—	—	—	1,4,5
AHRF1000	—	17.5 (0.69)	—	26.5 (1.04)	9.4 (0.37)	10.9 (0.43)	7.6 (0.30)	—	—	3.0 (0.12)	1.2 (0.05)	—	—	7.47 (0.294)	1.24 (0.049)	1.5 (0.06)	1,4,5
AHRF1100	—	21.0 (0.83)	—	26.1 (1.03)	9.4 (0.37)	10.9 (0.43)	7.6 (0.30)	—	—	3.0 (0.12)	1.2 (0.05)	—	—	—	1.24 (0.049)	1.6 (0.06)	1,4,5
AHRF1300	—	23.5 (0.925)	—	28.7 (1.13)	9.4 (0.37)	10.9 (0.43)	7.6 (0.30)	—	—	3.5 (0.14)	1.4 (0.06)	—	—	7.82 (0.308)	1.45 (0.057)	1.9 (0.08)	1,4,5
AHRF1400	—	23.5 (0.93)	—	28.7 (1.13)	9.4 (0.37)	10.9 (0.43)	7.6 (0.30)	—	—	3.6 (0.14)	1.4 (0.06)	—	—	—	1.24 (0.049)	1.6 (0.06)	1,4,5
AHRF1500	—	23.5 (0.93)	—	28.7 (1.13)	9.4 (0.37)	10.9 (0.43)	7.6 (0.30)	—	—	3.5 (0.14)	1.4 (0.06)	—	—	7.82 (0.308)	—	—	1,4,5

# AHRF

## Radial Leaded

### Packaging and Marking Information

Part Number	Bag Quantity	Tape and Reel Quantity	Ammo Pack Quantity	Standard Package Quantity	Part Marking	Agency Recognition
<b>AHRF (High Temperature)</b>						
AHRF050	500	—	—	10,000	H0.5	*
AHRF050-2	—	2,500	—	12,500	H0.5	*
AHRF050-AP	—	—	2,500	12,500	H0.5	*
AHRF070	500	—	—	10,000	H0.7	*
AHRF070-2	—	2,500	—	12,500	H0.7	*
AHRF070-AP	—	—	2,500	12,500	H0.7	*
AHRF100	500	—	—	10,000	H1	*
AHRF100-2	—	2,500	—	12,500	H1	*
AHRF100-AP	—	—	2,500	12,500	H1	*
AHRF200	500	—	—	10,000	H2	*
AHRF200-2	—	2,500	—	12,500	H2	*
AHRF200-AP	—	—	2,500	12,500	H2	*
AHRF300	500	—	—	10,000	H3	*
AHRF300-2	—	2,000	—	10,000	H3	*
AHRF300-AP	—	—	2,000	10,000	H3	*
AHRF400	500	—	—	10,000	H4	*
AHRF400-2	—	1,500	—	7,500	H4	*
AHRF400-AP	—	—	1,500	7,500	H4	*
AHRF450	500	—	—	10,000	H4.5	*
AHRF450-2	—	1,500	—	7,500	H4.5	*
AHRF450-AP	—	—	1,500	7,500	H4.5	*
AHRF550	500	—	—	10,000	H5.5	*
AHRF550-2	—	2,000	—	10,000	H5.5	*
AHRF550-AP	—	—	2,000	10,000	H5.5	*
AHRF600	500	—	—	10,000	H6	*
AHRF600-2	—	2,000	—	10,000	H6	*
AHRF600-AP	—	—	2,000	10,000	H6	*
AHRF650	500	—	—	10,000	H6.5	*
AHRF650-2	—	1,500	—	7,500	H6.5	*
AHRF650-AP	—	—	1,500	7,500	H6.5	*

\*These devices are intended for use in automotive applications.

# AHRF

## Radial Leaded

### Packaging and Marking Information (Cont'd)

Part Number	Bag Quantity	Tape and Reel Quantity	Ammo Pack Quantity	Standard Package Quantity	Part Marking	Agency Recognition
<b>AHRF (High Temperature)</b>						
AHRF700	500	—	—	10,000	H7	*
AHRF700-2	—	1,500	—	7,500	H7	*
AHRF700-AP	—	—	1,500	7,500	H7	*
AHRF750	500	—	—	10,000	H7.5	*
AHRF750-2	—	1,000	—	5,000	H7.5	*
AHRF750-AP	—	—	1,000	5,000	H7.5	*
AHRF800	500	—	—	10,000	H8	*
AHRF800-2	—	1,000	—	5,000	H8	*
AHRF800-AP	—	—	1,000	5,000	H8	*
AHRF900	250	—	—	5,000	H9	*
AHRF900-2	—	1,000	—	5,000	H9	*
AHRF900-AP	—	—	1,000	5,000	H9	*
AHRF1000	250	—	—	5,000	H10	*
AHRF1000-2	—	1,000	—	5,000	H10	*
AHRF1000-AP	—	—	1,000	5,000	H10	*
AHRF1100	250	—	—	5,000	H11	*
AHRF1100-2	—	1,000	—	5,000	H11	*
AHRF1100-AP	—	—	1,000	5,000	H11	*
AHRF1300	250	—	—	5,000	H13	*
AHRF1300-2	—	1,000	—	5,000	H13	*
AHRF1300-AP	—	—	1,000	5,000	H13	*
AHRF1400	250	—	—	5,000	H14	*
AHRF1400-2	—	1,000	—	5,000	H14	*
AHRF1400-AP	—	—	1,000	5,000	H14	*
AHRF1500	250	—	—	5,000	H15	*
AHRF1500-2	—	1,000	—	5,000	H15	*
AHRF1500-AP	—	—	1,000	5,000	H15	*

\*These devices are intended for use in automotive applications.



# AHRF

## Radial Leaded

### Tape and Reel Specifications

AHRF devices are available in tape and reel packaging per EIA468-B/IEC286-2 and EIA 481-2 standards. See Figures 1 and 2 for details.

Description	EIA Mark	Dimension (mm)	Tolerance
Carrier Tape Width	W	18.0	-0.5/+1.0
Hold Down Tape Width	W <sub>4</sub>	11.0	Minimum
Top Distance between Tape Edges	W <sub>6</sub>	3.0	Maximum
Sprocket Hole Position	W <sub>5</sub>	9.0	-0.5/+0.75
Sprocket Hole Diameter	D <sub>0</sub>	4.0	±0.2
Abscissa to Plane (Kinked Lead) (AHRF050 to AHRF1500)	H <sub>0</sub>	16.0	±0.5
Abscissa to Top (AHRF050 to AHRF450)	H <sub>1</sub>	32.2	Maximum
Abscissa to Top (AHRF550 to AHRF1500*)	H <sub>1</sub>	45.0	Maximum
Overall Width with Lead Protrusion (AHRF050 to AHRF450)	C <sub>1</sub>	43.2	Maximum
Overall Width with Lead Protrusion (AHRF550 to AHRF1500)	C <sub>1</sub>	55.0	Maximum
Overall Width without Lead Protrusion (AHRF050 to AHRF450)	C <sub>2</sub>	42.5	Maximum
Overall Width without Lead Protrusion (AHRF550 to AHRF1500)	C <sub>2</sub>	54.0	Maximum
Lead Protrusion	L <sub>1</sub>	1.0	Maximum
Protrusion of Cut-out	L	11.0	Maximum
Protrusion Beyond Hold-Down Tape	I <sub>2</sub>	Not specified	—
Sprocket Hole Pitch	P <sub>0</sub>	12.7	± 0.3
Device Pitch (AHRF050 to AHRF600)	—	12.7	± 0.3
Device Pitch (AHRF650 to AHRF1500)	—	25.4	± 0.6
Pitch Tolerance	—	20 consec.	± 0.1
Tape Thickness	t	0.9	Maximum
Overall Tape and Lead Thickness (AHRF050 to AHRF1100*)	t <sub>1</sub>	2.0	Maximum
Overall Tape and Lead Thickness (AHRF1300 to AHRF1500*)	t <sub>1</sub>	2.3	Maximum
Splice Sprocket Hole Alignment	—	0	± 0.3
Body Lateral Deviation	h	0	± 1.0
Body Tape Plane Deviation	p	0	± 1.3
Ordinate to Adjacent Component Lead (AHRF050 to AHRF900)	P <sub>1</sub>	3.81	± 0.7
Ordinate to Adjacent Component Lead (AHRF1000 to AHRF1500)	P <sub>1</sub>	7.62	± 0.7
Lead Spacing (AHRF050 to AHRF900*)	F	5.05	± 0.75
Lead Spacing (AHRF1000 to AHRF1500*)	F	10.15	± 0.75
Reel Width (AHRF050 to AHRF450)	w <sub>2</sub>	56.0	Maximum
Reel Width (AHRF550 to AHRF1500*)	w <sub>2</sub>	63.5	Maximum
Reel Diameter	A	370.0	Maximum
Arbor Hold Diameter	c	26.0	±12.0
Core Diameter*	n	91.0	Maximum
Box	—	64/372/362	Maximum
Consecutive Missing Places	—	None	—
Empty Places per Reel	—	0.1%	Maximum

\*Differs from EIA specification.

# AHRF

## Radial Leaded

### Tape and Reel Diagrams

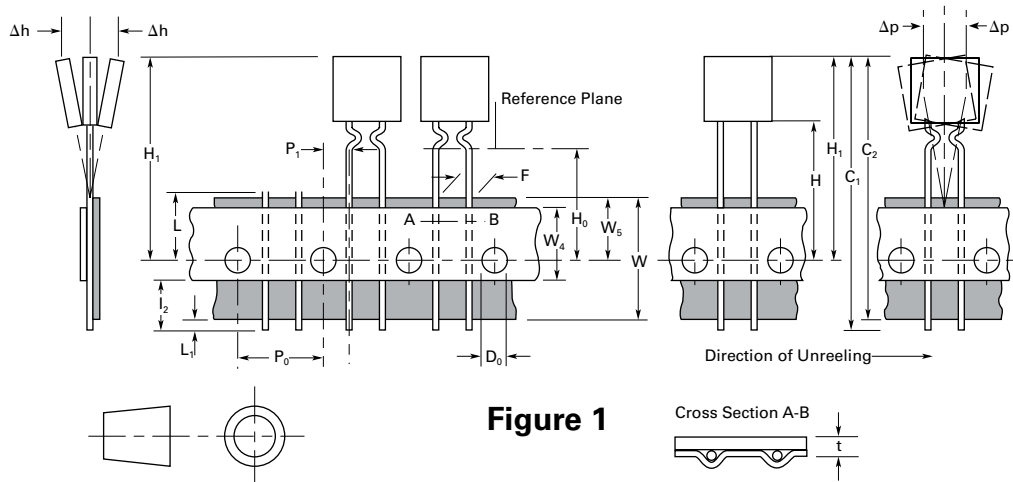

**Figure 1**

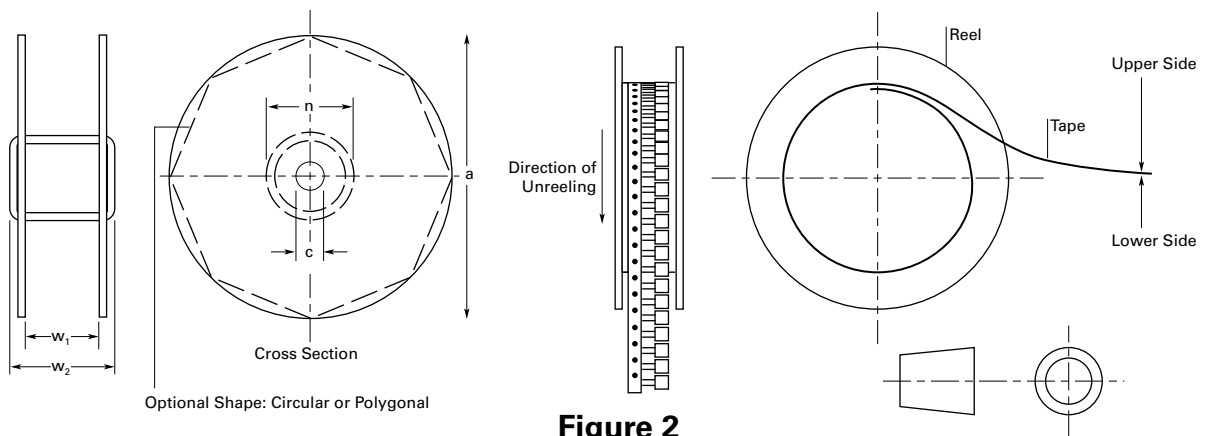

**Figure 2**

### Warning

- Users should independently evaluate the suitability of and test each product selected for their own application.
- Operation beyond the maximum ratings or improper use may result in device damage and possible electrical arcing and flame.
- These devices are intended for protection against damage caused by occasional overcurrent or overtemperature fault conditions and should not be used when repeated fault conditions or prolonged trip events are anticipated.
- Contamination of the PPTC material with certain silicone-based oils or some aggressive solvents can adversely impact the performance of the devices.
- Device performance can be impacted negatively if devices are handled in a manner inconsistent with recommended electronic, thermal, and mechanical procedures for electronic components.
- PPTC devices are not recommended for installation in applications where the device is constrained such that its PTC properties are inhibited, for example in rigid potting materials or in rigid housings, which lack adequate clearance to accommodate device expansion.
- Operation in circuits with a large inductance can generate a circuit voltage ( $Ldi/dt$ ) above the rated voltage of the device.

**Disclaimer Notice** - Information furnished is believed to be accurate and reliable. However, users should independently evaluate the suitability of and test each product selected for their own applications. Littelfuse products are not designed for, and may not be used in, all applications. Read complete Disclaimer Notice at [www.littelfuse.com/disclaimer-electronics](http://www.littelfuse.com/disclaimer-electronics).