

# ORB SERIES

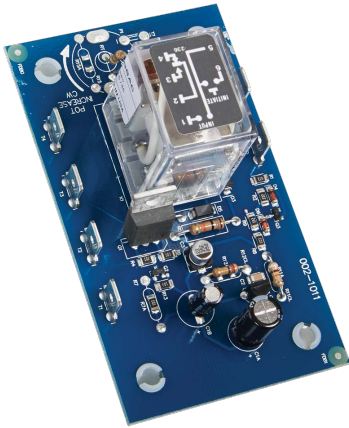

## Description

The ORB Series' open PCB construction offers the user good economy without sacrificing performance and reliability. The output relay is available in isolated, 10A, DPDT or SPDT forms. The time delay may be ordered as factory fixed, onboard knob, or external adjustment. All connections are 0.25 in. (6.35 mm) male quick connect terminals.

### Operation (Delay-on-Break)

Input voltage must be applied before and during timing. Upon closure of the initiate switch, the output relay energizes. The time delay begins when the initiate switch is opened (trailing edge triggered). The output remains energized during timing. At the end of the time delay, the output de-energizes. The output will energize if the initiate switch is closed when input voltage is applied.

**Reset:** Reclosing the initiate switch during timing resets the time delay. Loss of input voltage resets the time delay and output.

## Wiring Diagram

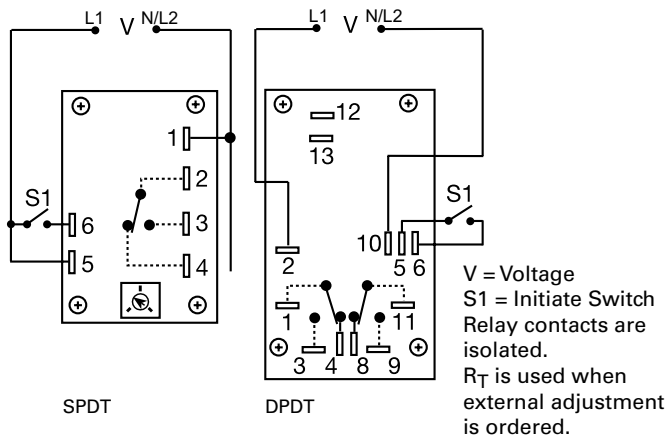



## Features & Benefits

FEATURES	BENEFITS
<b>Open PCB construction</b>	Reduces cost for OEM applications
<b>Analog circuitry</b>	Repeat accuracy + / - 2%, Factory calibration + / - 10%
<b>Isolated, 10A, SPDT or DPDT output contacts</b>	Allows control of loads for AC or DC voltages
<b>Line voltage initiation</b>	Separate control voltage is not required for operation

## Accessories

 **P1004-12, P1004-12-X Versa-Pot**  
Panel mountable, industrial potentiometer recommended for remote time delay adjustment.

 **P0700-7 Versa-Knob**  
Designed for 0.25 in (6.35 mm) shaft of Versa-Pot. Semi-gloss industrial black finish.

 **P1015-64 (AWG 14/16) Female Quick Connect**  
These 0.25 in. (6.35 mm) female terminals are constructed with an insulator barrel to provide strain relief.

 **P1015-18 Quick Connect to Screw Adapter**  
Screw adapter terminal designed for use with all modules with 0.25 in. (6.35 mm) male quick connect terminals.

## Ordering Information

MODEL	INPUT VOLTAGE	ADJUSTMENT	TIME DELAY	OUTPUT FORM
ORB120A160	120VAC	Fixed	60s	SPDT
ORB120A25	120VAC	Onboard	3 - 300s	SPDT
ORB24A11D	24VAC	Fixed	1s	DPDT
ORB24A21D	24VAC	Onboard	0.05 - 3s	DPDT
ORB24A25	24VAC	Onboard	3 - 300s	SPDT

If you don't find the part you need, call us for a custom product 800-843-8848

# ORB SERIES

## Specifications

### Time Delay

**Type** Analog circuitry  
**Range** 0.05 - 300s in 5 adjustable ranges or fixed  
**Repeat Accuracy** ±2% or 20ms, whichever is greater  
**Tolerance (Factory Calibration)** Adjustable: guaranteed range  
 Fixed: ±10%

**Reset Time** ≤ 50ms  
**Initiate Time** ≤ 70ms  
**Time Delay vs Temp. & Voltage** ≤ ±10%

### Input

**Voltage** 24, 120, or 230VAC  
**Tolerance**  
**24VAC** -15% - 20%  
**120 & 230VAC** -20% - 10%  
**AC Line Frequency** 50/60 Hz  
**Power Consumption** 2.25W

### Output

**Type** Electromechanical relay  
**Form** Isolated, SPDT or DPDT  
**Rating** 10A resistive @ 120/240VAC & 28VDC;  
 1/3 hp @ 120/240VAC  
**Life** Mechanical - 1x10<sup>7</sup>; Electrical - 1x10<sup>6</sup>

### Protection

**Isolation Voltage** ≥1500V RMS input to output

### Mechanical

**Mounting** Surface mount with four #6 (M3.5 x 0.6) screws  
**Dimensions** **H** 53.8 mm (2.12"); **W** 93.7 mm (3.69");  
**D** 47.8 mm (1.88")

**Termination** 0.25 in. (6.35 mm) male quick connect terminals

### Environmental

**Operating/Storage Temperature** -20° to 65°C / -30° to 85°C  
**Weight** ≈ 2.7 oz (77 g)

## Selection Guides

R <sub>T</sub> Selection Chart					
Desired Time Delay*					R <sub>T</sub> Megohm
Seconds					
1	2	3	4	5	
0.05	0.5	0.6	1.2	3.0	0.0
0.5	5.0	10	20	50	0.5
1.0	10	20	40	100	1.0
1.5	15	30	60	150	1.5
2.0	20	40	80	200	2.0
2.5	25	50	100	250	2.5
3.0	30	60	120	300	3.0

\* When selecting an external R<sub>T</sub> add at least 20% for tolerance of unit and the R<sub>T</sub>.

## Function Diagram

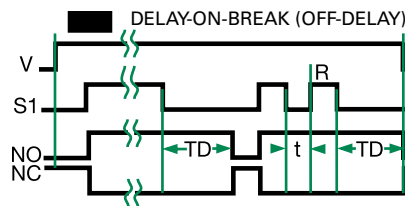

V = Voltage  
 S1 = Initiate Switch  
 NO = Normally Open Contact  
 NC = Normally Closed Contact  
 TD = Time Delay  
 t = Incomplete Time Delay  
 R = Reset  
 = Undefined Time