

### MBRF20200CTR

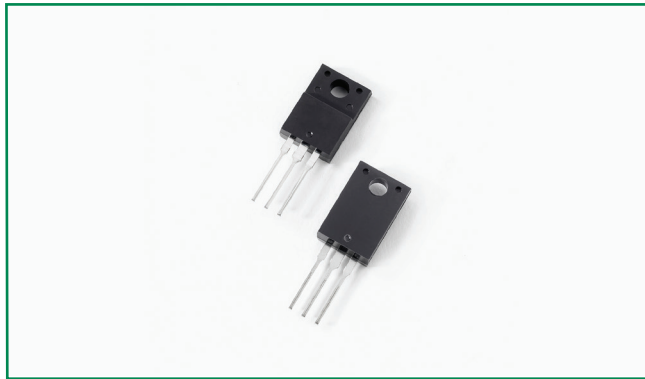

#### Pin out

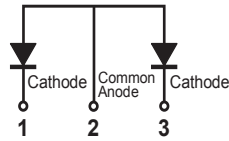

#### Description

Littelfuse MBR series Schottky Barrier Rectifier is designed to meet the general requirements of commercial applications by providing high temperature, low leakage and low  $V_F$  products.

It is suitable for high frequency switching mode power supply, free-wheeling diodes and polarity protection diodes.

#### Features

- High junction temperature capability
- High frequency operation
- Guard ring for enhanced ruggedness and long term reliability
- Common anode configuration in electrically isolated ITO-220AB package
- Low forward voltage drop

#### Applications

- Switching mode power supply
- DC/DC converters
- Free-wheeling diodes
- Polarity protection diodes

#### Maximum Ratings

Parameters	Symbol	Test Conditions	Max	Unit
Peak Inverse Voltage	$V_{RWM}$	-	200	V
Average Forward Current	$I_{F(AV)}$	50% duty cycle @ $T_C = 105^\circ\text{C}$ , rectangular wave form	10(per leg) 20(per device)	A
Peak Repetitive Forward Current(per leg)	$I_{FRM}$	Rated $V_R$ , Square wave, 20KHz, @ $T_C = 90^\circ\text{C}$	20	A
Peak One Cycle Non-Repetitive Surge Current (per leg)	$I_{FSM}$	8.3 ms, half Sine pulse	150	A

#### Electrical Characteristics

Parameters	Symbol	Test Conditions	Max	Unit
Forward Voltage Drop (per leg) *	$V_{F1}$	@ 10A, Pulse, $T_J = 25^\circ\text{C}$	0.95	V
	$V_{F2}$	@ 10A, Pulse, $T_J = 125^\circ\text{C}$	0.85	
Reverse Current at DC condition (per leg)	$I_{R1}$	@ $V_R = \text{rated } V_R$ , $T_J = 25^\circ\text{C}$	1.0	mA
Reverse Current (per leg) *	$I_{R2}$	@ $V_R = \text{rated } V_R$ , $T_J = 125^\circ\text{C}$	50	
Junction Capacitance (per leg)	$C_T$	@ $V_R = 5\text{V}$ , $T_C = 25^\circ\text{C}$ , $f_{SIG} = 1\text{MHz}$	300	pF
Series Inductance (per leg)	$L_S$	Measured lead to lead 5 mm from package body	8.0	nH
Voltage Rate of Change	dv/dt		10,000	V/ $\mu\text{s}$
RSM Isolation Voltage (t = 1.0 second, R. H. < =30%, $T_A = 25^\circ\text{C}$ )	$V_{ISO}$	Clip mounting, the epoxy body away from the heatsink edge by more than 0.110" along the lead direction.	4500	V
		Clip mounting, the epoxy body is inside the heatsink.	3500	
		Screw mounting, the epoxy body is inside the heatsink.	1500	

\* Pulse Width < 300 $\mu\text{s}$ , Duty Cycle < 2%

### Thermal-Mechanical Specifications

Parameters	Symbol	Test Conditions	Max	Unit
Junction Temperature	$T_J$		-55 to +175	°C
Storage Temperature	$T_{stg}$		-55 to +175	°C
Maximum Thermal Resistance Junction to Case (per leg)	$R_{thJC}$	DC operation	4.5	°C/W
Approximate Weight	wt		2	g
Case Style		ITO-220AB		

Figure 1: Typical Forward Characteristics

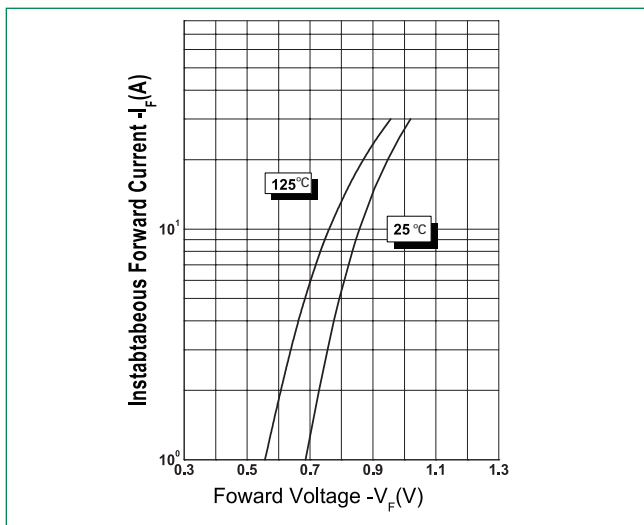

Figure 2: Typical Reverse Characteristics

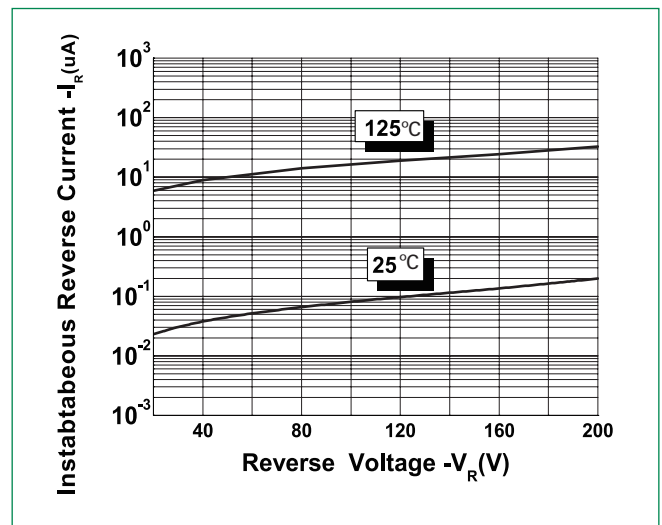
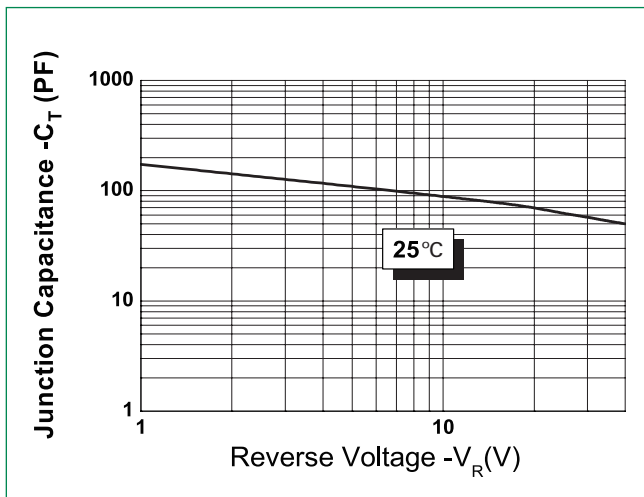

Figure 3: Typical Junction Capacitance



**Dimensions- ITO-220AB**



Symbol	Millimeters		
	Min	Typ	Max
<b>A</b>	4.30	4.50	4.70
<b>A1</b>	1.10	1.30	1.50
<b>A2</b>	2.80	3.00	3.20
<b>A3</b>	2.50	2.70	2.90
<b>b</b>	0.50	0.60	0.75
<b>b1</b>	1.10	1.20	1.35
<b>b2</b>	1.50	1.60	1.75
<b>b3</b>	1.20	1.30	1.45
<b>b4</b>	1.60	1.70	1.85
<b>c</b>	0.55	0.60	0.75
<b>D</b>	14.80	15.00	15.20
<b>E</b>	9.96	10.16	10.36
<b>e</b>		2.55	
<b>e1</b>		5.10	
<b>H1</b>	6.50	6.70	6.90
<b>L</b>	12.70	13.20	13.70
<b>L1</b>	1.60	1.80	2.00
<b>L2</b>	0.80	1.00	1.20
<b>L3</b>	0.60	0.80	1.00
<b>ØP1</b>	3.30	3.50	3.70
<b>ØP2</b>	2.99	3.19	3.39
<b>Q</b>	2.50	2.70	2.90
<b>θ1</b>		5°	
<b>θ2</b>		4°	
<b>θ3</b>		10°	
<b>θ4</b>		5°	
<b>θ5</b>		5°	

**Packing Options**

Part Number	Marking	Packing Mode	M.O.O
MBRF20200CTR	MBRF20200CTR	50pcs / Tube	1000

**Tube Specification**

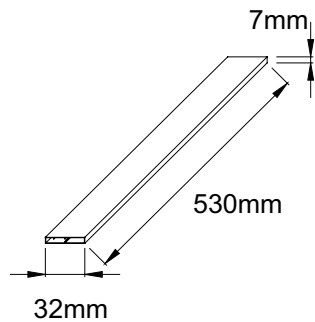

**Part Numbering and Marking System**

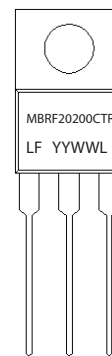

- MBR = Device Type
- F = Package type
- 20 = Forward Current (20A)
- 200 = Reverse Voltage (200V)
- CTR = Configuration
- LF = Littelfuse
- YY = Year
- WW = Week
- L = Lot Number