



INSTALLATION INSTRUCTIONS FOR SYMCOM'S MOTORSAVER®

MODEL 460-15

(Two Isolated Normally Open Contacts)

DANGER!



HAZARDOUS VOLTAGES MAY BE PRESENT DURING INSTALLATION.
Electrical shock can cause death or serious injury.



Installation should be done by qualified personnel following all national, state and local electrical codes.

**BE SURE POWER IS DISCONNECTED PRIOR TO INSTALLATION!
FOLLOW NATIONAL, STATE, AND LOCAL CODES!
READ THESE INSTRUCTIONS ENTIRELY BEFORE INSTALLATION!**

! WARNING !

UNEXPECTED OUTPUT ACTUATION CAN OCCUR.

Use hard-wired safety interlocks where personnel and/or equipment hazards exist.
Failure to follow this instruction can result in death, injury or equipment damage.

The Model 460-15 MotorSaver® is an auto ranging voltage monitor designed to protect three-phase motors regardless of size. The MotorSaver® is used on 190-480 VAC, 50 to 60 Hz motors to protect from damage caused by single phasing, low voltage, high voltage, phase reversal, and voltage unbalance. The isolated output contacts allow separate power sources to be used for control circuits.

CONNECTIONS

1. Mount the MotorSaver® in a convenient location in or near the motor control panel. If the location is wet or dusty, the MotorSaver® should be mounted in a NEMA 4 or 12 enclosure. The MotorSaver® can be mounted to a back panel using two #6 or #8 x 5/8 screws or can be snapped onto a DIN rail.
2. Connect L1, L2 and L3 on the MotorSaver's terminal strip to the LINE SIDE of the motor starter. (See Figure No. 1).
3. Connect the output relay to the circuitry to be controlled. For motor control, connect one normally open contact in series with the magnetic coil of the motor starter as shown in Figure No. 1. Use the other normally open contacts for a PLC input or other controls.



www.SymCom.com

...your electronic control & protection specialists

222 Disk Drive, Rapid City, SD 57701
(800) 843-8848 www.symcom.com

II-460-15-B

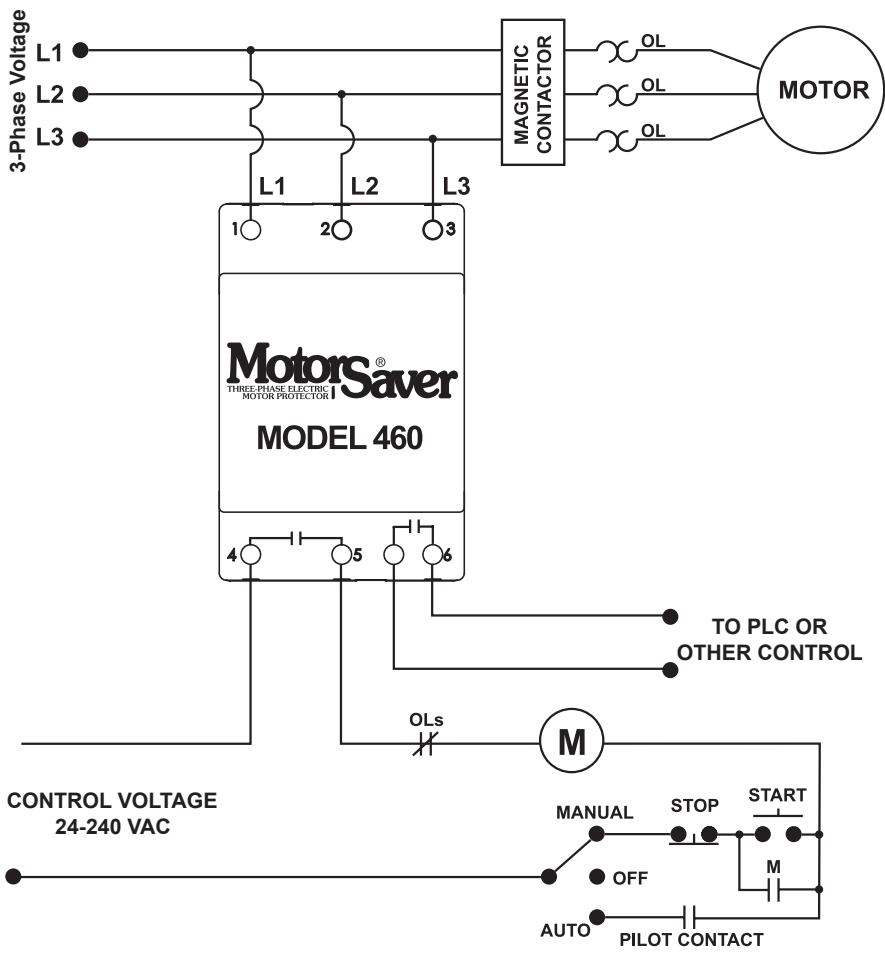
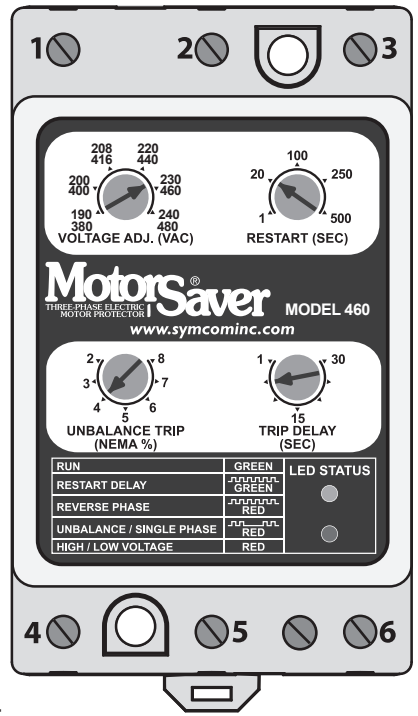

FIGURE NO. 1: CONTROL WIRING DIAGRAM

SETTINGS

1. Line voltage adjustment: Rotate the “**VOLTAGE ADJ. (VAC)**” to the nominal three-phase line voltage feeding the motor to be protected.
2. Restart delay adjustment: Rotate the “**RESTART (SEC)**” adjustment to the desired position. The restart delay is the time between MotorSaver® seeing acceptable voltage and the MotorSaver® energizing its output relay. For compressor applications, the restart delay should be set for the approximate time it takes for the head pressure to bleed off of the compressor. For other applications, the restart delay is typically set between 2 and 10 seconds.
3. Trip delay adjustment: Rotate the “**TRIP DELAY (SEC)**” adjustment to the desired setting. This adjustment does not affect the trip delay on phasing faults. Typically, the trip delay adjustment is set between 1 and 5 seconds. In areas where voltage fluctuations are frequent, the trip delay adjustment may be set greater than 10 seconds.
4. Voltage unbalance adjustment: Rotate the “**UNBALANCE TRIP (NEMA%)**” adjustment to the desired unbalance trip level. The NEMA MG1 standard does not recommend operating a motor above 1% voltage unbalance without derating the motor. The NEMA MG1 standard also recommends against operating a motor above a 5% voltage unbalance under any circumstances. SymCom recommends consulting the motor manufacturer for specific tolerances.



$$\text{Percent Unbalance} = \frac{\text{Maximum Deviation from the Average}}{\text{Average}} \times 100$$

Example: The measured line-to-line voltages are 203, 210, and 212.

$$\text{Average} = \frac{203 + 210 + 212}{3} = 208.3$$

The maximum deviation from the average is the largest difference between the average voltage (208.3) and any one voltage reading.



$$208.3 - 203 = 5.3 \quad 210 - 208.3 = 1.7 \quad 212 - 208.3 = 3.7$$

The maximum deviation from the average is 5.3.

$$\frac{5.3}{208.3} \times 100 = 2.5\% \text{ Unbalance}$$





POWER-UP

Turn on the 3Ø power to the motor. The MotorSaver's green RUN light will blink during the RESTART delay. After the RESTART delay, the MotorSaver® will energize its output contacts and the green RUN light will illuminate. If the contacts do not energize and the RUN light does not illuminate, see the TROUBLESHOOTING section.

<u>DIAGNOSTIC INDICATOR LIGHTS</u>	
RUN	GREEN
RESTART DELAY	 GREEN
REVERSE PHASE	 RED
UNBALANCE / SINGLE PHASE	 RED
HIGH / LOW VOLTAGE	RED

**CONGRATULATIONS!!
YOU HAVE JUST INSTALLED THE FINEST
MOTOR PROTECTION AVAILABLE!!**

TROUBLESHOOTING

SYMPTOM	LIGHT PATTERN	SOLUTION
No lights are on. The unit seems completely dead.	N / A	Measure the three line-to-line voltages. If any of the voltages are below 150 VAC, the MotorSaver® does not have enough power to operate its internal electronics. This may occur on a single-phased system. If the voltages are correct, call SymCom at 1-800-843-8848 or 1-605-348-5580.
Red light is blinking (on initial power up).		Turn off the three-phase power. Swap any two leads powering the MotorSaver® (L1, L2, or L3). There is a 50-50 chance of connecting L1, L2, and L3 correctly the first time. Re-apply the three-phase power.
Red light is blinking (after the motor has been previously running).		The incoming lines have been reverse phased. The MotorSaver® is preventing the motor from running backwards. Correct the phase sequence.
Red light is blinking in this pattern.		The voltage is unbalanced or single-phased. Measure the incoming line voltages and calculate the % unbalance. If the voltage unbalance does not exceed the % unbalance reset value, call SymCom at 1-800-843-8848 or 1-605-348-5580.
Red light is on steady.	RED	The voltage is out of tolerance. Measure the three line-to-line voltages. Calculate the average of the three voltages. If the average is 7% above or below the nominal voltage as selected by the LINE VOLTAGE ADJUST, the MotorSaver® is functioning properly. If the voltage is within $\pm 7\%$ of the selected line voltage, call SymCom at 1-800-843-8848 or 1-605-348-5580.
Green light blinks and motor is not running.		The MotorSaver® is in restart delay.
Green light is on steady, but motor does not start.	GREEN	The MotorSaver® is in run mode. Ensure other control devices are allowing the motor to start. Check control circuit for loose wires or malfunctioning switches.

Any questions or comments call SymCom at 1-800-843-8848 or 1-605-348-5580

SPECIFICATIONS

3 - Phase Line Voltage	190 - 480 VAC
Frequency	50* - 60 Hz
Low Voltage (% of setpoint)	
Trip	90% \pm 1%
Reset	93% \pm 1%
High Voltage (% of setpoint)	
Trip	110% \pm 1%
Reset	107% \pm 1%
Voltage Unbalance (NEMA)	
Trip	2 - 8% Adjustable
Reset	Trip Setting minus 1% (5 - 8%)
	Trip Setting minus 0.5% (2 - 4%)
Trip Delay Time	
Low, High, and Unbalanced Voltage	1 - 30 Seconds Adjustable
Single-phasing faults (>25% UB)	1 Second Fixed
Restart Delay Time	
After a fault or complete power loss	1 - 500 Seconds Adjustable
Output Contact Rating - DPST	
Pilot Duty	480 VA @ 240 VAC
General Purpose	8 A @ 240 VAC
Power Consumption	6 Watts (maximum)
Weight	14 oz
Enclosure	Polycarbonate
Terminal	
Torque	6 Inch-Pounds Max.
Wire AWG	12 - 20 AWG
Safety Marks	
UL	UL508 (File # E68520)
CE	IEC 60947-6-2
Standards Passed	
Electrostatic Discharge (ESD)	IEC 1000-4-2, Level 3, 6 kv contact, 8 kv air
Radio Frequency Immunity, Radiated	159 MHz, 10 V/m
Fast Transient Burst	IEC 1000-4-4, Level 3, 3.5 kv input power and controls

*NOTE: 50 Hz will increase all delay timers by 20%

Surge	
IEC	IEC 1000-4-5, Level 3, 4kv line-to-line; Level 4, 4kv line-to-ground
ANSI / IEEE	C62.41 Surge and Ring Wave Compliance to a level of 6kv line-to-line
Hi-potential Test	Meets UL508 (2 x rated V +1000V for 1 minute)
Environmental	
Temperature Range	Ambient Operating: -20° - 70° C (-4° - 158°F) Ambient Storage: -40° - 80° C (-40° - 176°F)
Class of Protection	IP20, NEMA 1 (Finger Safe)
Relative Humidity	10-95%, non-condensing per IEC 68-2-3

DIMENSIONS

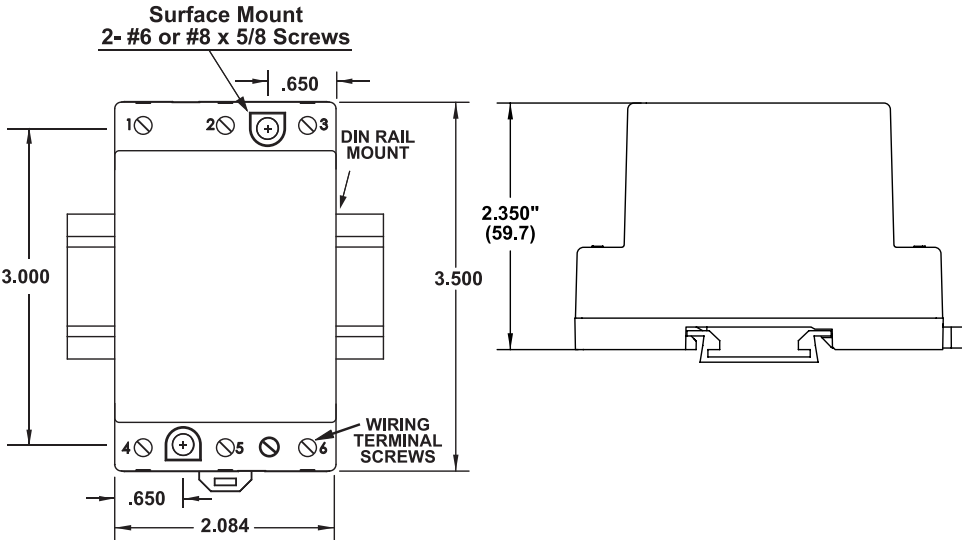

SymCom warrants its microcontroller based products against defects in material or workmanship for a period of five (5) years* from the date of manufacture. All other products manufactured by SymCom shall be warranted against defects in material and workmanship for a period of two (2) years from the date of manufacture. For complete information on warranty, liability, terms, and conditions, please refer to the SymCom Terms and Conditions of Sale document.

**Visit our website at [www. symcom.com](http://www.symcom.com) for our complete
catelogs and new product listings!**



www.SymCom.com

...your electronic control & protection specialists

222 Disk Drive, Rapid City, SD 57701
(800) 843-8848 www.symcom.com