

# X2-Class Power MOSFET

## IXTY14N60X2

$V_{DSS} = 600V$   
 $I_{D25} = 14A$   
 $R_{DS(on)} \leq 250m\Omega$

N-Channel Enhancement Mode

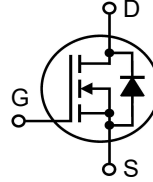

TO-252  
(IXTY)

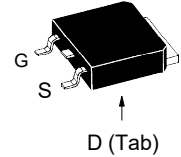

G = Gate      D = Drain  
 S = Source    Tab = Drain

Symbol	Test Conditions	Maximum Ratings	
$V_{DSS}$	$T_J = 25^\circ C$ to $150^\circ C$	600	V
$V_{DGR}$	$T_J = 25^\circ C$ to $150^\circ C$ , $R_{GS} = 1M\Omega$	600	V
$V_{GSS}$	Continuous	$\pm 30$	V
$V_{GSM}$	Transient	$\pm 40$	V
$I_{D25}$	$T_C = 25^\circ C$	14	A
$I_{DM}$	$T_C = 25^\circ C$ , Pulse Width Limited by $T_{JM}$	18	A
$I_A$	$T_C = 25^\circ C$	7	A
$E_{AS}$	$T_C = 25^\circ C$	150	mJ
$dv/dt$	$I_S \leq I_{DM}$ , $V_{DD} \leq V_{DSS}$ , $T_J \leq 150^\circ C$	15	V/ns
$P_D$	$T_C = 25^\circ C$	180	W
$T_J$		-55 ... +150	$^\circ C$
$T_{JM}$		150	$^\circ C$
$T_{stg}$		-55 ... +150	$^\circ C$
$T_{SOLD}$	Plastic Body for 10s	260	$^\circ C$
<b>Weight</b>		0.35	g

### Features

- International Standard Package
- Low  $R_{DS(ON)}$  and  $Q_G$
- Avalanche Rated
- Low Package Inductance

### Advantages

- High Power Density
- Easy to Mount
- Space Savings

### Applications

- Switch-Mode and Resonant-Mode Power Supplies
- DC-DC Converters
- PFC Circuits
- AC and DC Motor Drives
- Robotics and Servo Controls

Symbol	Test Conditions ( $T_J = 25^\circ C$ , Unless Otherwise Specified)	Characteristic Values		
		Min.	Typ.	Max.
$BV_{DSS}$	$V_{GS} = 0V$ , $I_D = 250\mu A$	600		V
$V_{GS(th)}$	$V_{DS} = V_{GS}$ , $I_D = 250\mu A$	2.5		4.5 V
$I_{GSS}$	$V_{GS} = \pm 30V$ , $V_{DS} = 0V$			$\pm 100$ nA
$I_{DSS}$	$V_{DS} = V_{DSS}$ , $V_{GS} = 0V$ $T_J = 125^\circ C$			10 $\mu A$ 150 $\mu A$
$R_{DS(on)}$	$V_{GS} = 10V$ , $I_D = 0.5 \cdot I_{D25}$ , Note 1			250 m $\Omega$

Symbol	Test Conditions ( $T_J = 25^\circ\text{C}$ , Unless Otherwise Specified)	Characteristic Values		
		Min.	Typ.	Max
$g_{fs}$	$V_{DS} = 10\text{V}$ , $I_D = 0.5 \cdot I_{D25}$ , Note 1	7	12	S
$R_{Gi}$	Gate Input Resistance		5	$\Omega$
$C_{iss}$	} $V_{GS} = 0\text{V}$ , $V_{DS} = 25\text{V}$ , $f = 1\text{MHz}$		740	pF
$C_{oss}$			1310	pF
$C_{rss}$			20	pF
<b>Effective Output Capacitance</b>				
$C_{o(er)}$	Energy related } $V_{GS} = 0\text{V}$		55	pF
$C_{o(tr)}$	Time related } $V_{DS} = 0.8 \cdot V_{DSS}$		160	pF
<b>Resistive Switching Times</b>				
$t_{d(on)}$	} $V_{GS} = 10\text{V}$ , $V_{DS} = 0.5 \cdot V_{DSS}$ , $I_D = 0.5 \cdot I_{D25}$ $R_G = 30\Omega$ (External)		23	ns
$t_r$			27	ns
$t_{d(off)}$			75	ns
$t_f$			17	ns
$Q_{g(on)}$	} $V_{GS} = 10\text{V}$ , $V_{DS} = 0.5 \cdot V_{DSS}$ , $I_D = 0.5 \cdot I_{D25}$		16.7	nC
$Q_{gs}$			4.7	nC
$Q_{gd}$			7.7	nC
$R_{thJC}$				0.69 $^\circ\text{C/W}$

**Source-Drain Diode**

Symbol	Test Conditions ( $T_J = 25^\circ\text{C}$ , Unless Otherwise Specified)	Characteristic Values		
		Min.	Typ.	Max
$I_s$	$V_{GS} = 0\text{V}$			14 A
$I_{SM}$	Repetitive, pulse Width Limited by $T_{JM}$			56 A
$V_{SD}$	$I_F = I_s$ , $V_{GS} = 0\text{V}$ , Note 1			1.4 V
$t_{rr}$	} $I_F = 7\text{A}$ , $-di/dt = 100\text{A}/\mu\text{s}$ $V_R = 100\text{V}$		320	ns
$Q_{RM}$			4.3	$\mu\text{C}$
$I_{RM}$			27.0	A

Note 1. Pulse test,  $t \leq 300\mu\text{s}$ , duty cycle,  $d \leq 2\%$ .

Littelfuse reserves the right to change limits, test conditions and dimensions.

IXYS MOSFETs and IGBTs are covered by one or more of the following U.S. patents:	4,835,592	4,931,844	5,049,961	5,237,481	6,162,665	6,404,065B1	6,683,344	6,727,585	7,005,734B2	7,157,338B2
	4,860,072	5,017,508	5,063,307	5,381,025	6,259,123B1	6,534,343	6,710,405B2	6,759,692	7,063,975B2	
	4,881,106	5,034,796	5,187,117	5,486,715	6,306,728B1	6,583,505	6,710,463	6,771,478B2	7,071,537	

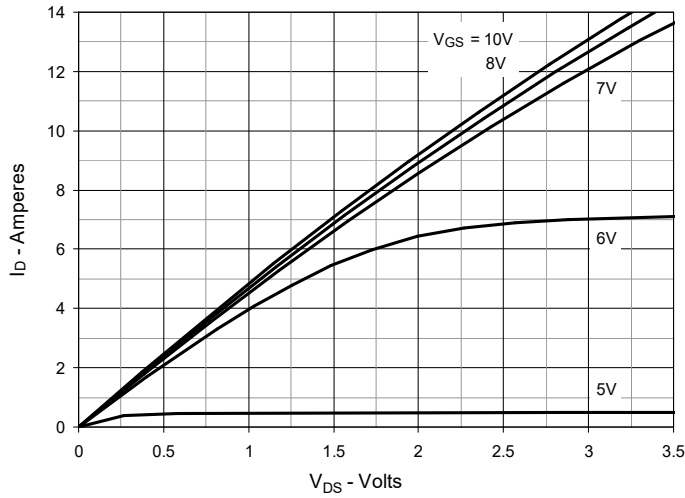
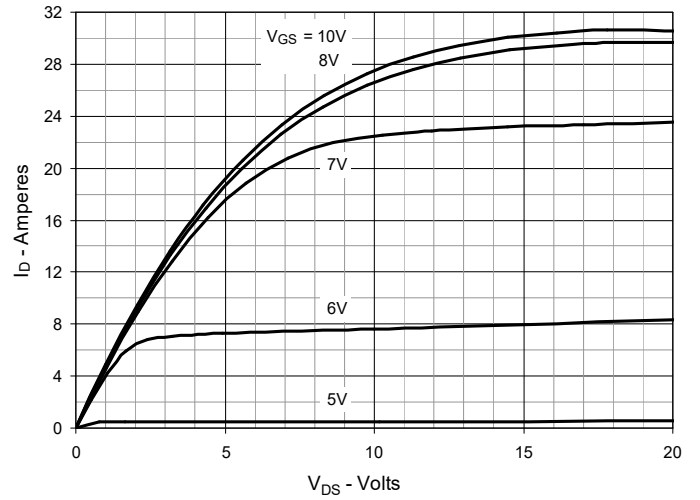
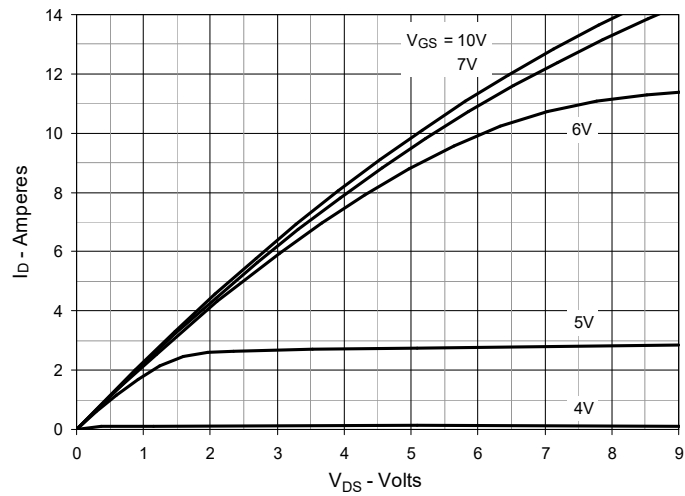
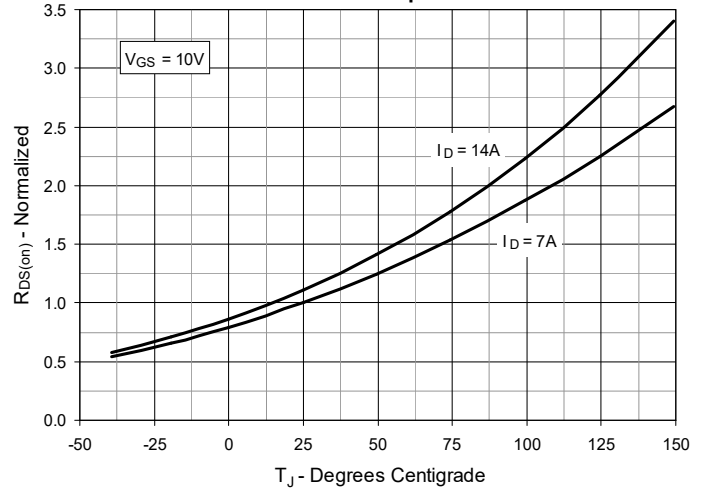
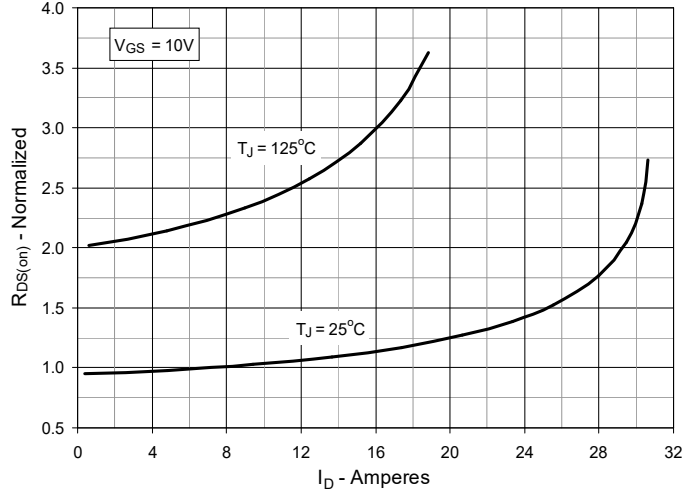
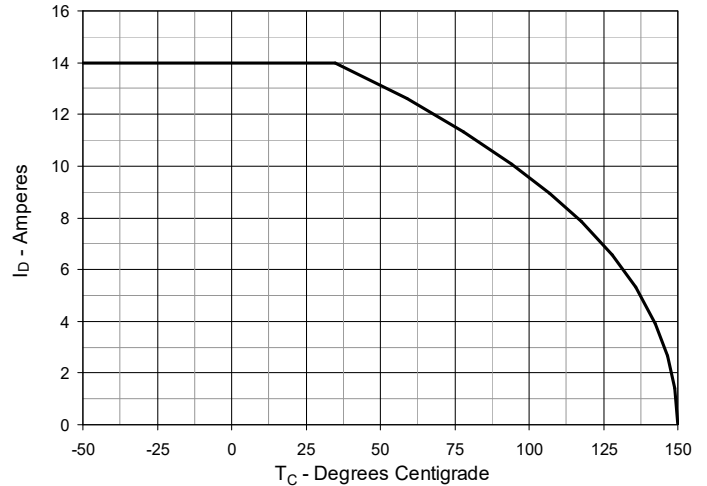
**Fig. 1. Output Characteristics @  $T_J = 25^\circ\text{C}$** 

**Fig. 2. Extended Output Characteristics @  $T_J = 25^\circ\text{C}$** 

**Fig. 3. Output Characteristics @  $T_J = 125^\circ\text{C}$** 

**Fig. 4.  $R_{DS(on)}$  Normalized to  $I_D = 7\text{A}$  Value vs. Junction Temperature**

**Fig. 5.  $R_{DS(on)}$  Normalized to  $I_D = 7\text{A}$  Value vs. Drain Current**

**Fig. 6. Maximum Drain Current vs. Case Temperature**

**Fig. 7. Input Admittance**

**Fig. 8. Transconductance**

**Fig. 9. Forward Voltage Drop of Intrinsic Diode**

**Fig. 10. Gate Charge**

**Fig. 11. Capacitance**

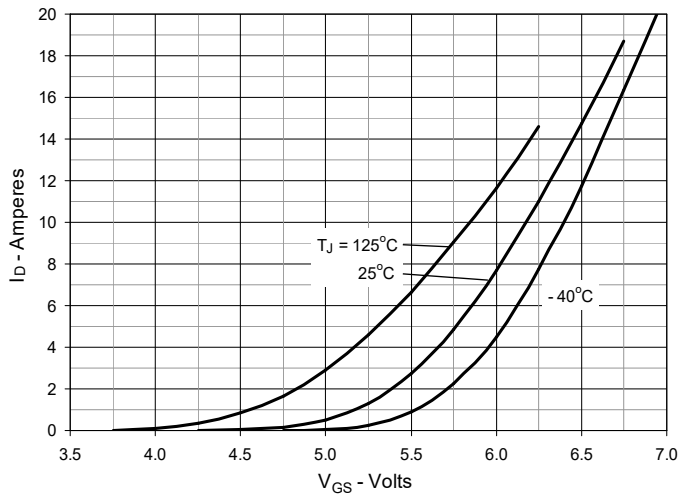
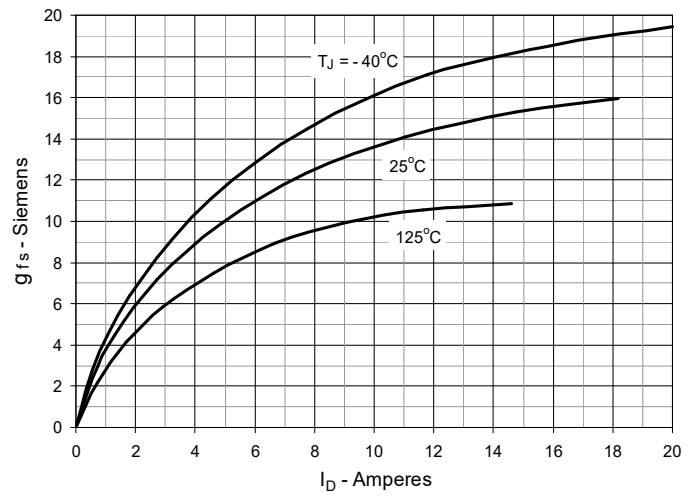
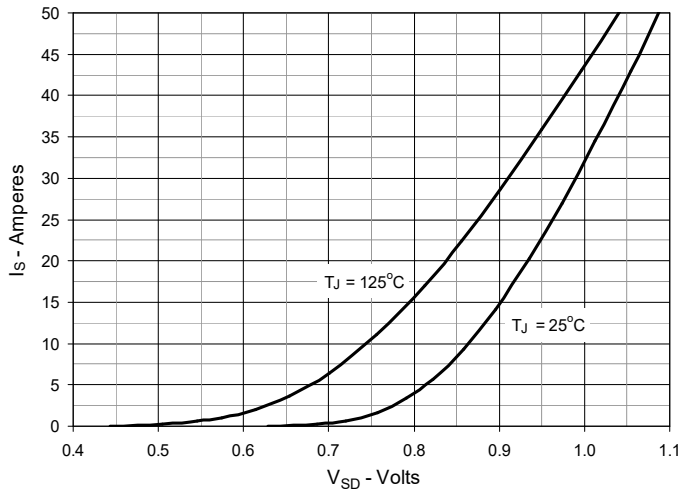
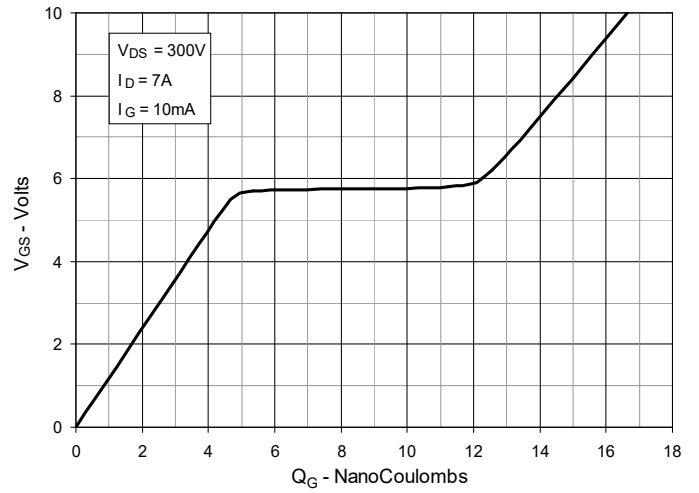
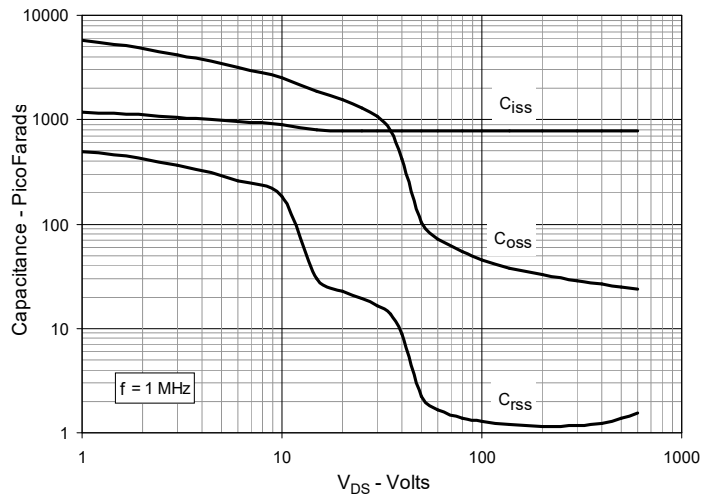
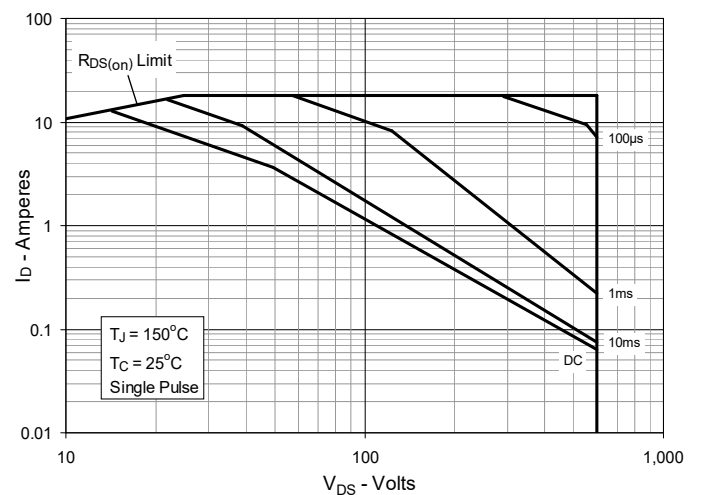
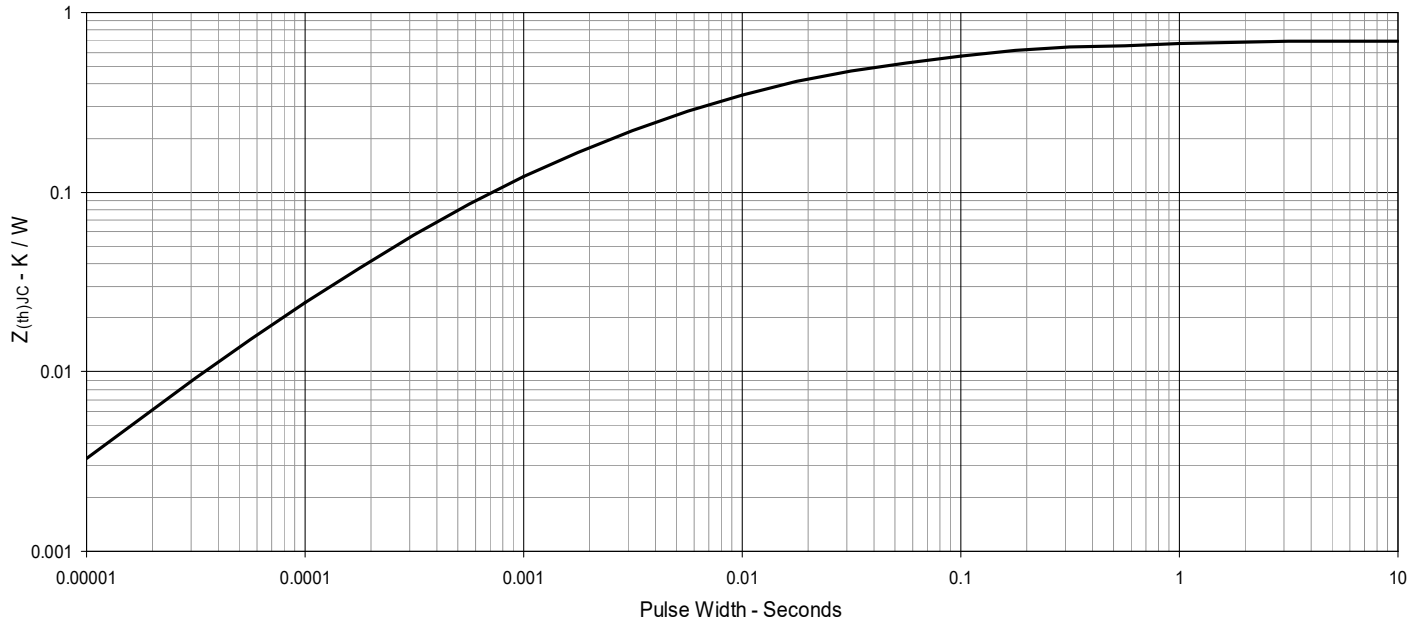
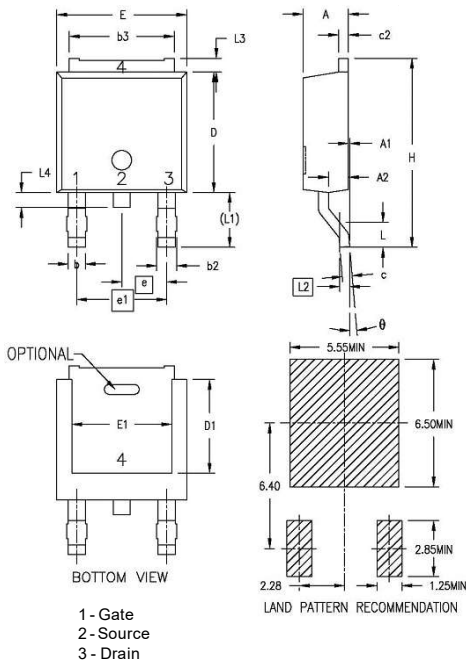
**Fig. 12. Forward-Bias Safe Operating Area**

Fig. 13. Maximum Transient Thermal Impedance



**TO-252 Outline**

SYM	INCHES		MILLIMETERS	
	MIN	MAX	MIN	MAX
A	.086	.094	2.19	2.38
A1	0	.005	0	0.12
A2	.038	.046	0.97	1.17
b	.025	.035	0.64	0.89
b2	.030	.045	0.76	1.14
b3	.200	.215	5.08	5.46
c	.018	.024	0.46	0.61
c2	.018	.023	0.46	0.58
D	.235	.245	5.97	6.22
D1	.180	.205	4.57	5.21
E	.250	.265	6.35	6.73
E1	.170	.205	4.32	5.21
e	.090 BSC		2.28 BSC	
e1	.180 BSC		4.57 BSC	
H	.370	.410	9.40	10.42
L	.055	.070	1.40	1.78
L1	.100	.115	2.54	2.92
L2	.020 BSC		0.50 BSC	
L3	.025	.040	0.64	1.02
L4	.025	.040	0.64	1.02
θ	0°	10°	0°	10°



---

Disclaimer Notice - Information furnished is believed to be accurate and reliable. However, users should independently evaluate the suitability of and test each product selected for their own applications. Littelfuse products are not designed for, and may not be used in, all applications. Read complete Disclaimer Notice at [www.littelfuse.com/disclaimer-electronics](http://www.littelfuse.com/disclaimer-electronics).

---