



Phase Control Thyristor

Types N0795YN100 to N0795YN180

Absolute Maximum Ratings

	VOLTAGE RATINGS	MAXIMUM LIMITS	UNITS
V _{DRM}	Repetitive peak off-state voltage, (note 1)	1000-1800	V
V _{DSM}	Non-repetitive peak off-state voltage, (note 1)	1100-1900	V
V _{RRM}	Repetitive peak reverse voltage, (note 1)	1000-1800	V
V _{RSM}	Non-repetitive peak reverse voltage, (note 1)	1100-1900	V

	OTHER RATINGS	MAXIMUM LIMITS	UNITS	
I _{T(AV)M}	Maximum average on-state current, T _{sink} =55°C, (note 2)	795	A	
I _{T(AV)M}	Maximum average on-state current. T _{sink} =85°C, (note 2)	540	A	
I _{T(AV)M}	Maximum average on-state current. T _{sink} =85°C, (note 3)	300	A	
I _{T(RMS)M}	Nominal RMS on-state current, T _{sink} =25°C, (note 2)	1580	A	
I _{T(d.c.)}	D.C. on-state current, T _{sink} =25°C, (note 4)	1340	A	
I _{TSM}	Peak non-repetitive surge t _p =10ms, V _{rm} =60%V _{RRM} , (note 5)	9450	A	
I _{TSM2}	Peak non-repetitive surge t _p =10ms, V _{rm} ≤10V, (note 5)	10500	A	
I ² t	I ² t capacity for fusing t _p =10ms, V _{rm} =60%V _{RRM} , (note 5)	444×10 ³	A ² s	
I ² t	I ² t capacity for fusing t _p =10ms, V _{rm} ≤10V, (note 5)	551×10 ³	A ² s	
(di/dt) _{cr}	Critical rate of rise of on-state current (note 6)	(continuous, 50Hz) (repetitive, 50Hz, 60s) (non-repetitive)	250 500 1000	A/μs
V _{RGM}	Peak reverse gate voltage	5	V	
P _{G(AV)}	Mean forward gate power	3	W	
P _{GM}	Peak forward gate power	30	W	
T _{j op}	Operating temperature range	-60 to +125	°C	
T _{stg}	Storage temperature range	-60 to +125	°C	

Notes:-

- De-rating factor of 0.13% per °C is applicable for T_j below 25°C.
- Double side cooled, single phase; 50Hz, 180° half-sinewave.
- Anode side cooled, single phase; 50Hz, 180° half-sinewave.
- Double side cooled.
- Half-sinewave, 125°C T_j initial.
- V_D=67% V_{DRM}, I_{TM}=1000A, I_{FG}=2A, t_r≤0.5μs, T_{case}=125°C.

Characteristics

	PARAMETER	MIN.	TYP.	MAX.	TEST CONDITIONS (Note 1)	UNITS
V _{TM}	Maximum peak on-state voltage	-	-	1.30	I _{TM} =785A	V
V _{TM}	Maximum peak on-state voltage	-	-	2.00	I _{TM} =2350A	V
V _{T0}	Threshold voltage	-	-	0.95		V
r _T	Slope resistance	-	-	0.45		mΩ
(dv/dt) _{cr}	Critical rate of rise of off-state voltage	1000	-	-	V _D =67% V _{DRM} , linear ramp, gate o/c	V/μs
I _{DRM}	Peak off-state current	-	-	30	Rated V _{DRM}	mA
I _{RRM}	Peak reverse current	-	-	30	Rated V _{RRM}	mA
V _{GT}	Gate trigger voltage	-	-	2.50	T _j =25°C V _D =10V, I _T =3A	V
I _{GT}	Gate trigger current	-	-	150		mA
V _{GD}	Gate non-trigger voltage	-	-	0.25	Rated V _{DRM}	V
I _H	Holding current	-	-	300	T _j =25°C	mA
t _{gd}	Gate-controlled turn-on delay time	-	-	2.0	V _D =67% V _{DRM} , I _T =2000A, di/dt=10A/μs, I _{FG} =2A, t _r =0.5μs, T _j =25°C	μs
Q _{rr}	Recovered charge	-	-	850		μC
Q _{ra}	Recovered charge, 50% Chord	-	-	750		μC
I _{rr}	Reverse recovery current	-	-	100	I _{TM} =500A, t _p =500μs, di/dt=10A/μs, V _r =100V	A
t _{rr}	Reverse recovery time	-	-	15		μs
t _q	Turn-off time	-	-	125	I _{TM} =500A, t _p =500μs, di/dt=10A/μs, V _r =50V, V _{dr} =67%V _{DRM} , dV _{dr} /dt=50V/μs	μs
R _{thJK}	Thermal resistance, junction to heatsink	-	-	0.048	Double side cooled	K/W
		-	-	0.104	Anode side cooled	K/W
		-	-	0.088	Cathode side cooled	K/W
F	Mounting force	9.0	-	11.0	Note 2.	kN
W _t	Weight	-	110	-		g

Notes:-

- 1) Unless otherwise indicated T_j=125°C.
- 2) For other clamp forces, please consult factory.

Notes on Ratings and Characteristics

1.0 Voltage Grade Table

Voltage Grade	V_{DRM} V_{RRM} V	V_{DSM} V_{RSM} V	V_D V_R DC V
10	1000	1100	750
12	1200	1300	900
14	1400	1500	1050
16	1600	1700	1200
18	1800	1900	1350

2.0 Extension of Voltage Grades

This report is applicable to other voltage grades when supply has been agreed by Sales/Production.

3.0 De-rating Factor

A blocking voltage de-rating factor of 0.13%/°C is applicable to this device for T_j below 25°C.

4.0 Repetitive dv/dt

Standard dv/dt is 1000V/μs.

5.0 Snubber Components

When selecting snubber components, care must be taken not to use excessively large values of snubber capacitor or excessively small values of snubber resistor. Such excessive component values may lead to device damage due to the large resultant values of snubber discharge current. If required, please consult the factory for assistance.

6.0 Rate of rise of on-state current

The maximum un-primed rate of rise of on-state current must not exceed 1000A/μs at any time during turn-on on a non-repetitive basis. For repetitive performance, the on-state rate of rise of current must not exceed 500A/μs at any time during turn-on. Note that these values of rate of rise of current apply to the total device current including that from any local snubber network.

7.0 Gate Drive

The nominal requirement for a typical gate drive is illustrated below. An open circuit voltage of at least 30V is assumed. This gate drive must be applied when using the full di/dt capability of the device.

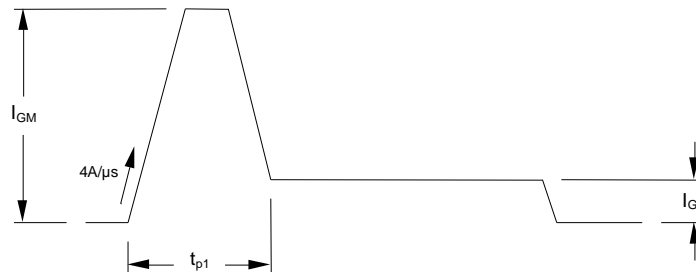

The magnitude of I_{GM} should be between five and ten times I_{GT} , which is shown on page 2. Its duration (t_{p1}) should be 20μs or sufficient to allow the anode current to reach ten times I_L , whichever is greater. Otherwise, an increase in pulse current could be needed to supply the necessary charge to trigger. The 'back-porch' current I_G should remain flowing for the same duration as the anode current and have a magnitude in the order of 1.5 times I_{GT} .

8.0 Computer Modelling Parameters

8.1 Device Dissipation Calculations

$$I_{AV} = \frac{-V_{T0} + \sqrt{V_{T0}^2 + 4 \cdot ff^2 \cdot r_T \cdot W_{AV}}}{2 \cdot ff^2 \cdot r_T}$$

and:

$$W_{AV} = \frac{\Delta T}{R_{th}}$$

$$\Delta T = T_{j\max} - T_K$$

 Where $V_{T0}=0.95V$, $r_T=0.45m\Omega$,

 R_{th} = Supplementary thermal impedance, see table below and

 ff = Form factor, see table below.

Supplementary Thermal Impedance							
Conduction Angle	30°	60°	90°	120°	180°	270°	d.c.
Square wave Double Side Cooled	0.0721	0.0590	0.0529	0.0494	0.0455	0.0423	0.0400
Square wave Anode Side Cooled	0.1192	0.1058	0.1000	0.0968	0.0932	0.0901	0.0880
Sine wave Double Side Cooled	0.0550	0.0455	0.0429	0.0414	0.0400		
Sine wave Anode Side Cooled	0.1007	0.0922	0.0901	0.0890	0.0880		

Form Factors							
Conduction Angle	30°	60°	90°	120°	180°	270°	d.c.
Square wave	3.46	2.45	2	1.73	1.41	1.15	1
Sine wave	3.98	2.78	2.22	1.88	1.57		

8.2 Calculating V_T using ABCD Coefficients

 The on-state characteristic I_T vs. V_T , on page 7 is represented in two ways;

- (i) the well established V_{T0} and r_T tangent used for rating purposes and
- (ii) a set of constants A, B, C, D, forming the coefficients of the representative equation for V_T in terms of I_T given below:

$$V_T = A + B \cdot \ln(I_T) + C \cdot I_T + D \cdot \sqrt{I_T}$$

 The constants, derived by curve fitting software, are given below for both hot and cold characteristics. The resulting values for V_T agree with the true device characteristic over a current range, which is limited to that plotted.

25°C Coefficients		125°C Coefficients	
A	1.002653	A	0.7805236
B	0.04167941	B	0.02060617
C	2.853771×10^{-4}	C	4.092687×10^{-4}
D	-1.458858×10^{-3}	D	2.110089×10^{-3}

8.3 D.C. Thermal Impedance Calculation

$$r_t = \sum_{p=1}^{p=n} r_p \cdot \left(1 - e^{-\frac{t}{\tau_p}} \right)$$

Where $p = 1$ to n , n is the number of terms in the series and:

t = Duration of heating pulse in seconds.

r_t = Thermal resistance at time t .

r_p = Amplitude of p_{th} term.

τ_p = Time Constant of r_{th} term.

The coefficients for this device are shown in the tables below:

D.C. Double Side Cooled						
Term	1	2	3	4	5	6
r_p	0.01423	1.906×10^{-2}	3.576×10^{-3}	2.535×10^{-3}	4.666×10^{-5}	6.479×10^{-4}
τ_p	0.265	0.05901	0.03499	1.252×10^{-3}	1.0×10^{-6}	2.488×10^{-4}

D.C. Anode Side Cooled						
Term	1	2	3	4	5	6
r_p	0.04804	1.789×10^{-3}	1.342×10^{-2}	2.147×10^{-2}	1.374×10^{-3}	1.945×10^{-3}
τ_p	2.651	0.4195	0.2622	0.05451	2.585×10^{-3}	5.847×10^{-4}

D.C. Cathode Side Cooled						
Term	1	2	3	4	5	6
r_p	0.03216	1.306×10^{-2}	2.934×10^{-3}	2.064×10^{-2}	1.493×10^{-3}	1.786×10^{-3}
τ_p	2.647	0.2831	0.1455	0.05284	2.255×10^{-3}	5.519×10^{-4}

9.0 Reverse recovery ratings

(i) Q_{rr} is based on 50% I_{RM} chord as shown in Diagram 1

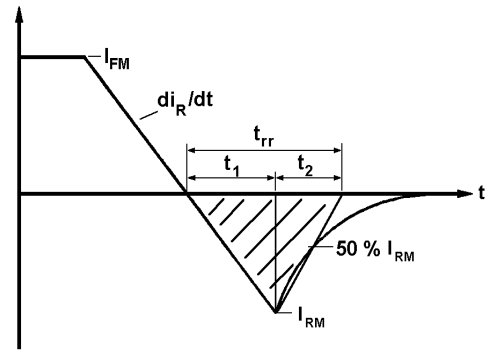

Diagram 1

(ii) Q_{rr} is based on a $150\mu s$ integration time i.e.

$$Q_{rr} = \int_0^{150\mu s} i_{rr} \cdot dt$$

(iii) $K \text{ Factor} = \frac{t_1}{t_2}$

Curves

Figure 1 – On-state characteristics of Limit device

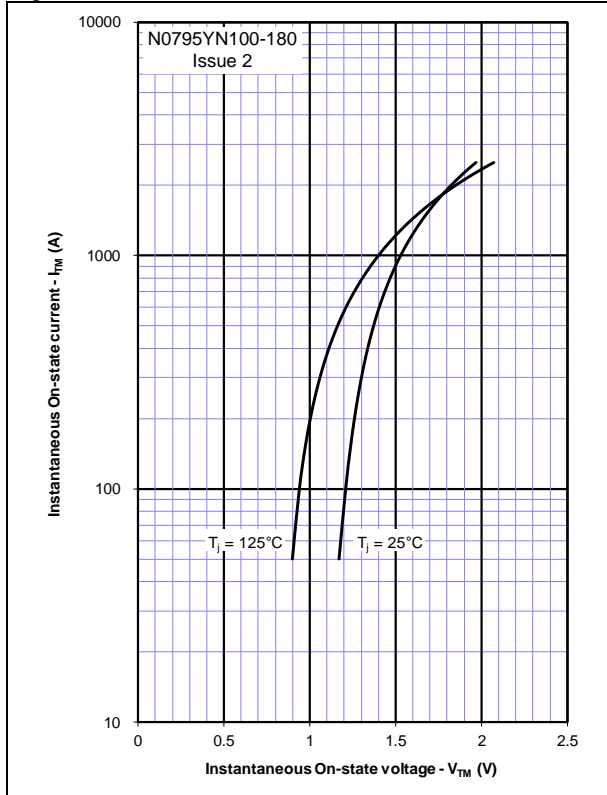

Figure 2 – Transient thermal impedance junction to case

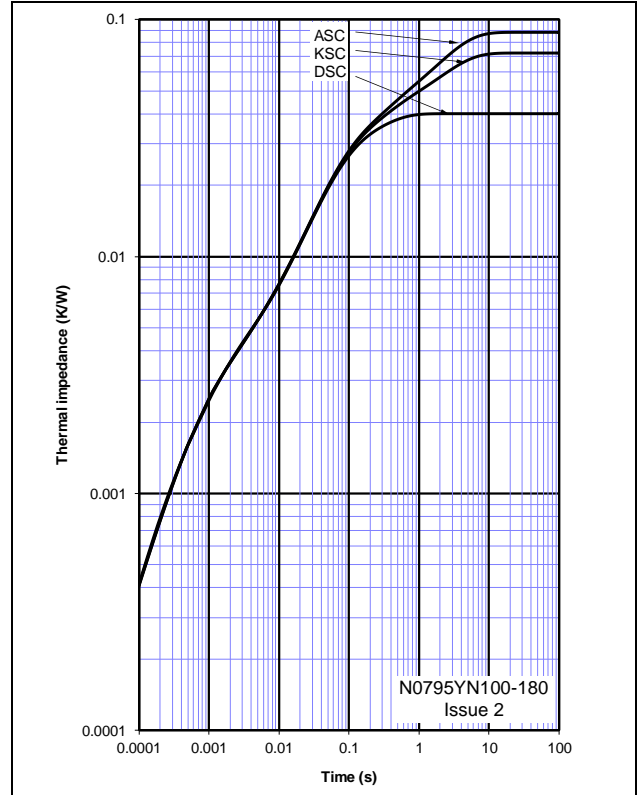

Figure 3 – Gate Characteristics – Trigger limits

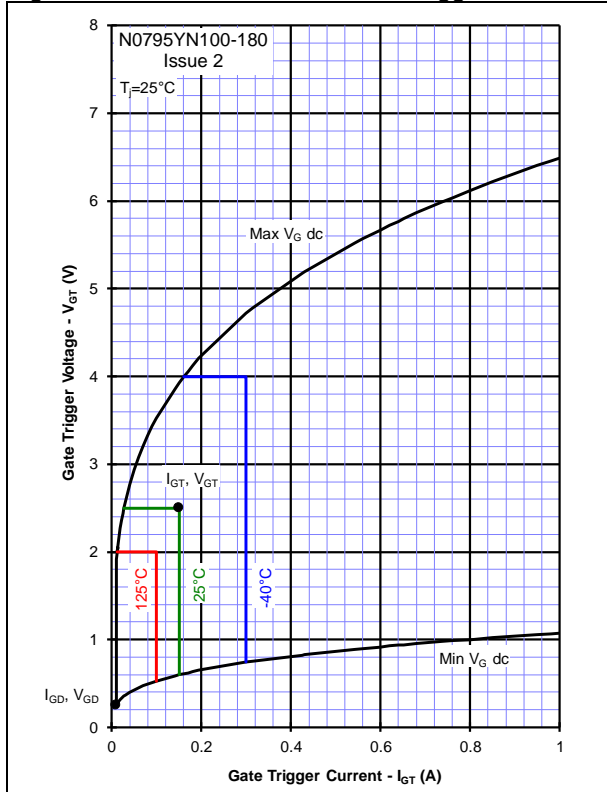

Figure 4 – Gate Characteristics – Power Curves

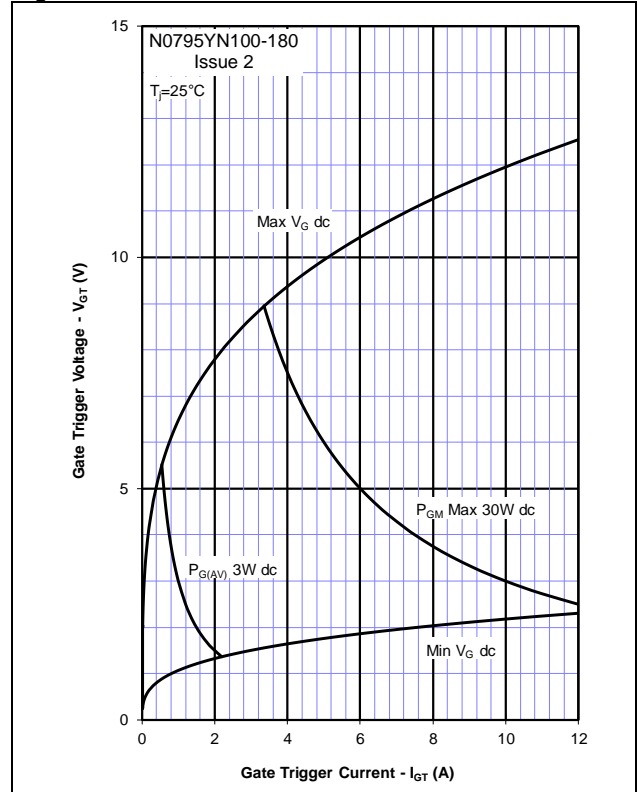

Figure 5 – Total Recovered Charge, Q_{rr}

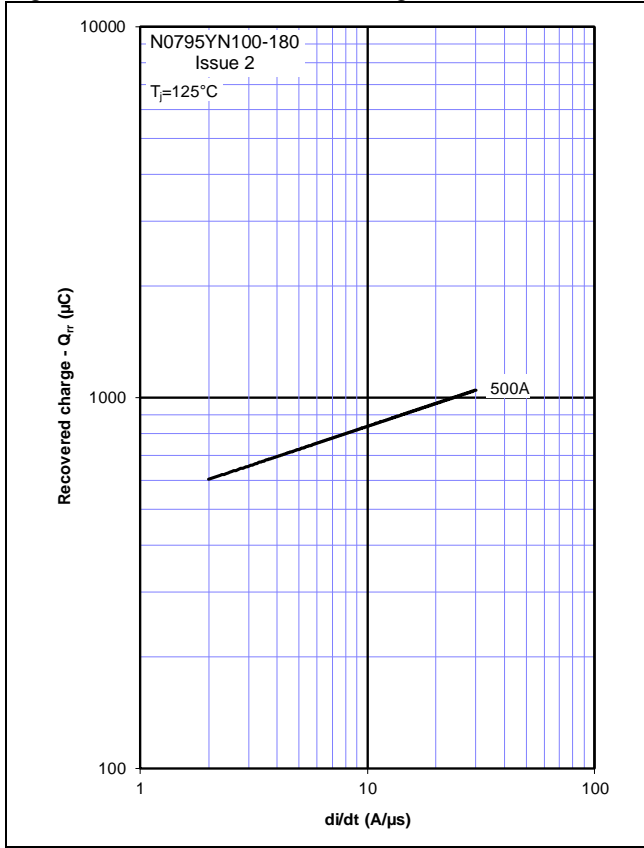

Figure 6 – Recovered Charge, Q_{ra} (50% chord)

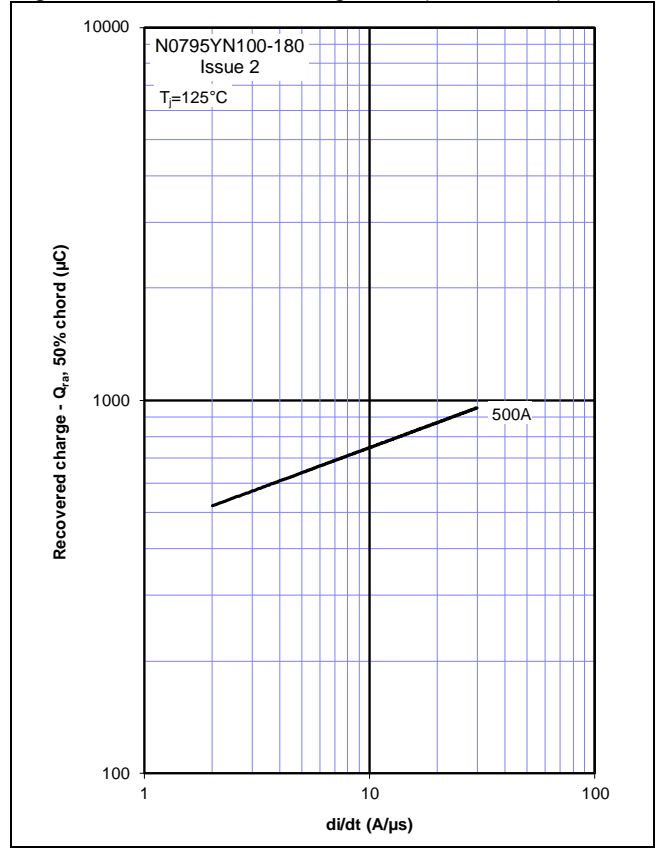

Figure 7 – Peak Reverse Recovery Current, I_{rm}

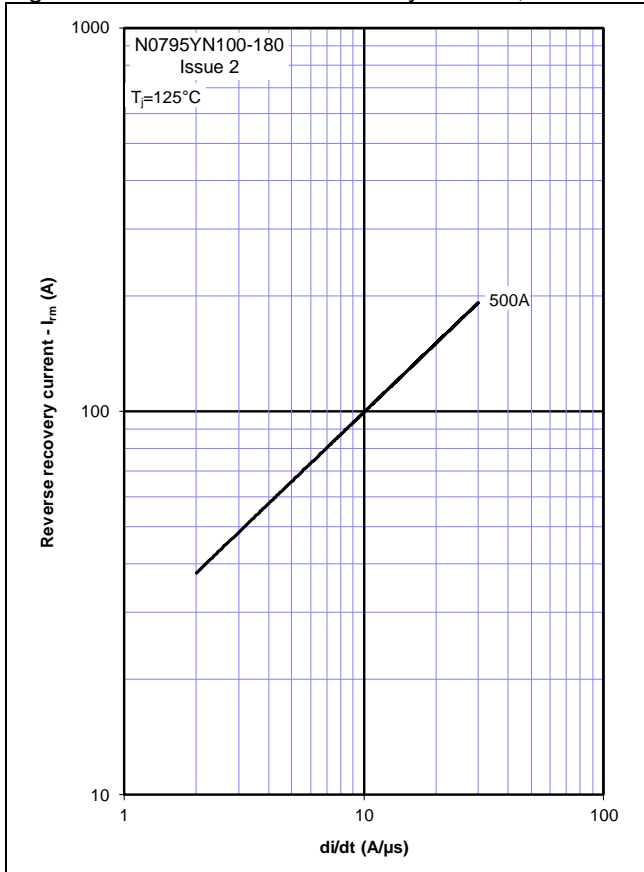

Figure 8 – Maximum Recovery Time, t_{rr} (50% chord)

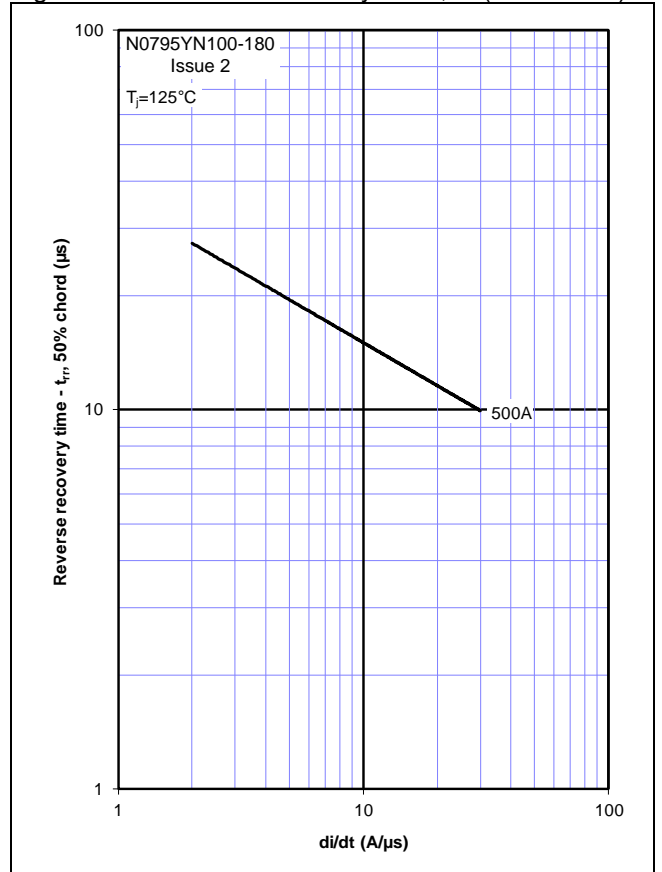

Figure 9 – On-state current vs. Power dissipation – Double Side Cooled (Sine wave)

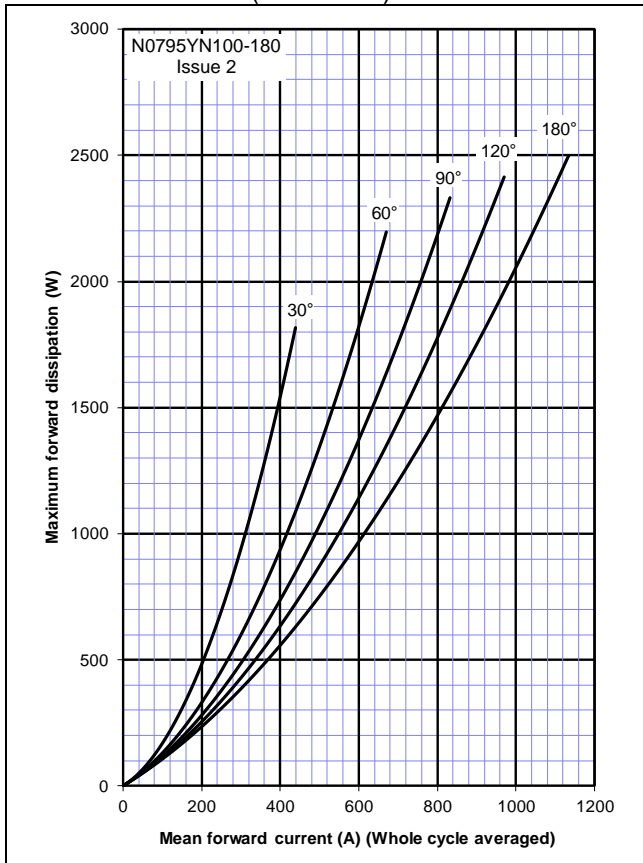

Figure 10 – On-state current vs. Case temperature – Double Side Cooled (Sine wave)

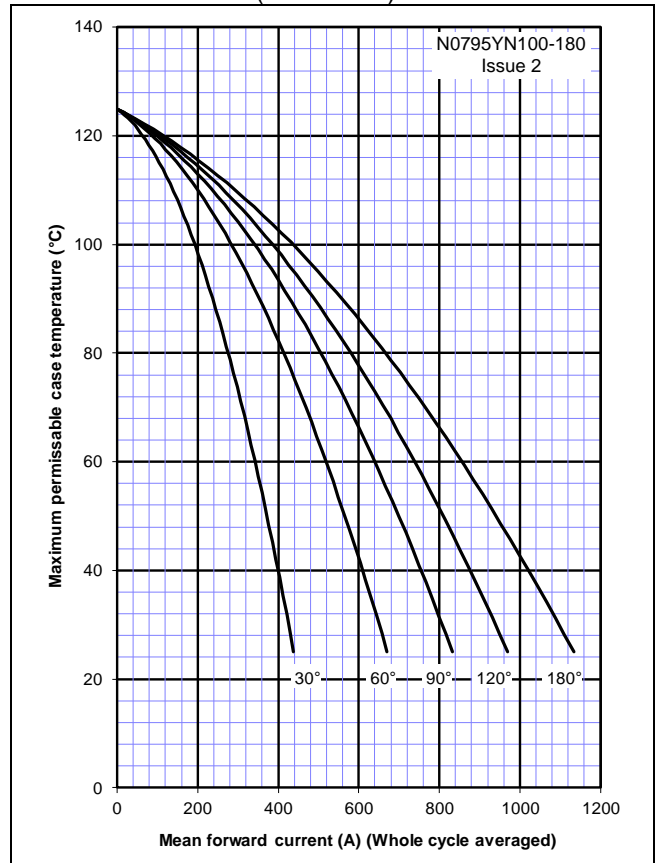

Figure 11 – On-state current vs. Power dissipation – Double Side Cooled (Square wave)

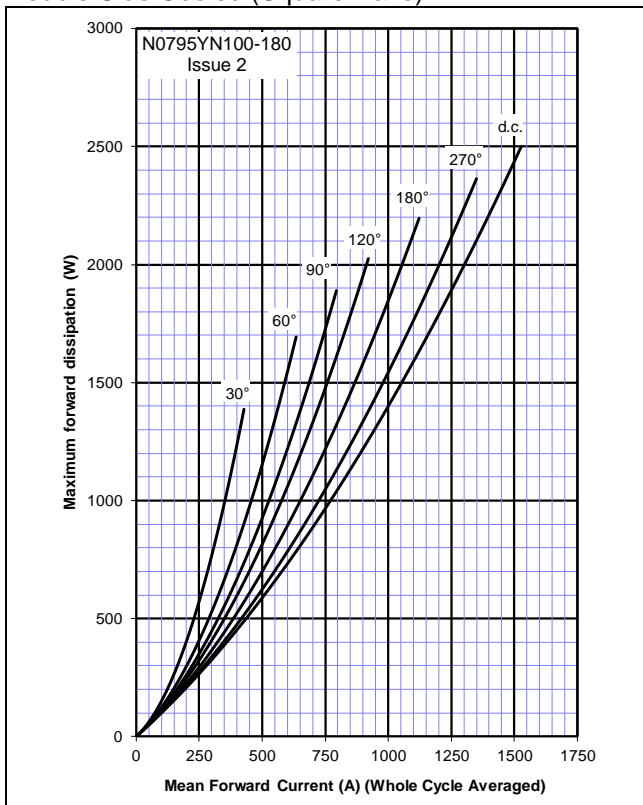

Figure 12 – On-state current vs. Case temperature – Double Side Cooled (Square wave)

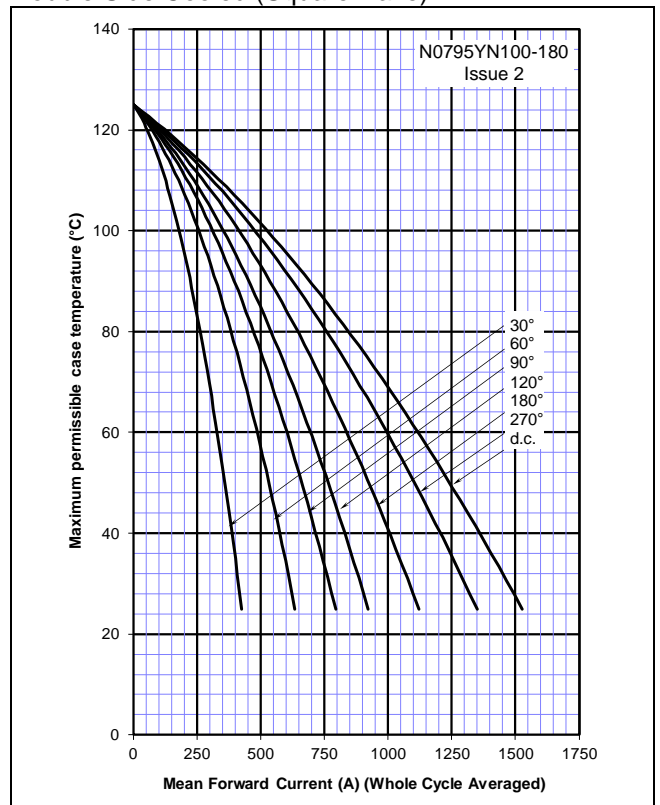

Figure 13 – On-state current vs. Power dissipation – Single Side Cooled (Sine wave)

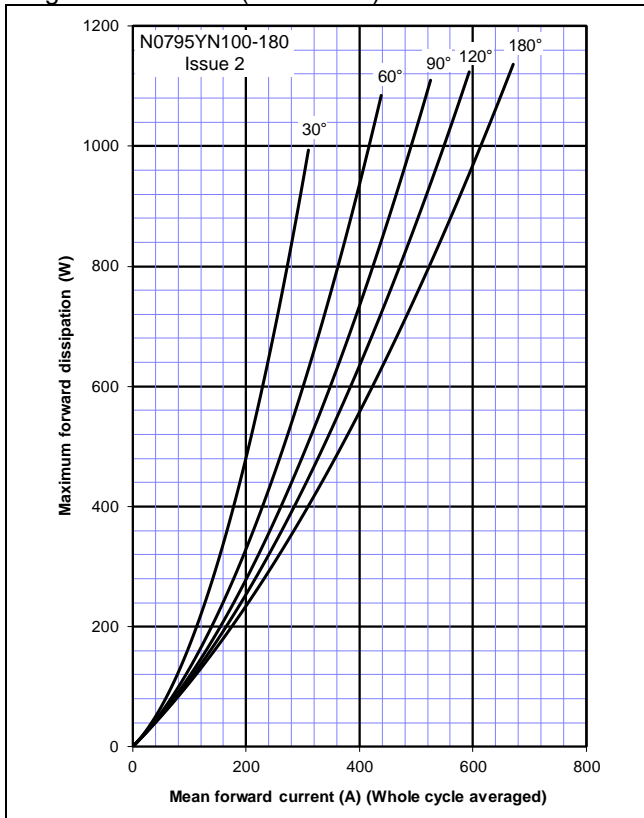

Figure 14 – On-state current vs. Case temperature – Single Side Cooled (Sine wave)

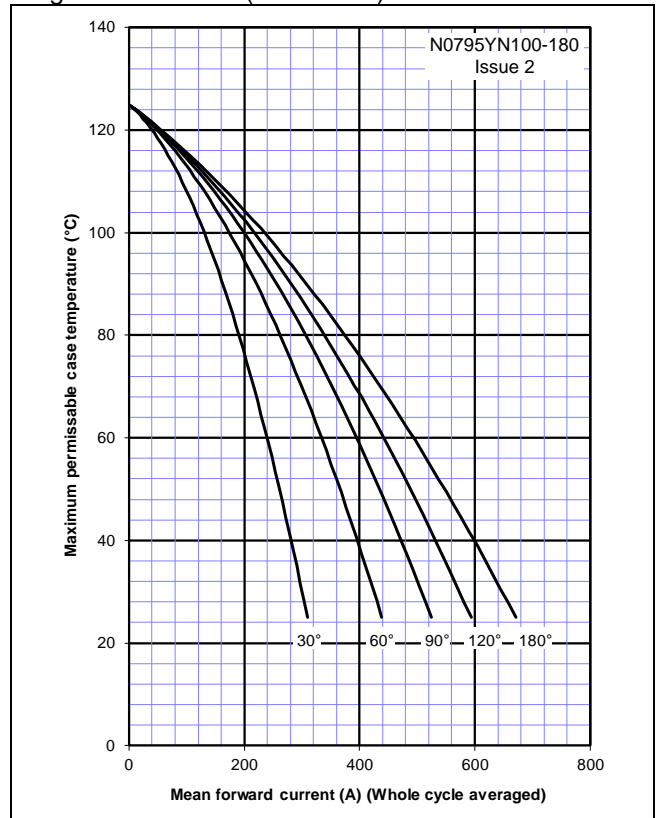

Figure 15 – On-state current vs. Power dissipation – Single Side Cooled (Square wave)

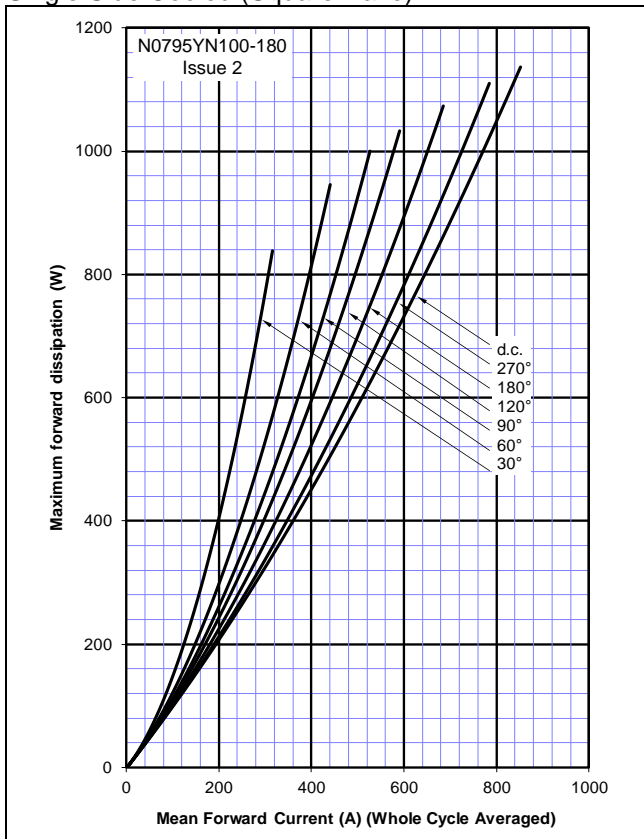

Figure 16 – On-state current vs. Case temperature – Single Side Cooled (Square wave)

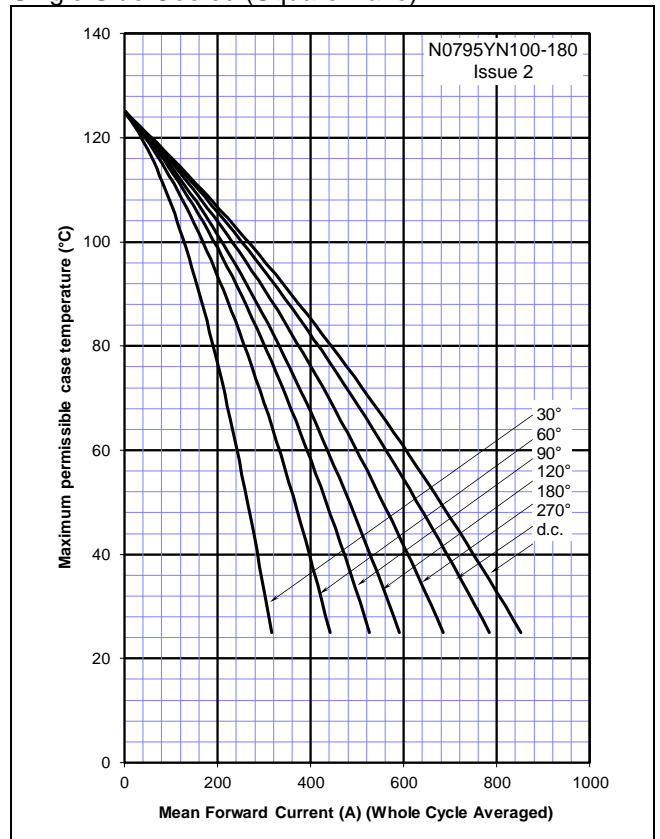
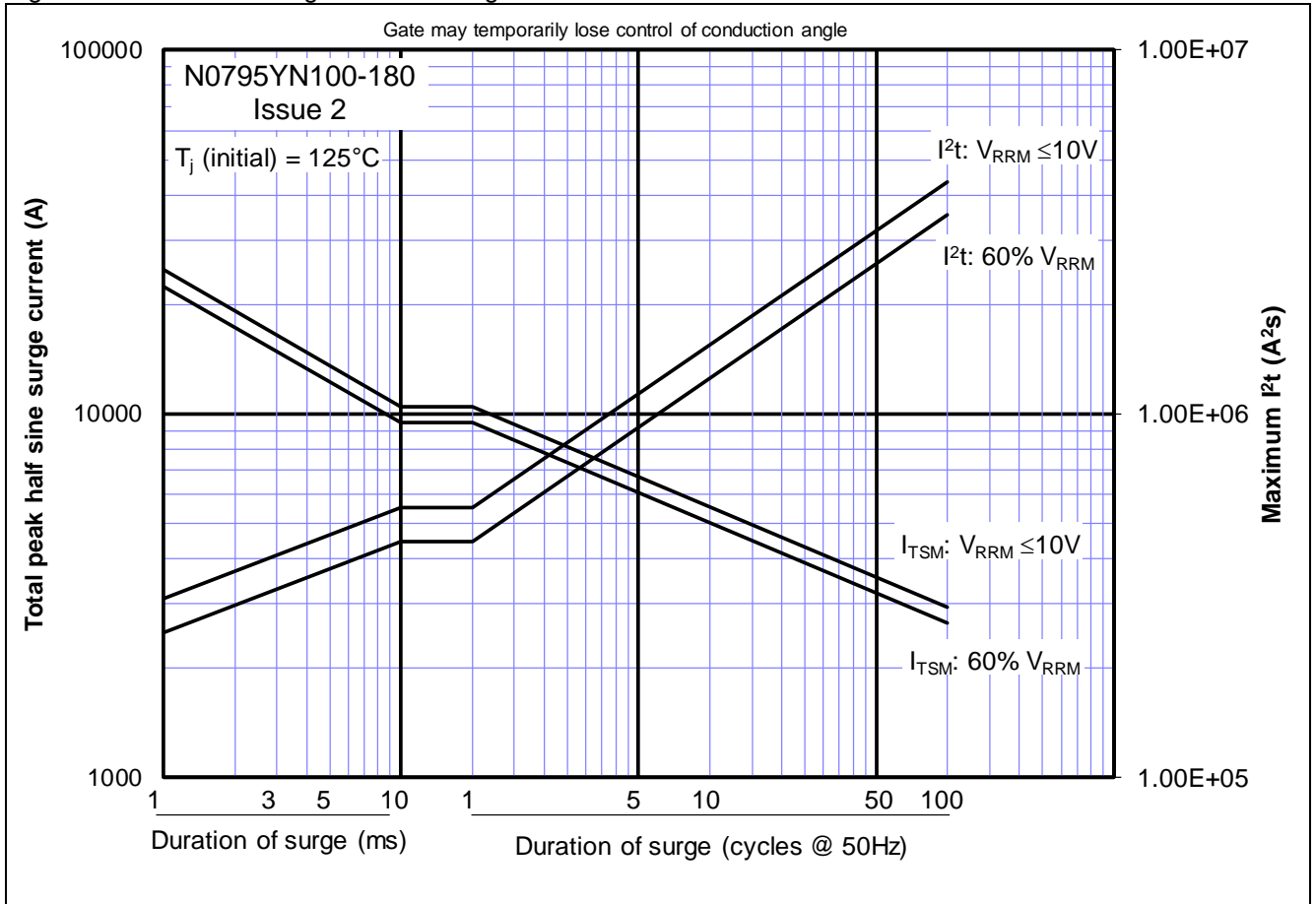
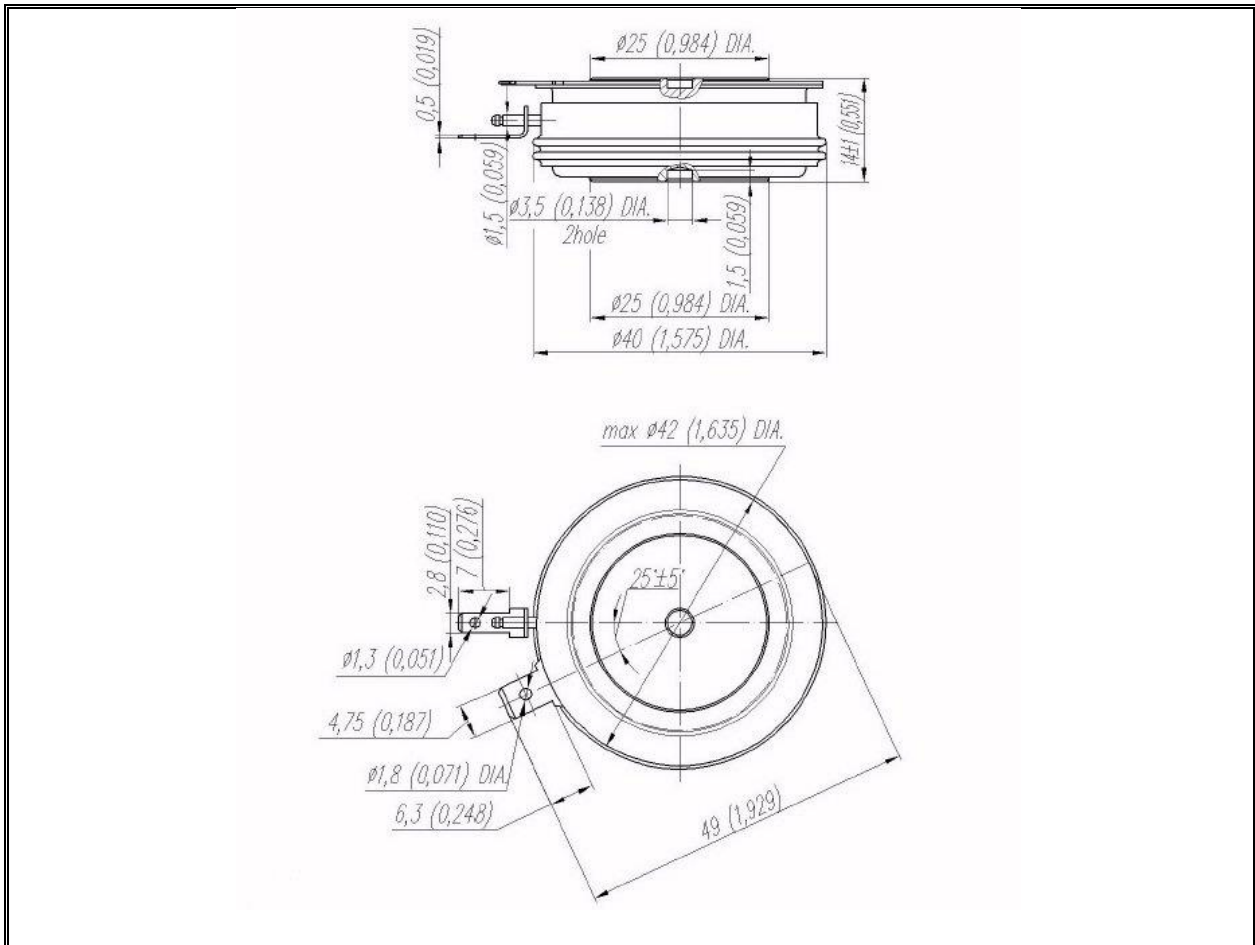

Figure 17 – Maximum surge and I^2t Ratings



Outline Drawing & Ordering Information

ORDERING INFORMATION

(Please quote 10 digit code as below)

N0795	YN	◆◆	0
Fixed Type Code	Fixed outline code	Voltage code $V_{DRM}/100$ 10-18	Fixed turn-off time code

 Order code: N0795YN180 – 1800V V_{DRM} , V_{RRM} , 14mm clamp height capsule.

IXYS UK Westcode Ltd
 Langley Park Way, Langley Park, Chippenham, Wiltshire, SN15 1GE.
 Tel: +44 (0)1249 444524
 Fax: +44 (0)1249 659448
 E-mail: sales@ixysuk.com



IXYS Long Beach
 IXYS Long Beach, Inc
 2500 Mira Mar Ave, Long Beach CA 90815
 Tel: +1 (562) 296 6584
 Fax: +1 (562) 296 6585
 E-mail: service@ixyslongbeach.com

www.littelfuse.com
www.littelfuse.com/products/power-semiconductors/high-power

The information contained herein is confidential and is protected by Copyright. The information may not be used or disclosed except with the written permission of and in the manner permitted by the proprietors IXYS UK Westcode Ltd.

© IXYS UK Westcode Ltd.

In the interest of product improvement, IXYS UK Westcode Ltd reserves the right to change specifications at any time without prior notice.

Devices with a suffix code (2-letter, 3-letter or letter/digit/letter combination) added to their generic code are not necessarily subject to the conditions and limits contained in this report.

Disclaimer Notice – Information furnished is believed to be accurate and reliable. However, users should independently evaluate the suitability of and test each product selected for their own applications. Littelfuse products are not designed for, and may not be used in, all applications. Read complete Disclaimer Notice at www.littelfuse.com/disclaimer-electronics.