

443E Series Fuse



Description

The 443E Series is a Nano²®, 250 V fuse. It is a surface mount Universal Modular Fuse (UMF) that complies with IEC 60127-4. It is RoHS-compliant and fully compatible with lead-free solder alloy and higher temperature profiles associated with lead-free assembly.

Features

- 250 VAC/VDC voltage rating with 200 A interrupting rating
- Slo-Blo® Fuse
- RoHS-compliant
- Fully compatible with leadfree solder alloys and higher temperature profiles associated with lead-free assembly



Benefits

- Avoids nuisance opening due to high inrush and surge current inherent in the system
- Suits high voltage applications requiring high interrupting current

Applications

- AC/DC power adaptor
- Telecom equipment system power
- Portable system built-in AC/DC converter

Agency Approvals

AGENCY	AGENCY FILE NUMBER	AMPERE RANGE
	E242325	1.25 A
	40046623	1.25 A
	CQC17012176681	1.25 A

Electrical Characteristics

% of Ampere Rating	Ampere Rating	Opening Time at 25°C
100%	1.25 A	4 hours Minimum
200%	1.25 A	120 secs Maximum

Additional Information



Datasheet





Resources



Samples

Electrical Specifications by Item

Ampere Rating (A)	Amp Code	Max. Voltage Rating (V)	Interrupting Rating (AC/DC)	Nominal Cold Resistance (Ohms) ¹	Nominal Melting I ² t (A ² Sec.) ²	Nominal Voltage Drop (mV)	Nominal Power Dissipation at Rated Current (W)	Agency Approval ³		
										
1.25	1.25	250	200A @ 250VAC/ 200A @ 250VDC*	0.100	3.97	165	0.456	x	x	x

Note:

1. Nominal Cold Resistance measured at less than 10% of rated current at 23° C.
 2. Nominal Melting I²t is measured at 10 the Ampere Rating (I_n)
 3. Agency Approval Table key: X = Approved or Certified, P = Pending and Blank = Not Approved
 4. Have special electrical characteristic needs? Contact Littelfuse to learn more about application specific options
- * Based on internal LF testing only

Temperature Re-rating Curve

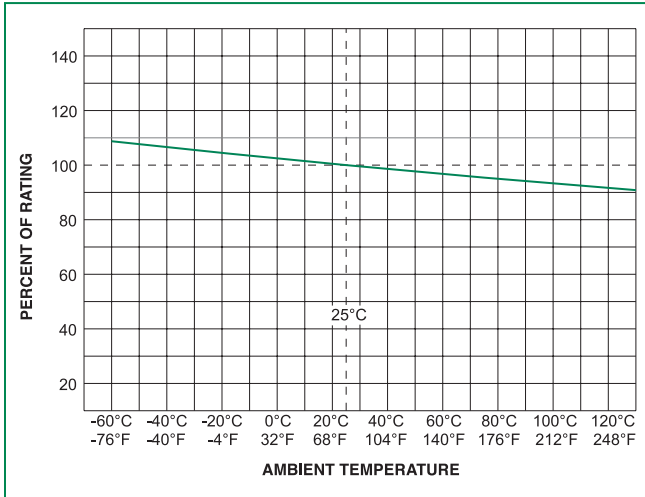

Note:
Re-rating depicted in this curve is in addition to the standard re-rating of 25% for continuous operation.

Average Time Current Curves

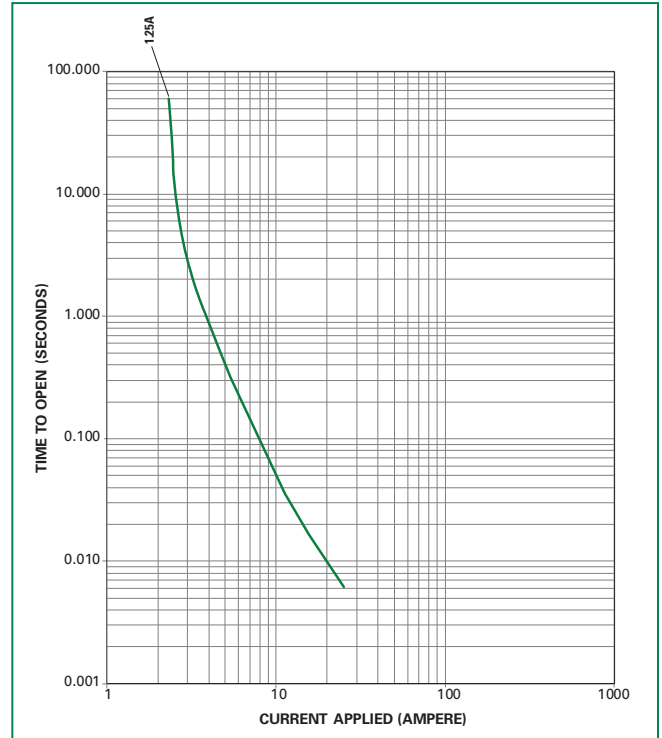

Soldering Parameters

Reflow Condition		Pb – free assembly
Pre Heat	- Temperature Min ($T_{s(min)}$)	150° C
	- Temperature Max ($T_{s(max)}$)	200° C
	- Time (Min to Max) (t_s)	60 – 180 seconds
Average Ramp-up Rate (Liquidus Temp (T_L) to peak)		5° C/second max.
$T_{s(max)}$ to T_L - Ramp-up Rate		5° C/second max.
Reflow	- Temperature (T_L) (Liquidus)	217° C
	- Temperature (t_L)	60 – 150 seconds
Peak Temperature (T_p)		260 ^{+0/-5} ° C
Time within 5°C of actual peak Temperature (t_p)		20 – 40 seconds
Ramp-down Rate		5° C/second max.
Time 25°C to peak Temperature (T_p)		8 minutes max.
Do not exceed		260° C

Wave soldering	260° C Peak Temperature, 3 seconds max.
----------------	---

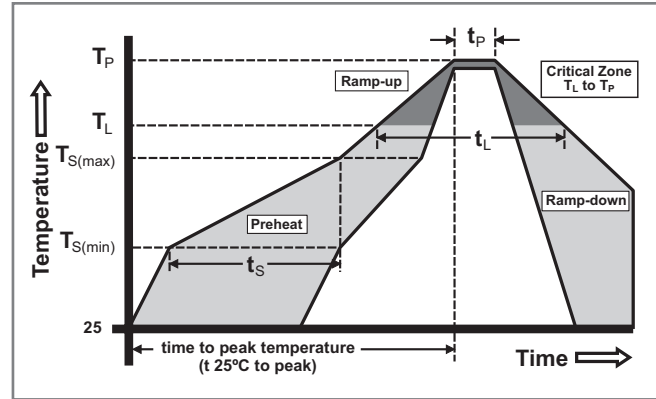

Product Characteristics

Materials	Body: Ceramic Cap: Silver Plated Brass
Product Marking	Voltage rating, Ampere rating, T-Characteristic, "T" and Brand
Temperature Humidity Bias	MIL-STD-202, Method 103, (85° C, 85%RH with 10% hold current)
Solderability	MIL-STD-202, Method 208 (95% coverage)
Resistance to Soldering Heat	MIL-STD-202, Method 210
Pulse Test	IEC 60127-1; 9.5 (25° C +/-5° C, pulse 100% rated current)
Terminal Strength Test	MIL-STD-202, Method 211, Test Condition A (5N force to the side for 60sec)
Endurance Test	IEC 60127-1; 9.4 (25° C +/-5° C, 100% rated current for 1 hour, stop current for 15 mins. 100 cycles. Test for voltage drop to determine maximum power dissipation)
Operating Temperature	-60° C to 130° C
Temperature Cycling	JESDD22 - A104 (-40° C to 125° C)
High Frequency Vibration	MIL-STD-202, Method 204 (55Hz – 2Hz, 10G)
Low Temperature Storage	MIL-STD-202, Method 108 (-40° C for 1000 hours)
High Temperature Storage	MIL-STD-202, Method 108 (125° C for 1000 hours)
Mechanical Shock	MIL-STD-202, Method 213, (50 G's peak for 11 milliseconds, halfsine waveform/10 – 55 Hz)
High Temperature Operating Life Test	JESD 22 - A108 (125° C rated current at any voltage <= to rated voltage); 1000H duration

Dimensions

All dimensions in mm (in)

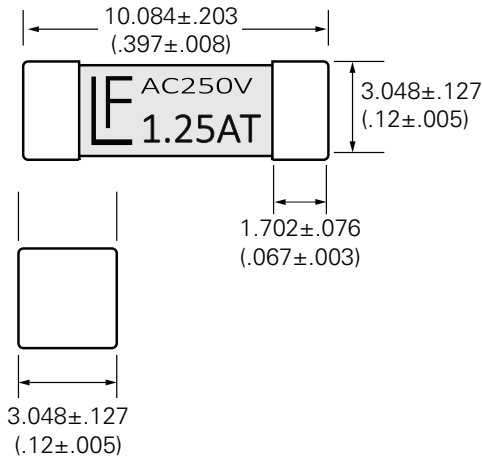

Recommended Pad Layout

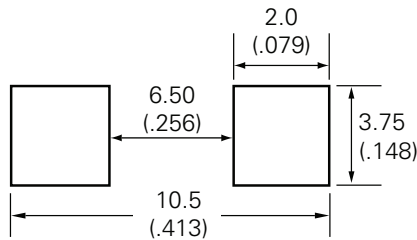

Part Numbering System

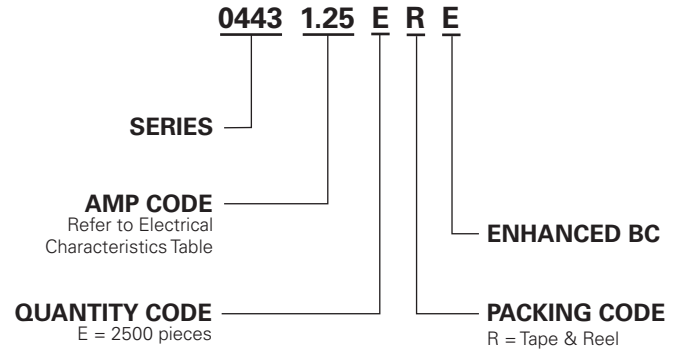

Packaging

Packaging Option	Form Factor	Packaging Specification	Quantity	Quantity & Packaging Code
24mm Tape and Reel	Surface Mount	EIA-RS 481-2 (IEC 60286-3)	2500	ERE

Disclaimer Notice - Information furnished is believed to be accurate and reliable. However, users should independently evaluate the suitability of and test each product selected for their own applications. Littelfuse products are not designed for, and may not be used in, all applications. Read complete Disclaimer Notice at www.littelfuse.com/disclaimer-electronics.