

## Automotive High Temperature SMD Series



### Applications

- Automotive and Industrial Transportation
- Infotainment/Telematics
- Climate Control Systems
- Body Electronics
- Sensor Protection
- ADAS (Advanced Driver Assistance)
- Auto Lighting
- Security and Communication Systems

### Additional Information



Datasheet



Resources



Samples

### Description

This Automotive High Temperature SMD is the first miniature high temperature PPTC series from Littelfuse with AEC-Q200 qualification for automotive applications and it provides surface mount overcurrent protection for applications where space is a prime concern and resettable protection is desired.

### Features

- Meets applicable automotive industry standards
- Compatible with high volume electronics assembly
- Smaller footprint
- High operating temperature -40°C~125°C
- Resettable solution against overcurrent and short circuit
- AEC-Q200 qualified
- RoHS compliant, halogen-free, and lead-free
- Surface-mount form factor

### Benefits

- Expertise from the world's leading resettable overcurrent protection manufacturer
- Provides wider range of form factors to enhance design flexibility
- Meets ever-increasing demand for compact and space saving designs due to more electronics content in vehicle
- Restores system operation after reset when fault condition is removed, thus provides safety and protection
- Able to meet most stringent requirements for the extreme harsh automotive environment
- Suitable for standard PCB assembly to enable automated mass production

### Electrical Characteristics

Part Number	Size	$I_H$	$I_T$	$V_{MAX}$	$I_{MAX}$	$P_{D Typ}$	Max Time-to-trip		$R_{MIN}$	$R_{1MAX}$
		(A)	(A)	(V <sub>DC</sub> )	(A)	(W)	(A)	(s)	(Ω)	(Ω)
<b>Automotive High Temperature SMD – 16-30V</b>										
picoASMDCH005F	0805	0.05	0.18	16	40	0.60	0.50	0.08	3.50	38.00
picoASMDCH010F	0805	0.10	0.60	16	40	1.00	2.50	1.50	1.00	10.00
picoASMDCH020F	0805	0.2	0.7	16	40	0.90	8.00	0.10	0.75	3.40
nanoASMDCH016F	1206	0.16	0.80	30	20	0.90	8.00	0.10	0.70	6.00
nanoASMDCH035F	1206	0.35	0.95	16	50	1.00	3.50	0.20	0.20	1.60
nanoASMDCH035F/30	1206	0.35	1.75	30	20	1.20	8.00	0.10	0.40	2.20
nanoASMDCH050F/24	1206	0.50	2.50	24	20	1.70	8.00	0.10	0.20	1.60
miniASMDCH050F	1812	0.50	1.60	30	20	1.20	8.00	0.10	0.20	1.35

#### Notes:

- $I_H$  : Hold current: maximum current device will pass without interruption in 25°C, unless otherwise specified.  
 $I_T$  : Trip current: minimum current that will switch the device from low-resistance to high-resistance in 25°C still air, unless otherwise specified.  
 $V_{MAX}$  : Maximum voltage device can withstand without damage at rated current.  
 $I_{MAX}$  : Maximum fault current device can withstand without damage at rated voltage.  
 $P_D$  : Power dissipated from device when in the tripped state in 25°C still air, unless otherwise specified.  
 $R_{MIN}$  : Minimum resistance of device as supplied at 25°C, unless otherwise specified.  
 $R_{1MAX}$  : Maximum resistance of device when measured one hour post reflow at 25°C unless otherwise specified.  
 \* Electrical characteristics determined at 25°C.

**Temperature Derating**

Maximum Ambient Temperature											
Part Number	-40°C	-20°C	0°C	20°C	25°C	40°C	50°C	60°C	70°C	85°C	125°C
Hold Current (A)											
Automotive High Temperature SMD – 16-30V											
picoASMDCH005F	0.075	0.069	0.060	0.056	0.050	0.048	0.046	0.042	0.040	0.035	0.022
picoASMDCH010F	0.150	0.130	0.115	0.103	0.100	0.090	0.084	0.078	0.072	0.063	0.040
picoASMDCH020F	0.300	0.270	0.240	0.210	0.200	0.180	0.160	0.150	0.130	0.110	0.050
nanoASMDCH016F	0.250	0.210	0.190	0.170	0.160	0.140	0.130	0.120	0.110	0.090	0.050
nanoASMDCH035F	0.540	0.480	0.430	0.370	0.350	0.320	0.290	0.260	0.240	0.200	0.100
nanoASMDCH035F/30	0.510	0.460	0.410	0.360	0.350	0.310	0.290	0.260	0.240	0.200	0.100
nanoASMDCH050F/24	0.730	0.660	0.580	0.500	0.500	0.450	0.420	0.390	0.350	0.310	0.170
miniASMDCH050F	0.750	0.680	0.600	0.520	0.500	0.450	0.410	0.400	0.330	0.280	0.120

**Temperature Derating Curve**

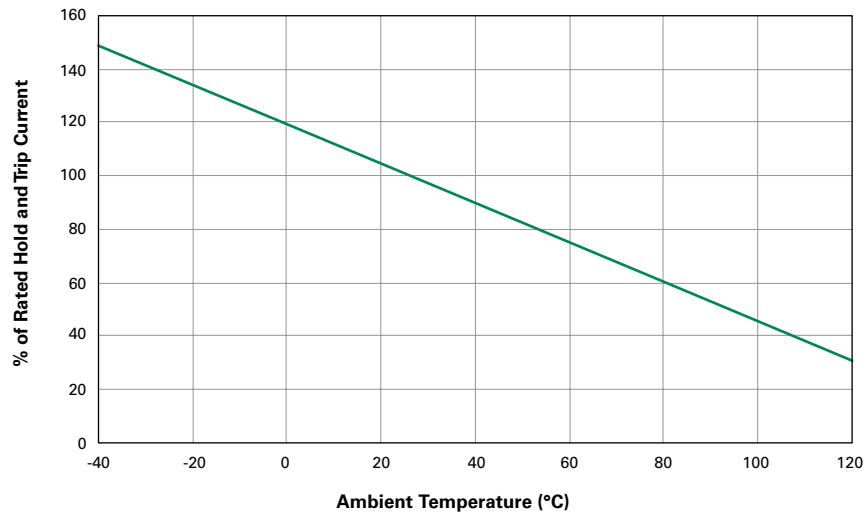

**Typical Time-to-Trip Curves at 25°C**

- A** = picoASMDCH005F
- B** = picoASMDCH010F
- C** = picoASMDCH020F
- D** = nanoASMDCH016F
- E** = nanoASMDCH035F
- F** = nanoASMDCH035F/30
- G** = nanoASMDCH050F/24
- H** = miniASMDCH050F

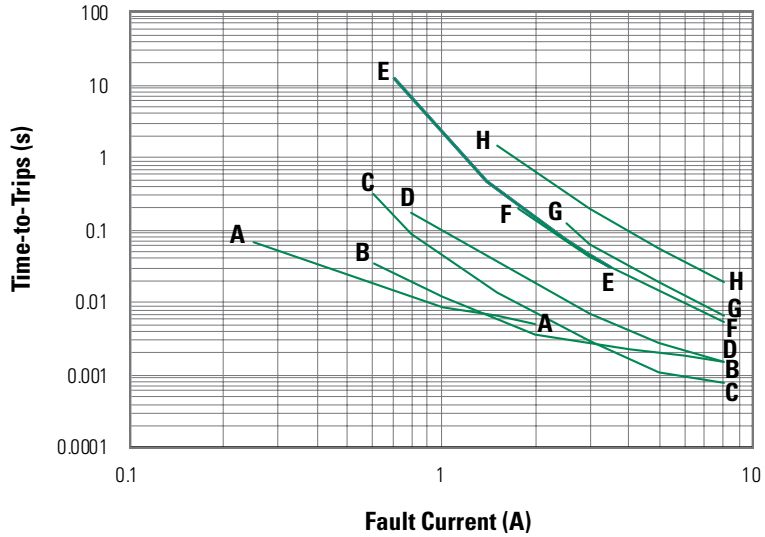

**Physical Specifications**

<b>Terminal Pad Material</b>	100% Matte Tin with Nickel Underplate
<b>Soldering Characteristics</b>	Solderability per ANSI-J-STD-002 Category 3
<b>Solder Heat Withstand</b>	per IEC-STD 68-2-20, Test Tb, Section 5, Method 1a
<b>Flammability Resistance</b>	per IEC 695-2-2 Needle Flame Test for 20 seconds
<b>Recommended Storage Conditions</b>	40°C max, 70% RH max; Devices May Not Meet Specified Ratings if Storage Conditions are Exceeded
<b>Operation Temperature</b>	-40°C~125°C

Note: See PS400 for other physical specifications.

**Environmental Specifications**

Test	Conditions	Resistance Change
<b>Passive Aging</b>	60°C, 1000 hrs, 85°C, 1000 hrs	±3% Typical, ±5% Typical
<b>Humidity Aging</b>	85°C, 85% R.H., 100 hrs	±1.2% Typical
<b>Thermal Shock</b>	125°C, -40°C 10 times	-33% Typical
<b>Solvent Resistance</b>	Freon Trichloroethane Hydrocarbons	No change No change No change

Note: See PS400 for other environmental specifications.

<b>Moisture Resistance Level</b>	Level 2a, J-STD-020
<b>Storage Conditions</b>	40°C max, 70% RH max; devices should remain in original sealed bags prior to use. Devices may not meet specified values if these storage conditions are exceeded.

**Dimensions**

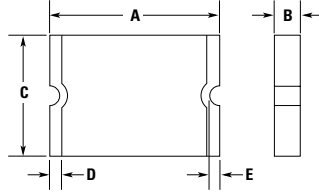

**Dimensions**

Part Number	Dimensions in Millimeters (Inches)									
	A		B		C		D		E	
	Min	Max	Min	Max	Min	Max	Min	Max	Min	Max
<b>Automotive High Temperature SMD – 16-30V</b>										
picoASMDCH005F	2.00 (0.079)	2.20 (0.087)	0.40 (0.016)	0.80 (0.031)	1.30 (0.051)	1.50 (0.059)	0.25 (0.010)	0.75 (0.030)	0.08 (0.003)	-
picoASMDCH010F	2.00 (0.079)	2.20 (0.087)	0.40 (0.016)	0.80 (0.310)	1.30 (0.051)	1.50 (0.059)	0.25 (0.010)	0.75 (0.030)	0.076 (0.003)	-
picoASMDCH020F	2 (0.079)	2.2 (0.087)	0.4 (0.016)	0.8 (0.031)	1.3 (0.051)	1.5 (0.059)	0.25 (0.010)	0.75 (0.030)	0.08 (0.003)	-
nanoASMDCH016F	3.00 (0.118)	3.40 (0.134)	0.61 (0.024)	0.89 (0.035)	1.37 (0.054)	1.80 (0.071)	0.25 (0.010)	0.75 (0.030)	0.076 (0.003)	-
nanoASMDCH035F	3.00 (0.118)	3.40 (0.134)	0.91 (0.036)	1.14 (0.045)	1.37 (0.054)	1.80 (0.071)	0.25 (0.010)	0.75 (0.030)	0.076 (0.003)	-
nanoASMDCH035F/30	3.00 (0.118)	3.40 (0.134)	1.16 (0.046)	1.46 (0.057)	1.37 (0.054)	1.80 (0.071)	0.25 (0.010)	0.75 (0.030)	0.076 (0.003)	-
nanoASMDCH050F/24	3.00 (0.118)	3.40 (0.134)	1.16 (0.046)	1.46 (0.057)	1.37 (0.054)	1.80 (0.071)	0.25 (0.010)	0.75 (0.030)	0.076 (0.003)	-
miniASMDCH050F	4.37 (0.172)	4.83 (0.190)	0.5 (0.023)	0.82 (0.032)	3.07 (0.121)	3.41 (0.134)	0.25 (0.010)	0.95 (0.040)	0.2 (0.008)	-

**Recommended Pad Layout**

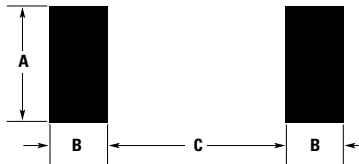

**Packaging and Marking Information**

Part Number	Tape and Reel Quantity	Standard Package	Part Marking	Recommended Pad Layout Figures [mm (in)]			Agency Recognition
				Dimension A (Nom)	Dimension B (Nom)	Dimension C (Nom)	
<b>Automotive High Temperature SMD – 16-30V</b>							
picoASMDCH005F	4000	20000	A	1.50 (0.060)	1.00 (0.039)	1.20 (0.047)	-
picoASMDCH010F	4,000	20,000	L	1.50 (0.060)	1.00 (0.039)	1.20 (0.047)	—
picoASMDCH020F	4000	20000	Y	1.50 (0.060)	1.00 (0.039)	1.20 (0.047)	-
nanoASMDCH016F	3,000	15,000	H16	1.60 (0.063)	1.00 (0.039)	2.00 (0.079)	—
nanoASMDCH035F	3,000	15,000	H35	1.60 (0.063)	1.00 (0.039)	2.00 (0.079)	—
nanoASMDCH035F/30	3,000	15,000	V	1.60 (0.063)	1.00 (0.039)	2.00 (0.079)	—
nanoASMDCH050F/24	3,000	15,000	H50	1.60 (0.063)	1.00 (0.039)	2.00 (0.079)	—
miniASMDCH050F	2000	10000	H050F	3.15 (0.124)	1.68 (0.066)	3.10 (0.122)	-

**Solder Reflow Recommendations**

Profile Feature	Pb-Free Assembly
<b>Average ramp up rate (Ts<sub>MAX</sub> to Tp)</b>	3°C/s max
<b>Preheat</b>	
• <b>Temperature min (Ts<sub>MIN</sub>)</b>	150°C
• <b>Temperature max (Ts<sub>MAX</sub>)</b>	200°C
• <b>Time (ts<sub>MIN</sub> to ts<sub>MAX</sub>)</b>	60-120 s
<b>Time maintained above:</b>	
• <b>Temperature (T<sub>L</sub>)</b>	217°C
• <b>Time (t<sub>L</sub>)</b>	60-150 s
<b>Peak/Classification temperature (Tp)</b>	260°C
<b>Time within 5°C of actual peak temperature</b>	
<b>Time (tp)</b>	30 s max
<b>Ramp down rate</b>	3°C/s max
<b>Time 25°C to peak temperature</b>	8 min max

**Note:** All temperatures refer to topside of the package, measured on the package body surface.

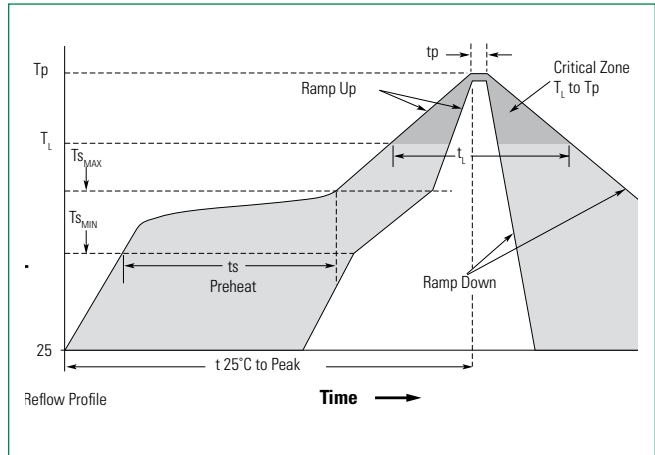

**Solder Reflow**

- Recommended reflow method: IR, hot air, nitrogen.
- Recommended maximum paste thickness: 0.25mm (0.010in)
- Devices can be cleaned using standard methods and aqueous solvents.
- Experience has shown the optimum conditions for forming acceptable solder fillets occur when a reasonable amount of solder paste is placed underneath each device's termination. As such, we request that customers comply with our recommended solder pad layouts.
- Customer should validate that the solder paste amount and reflow recommendations meet its application.
- We request that customer board layouts refrain from placing raised features (e.g. vias, nomenclature, traces, etc.) underneath PolySwitch devices. It is possible that raised features could negatively impact solderability performance of our devices.

**Rework**

- Standard industry practices. (Please also avoid direct contact to the device.)

**Part Ordering Number System**

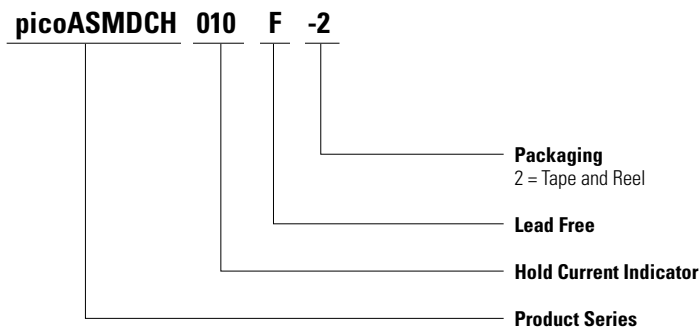

**Tape and Reel Diagrams**

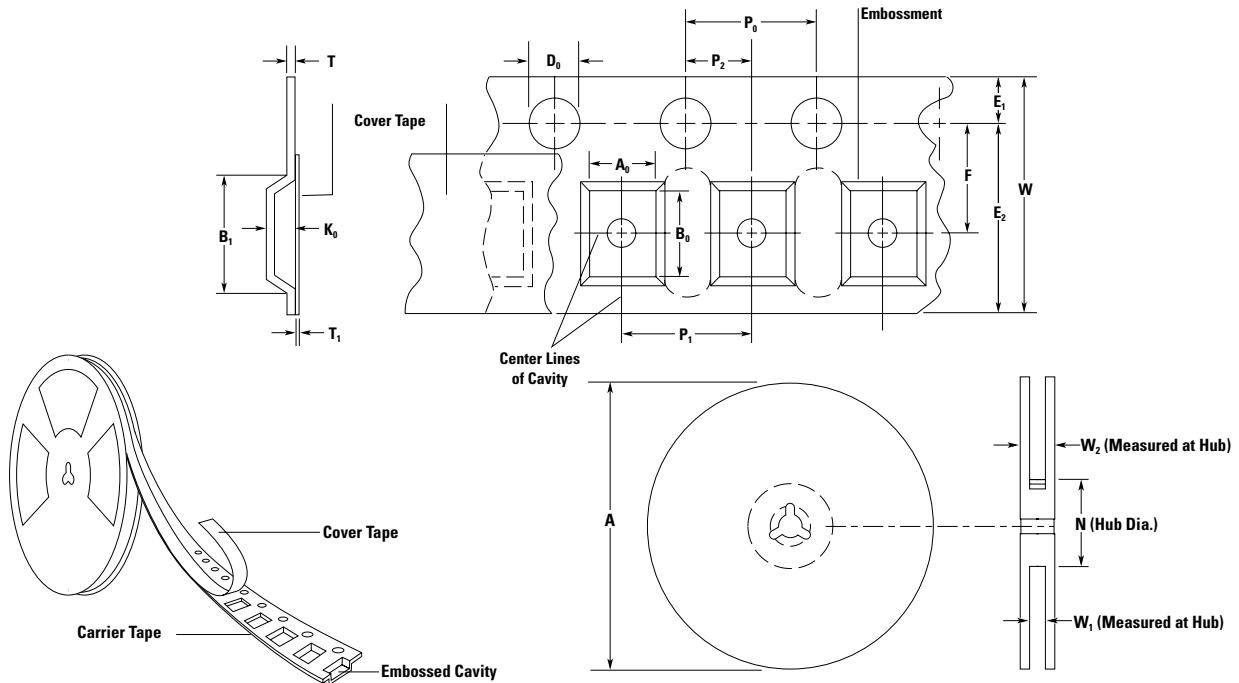

**Warning:**

- Users should independently evaluate the suitability of and test each product selected for their own application.
- Operation beyond the maximum ratings or improper use may result in device damage and possible electrical arcing and flame.
- These devices are intended for protection against damage caused by occasional overcurrent or overtemperature fault conditions and should not be used when repeated fault conditions or prolonged trip events are anticipated.
- Contamination of the PPTC material with certain silicone-based oils or some aggressive solvents can adversely impact the performance of the devices.
- Device performance can be impacted negatively if devices are handled in a manner inconsistent with recommended electronic, thermal, and mechanical procedures for electronic components.
- PPTC devices are not recommended for installation in applications where the device is constrained such that its PTC properties are inhibited, for example in rigid potting materials or in rigid housings, which lack adequate clearance to accommodate device expansion.
- Operation in circuits with a large inductance can generate a circuit voltage (Ldi/dt) above the rated voltage of the device.

**Tape and Reel Specifications**

Description	EIA 481-1			
	picoASMDCH005F picoASMDCH010F picoASMDCH020F	nanoASMDCH016F nanoASMDCH035F	nanoASMDCH035F/30 nanoASMDCH050F/24	miniASMDCH050F
<b>W</b>	8.0 ± 0.30	8.0 ± 0.30	8.0 ± 0.30	12.0 ± 0.30
<b>P<sub>0</sub></b>	4.0 ± 0.10	4.0 ± 0.10	4.0 ± 0.10	4.0 ± 0.10
<b>P<sub>1</sub></b>	4.0 ± 0.10	4.0 ± 0.10	4.0 ± 0.10	8.0 ± 0.10
<b>P<sub>2</sub></b>	2.0 ± 0.10	2.0 ± 0.05	2.0 ± 0.05	2.0 ± 0.05
<b>A<sub>0</sub></b>	1.70 ± 0.1	1.95 ± 0.1	1.95 ± 0.1	3.5 ± 0.1
<b>B<sub>0</sub></b>	2.45 ± 0.1	3.5 ± 0.1	3.5 ± 0.1	4.95 ± 0.1
<b>B<sub>1</sub> max</b>	4.35	4.35	4.35	6.15
<b>D<sub>0</sub></b>	1.55 ± .05	1.55 ± .05	1.55 ± .05	1.5 + 0.10/-.00
<b>F</b>	3.50 ± 0.05	3.50 ± 0.05	3.50 ± 0.05	5.50 ± 0.05
<b>E<sub>1</sub></b>	1.75 ± 0.10	1.75 ± 0.10	1.75 ± 0.10	1.75 ± 0.10
<b>E<sub>2</sub> min</b>	6.25	6.25	6.25	10.25
<b>T max</b>	0.3	0.6	0.6	0.35
<b>T<sub>1</sub> max</b>	0.1	0.1	0.1	0.1
<b>K<sub>0</sub></b>	0.86 ± 0.1	1.27 ± 0.1	1.50 ± 0.1	0.9 ± 0.1
<b>A max</b>	185	185	185	185
<b>N min</b>	50	50	50	50
<b>W<sub>1</sub></b>	8.4 + 1.5/-0.00	8.4 + 1.5/-0.00	8.4 + 1.5/-0.00	12.4 + 2.0/-0.00
<b>W<sub>2</sub> max</b>	14.4	14.4	14.4	18.4

**Disclaimer Notice** - Information furnished is believed to be accurate and reliable. However, users should independently evaluate the suitability of and test each product selected for their own applications. Littelfuse products are not designed for, and may not be used in, all applications. Read complete Disclaimer Notice at [www.littelfuse.com/disclaimer-electronics](http://www.littelfuse.com/disclaimer-electronics).