

DK208D Rectifier Diode

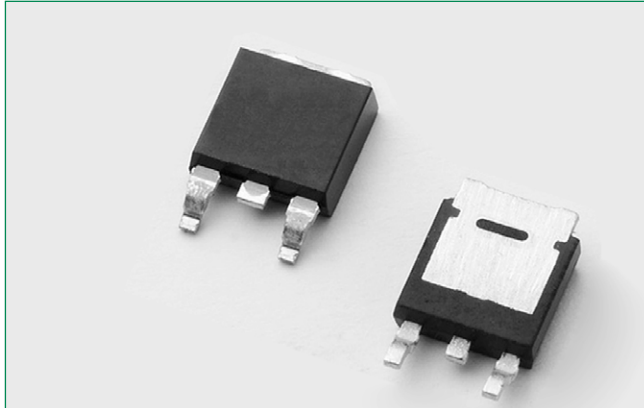

Description

This DK208D 8A, 1200V rated standard recovery rectifier diode in a compact TO-252 surface mount package is ideal as a bypass diode or anti-parallel diode for active switching component.

Features & Benefits

- Standard recovery rectifier
- Voltage capability up to 1200V
- 50Hz surge capability up to 150A
- High di/dt capability
- Halogen free and RoHS compliant

Schematic Symbol

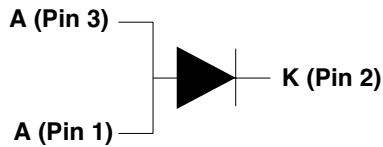

Main Features

Symbol	Value	Unit
$I_{F(AV)}$	8	A
V_{RRM}	1200	V

Applications

Typical applications are high voltage pulse generator using capacitor discharge such as electric fences and stun guns, and high voltage DC to DC converter seen in small EV / E-bike charger systems.

Absolute Maximum Ratings

Symbol	Parameter	Test Conditions	Value	Unit
$I_{F(RMS)}$	RMS forward current	$T_c = 130^\circ\text{C}$	12.6	A
$I_{F(AV)}$	Average forward current		8.0	A
I_{FSM}	Peak non-repetitive surge current	single half cycle; $f = 50\text{Hz}$; $T_j(\text{initial}) = 25^\circ\text{C}$	150	A
		single half cycle; $f = 60\text{Hz}$; $T_j(\text{initial}) = 25^\circ\text{C}$	180	
I^2t	I^2t Value for fusing	$t_p = 8.3\text{ ms}$	134	A^2s
di/dt	Critical rate of rise of on-state current	$f = 50\text{Hz}$; $T_j = 50^\circ\text{C}$	350	$\text{A}/\mu\text{s}$
T_{stg}	Storage temperature range		-40 to 150	$^\circ\text{C}$
T_j	Operating junction temperature range		-40 to 150	$^\circ\text{C}$

Electrical Characteristics ($T_J = 25^\circ\text{C}$, unless otherwise specified)

Symbol	Parameter	Test Conditions		Value	Unit
t_{rr}	Reverse-recovery Time	$I_F=0.9A, I_R=1.5A$	TYP.	4	μs

Static Characteristics

Symbol	Test Conditions			Value	Unit
V_{FM}	$I_T = 8A; t_p = 380\mu\text{s}$		MAX.	1.2	V
I_{RM}	V_{RRM}	$T_J = 25^\circ\text{C}$	MAX.	20	μA
		$T_J = 125^\circ\text{C}$		500	
		$T_J = 150^\circ\text{C}$		1000	

Thermal Resistances

Symbol	Parameter	Value	Unit
$R_{\theta(JC)}$	Junction to case (AC)	1.4	$^\circ\text{C/W}$

Figure 1: On-State Current vs. On-State Voltage (Typical)

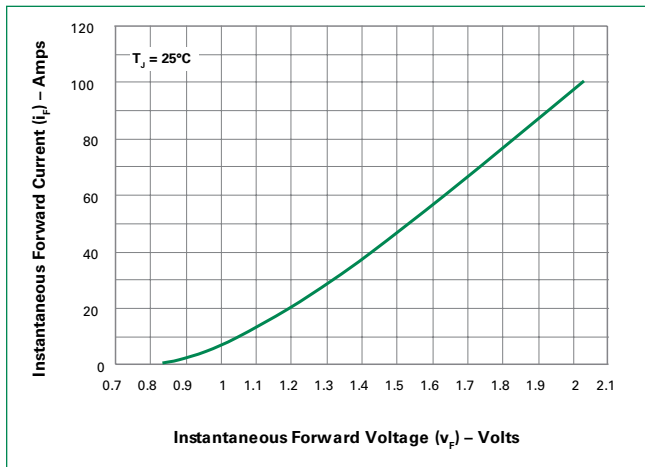

Figure 2: Power Dissipation vs. Average Forward On-State Current (Typical)

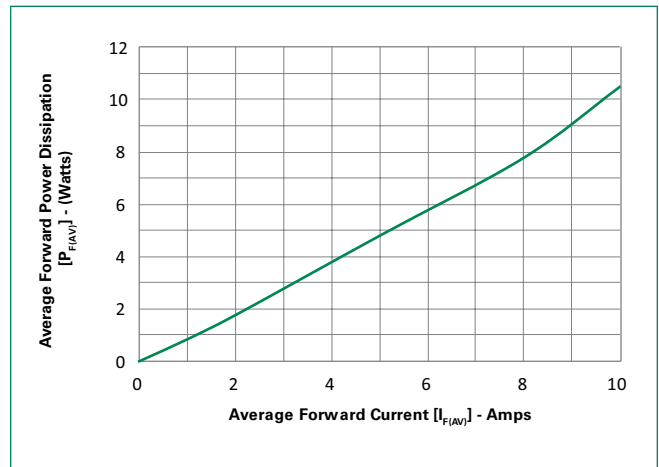
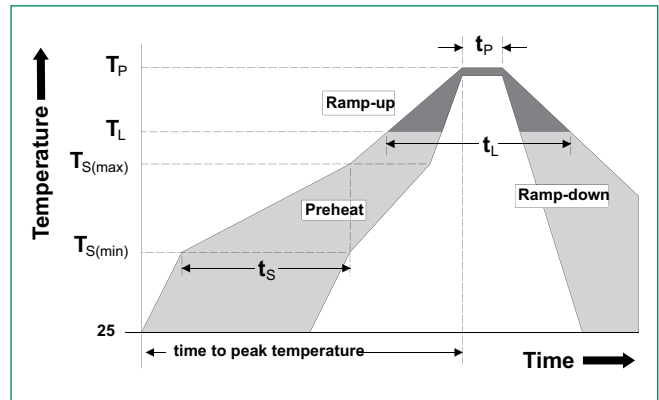

Figure 3: Maximum Allowable Case Temperature vs. Average On-State Current



Soldering Parameters

Reflow Condition		Pb – Free assembly
Pre Heat	- Temperature Min ($T_{s(min)}$)	150°C
	- Temperature Max ($T_{s(max)}$)	200°C
	- Time (min to max) (t_i)	60 – 180 secs
Average ramp up rate (Liquidus Temp) (T_L) to peak		5°C/second max
$T_{s(max)}$ to T_L - Ramp-up Rate		5°C/second max
Reflow	- Temperature (T_L) (Liquidus)	217°C
	- Time (t_L)	60 – 150 seconds
Peak Temperature (T_p)		260 ^{+0/-5} °C
Time within 5°C of actual peak Temperature (t_p)		20 – 40 seconds
Ramp-down Rate		5°C/second max
Time 25°C to peak Temperature (T_p)		8 minutes Max.
Do not exceed		280°C



Physical Specifications

Terminal Finish	100% Matte Tin Plated
Body Material	UL Recognized compound meeting flammability rating V-0.
Lead Material	Copper Alloy

Design Considerations

Careful selection of the correct component for the application's operating parameters and environment will go a long way toward extending the operating life of the rectifier. Good design practice should limit the maximum continuous current through the main terminals to 75% of the component rating. Other ways to ensure long life for a power discrete semiconductor are proper heat sinking and selection of voltage ratings for worst case conditions. Overheating, overvoltage (including dv/dt), and surge currents are the main killers of semiconductors. Correct mounting, soldering, and forming of the leads also help protect against component damage.

Environmental Specifications

Test	Specifications and Conditions
High Temperature Voltage Blocking	MIL-STD-750: Method 1040, Condition A Rated V_{RRM} : 150°C, 168 hours
Temperature Cycling	MIL-STD-750: Method 1051 -40°C to 125°C, 15-minute dwell, 100 cycles
Biased Temperature & Humidity	EIA/JEDEC: JESD22-A101 320VDC, 85°C, 85%RH, 168 hours
High Temp Storage	MIL-STD-750: Method 1031 150°C, 1008 hours
Low-Temp Storage	1008 hours; -40°C
Resistance to Solder Heat	MIL-STD-750: Method 2031 260°C, 10 seconds
Solderability	ANSI/J-STD-002, Category 3, Test A
Lead Bend	MIL-STD-750: Method 2036, Condition E
Moisture Sensitivity Level	Level 1, JEDEC-J-STD-020

Dimensions — TO-252AA (D-Package) — D-PAK Surface Mount

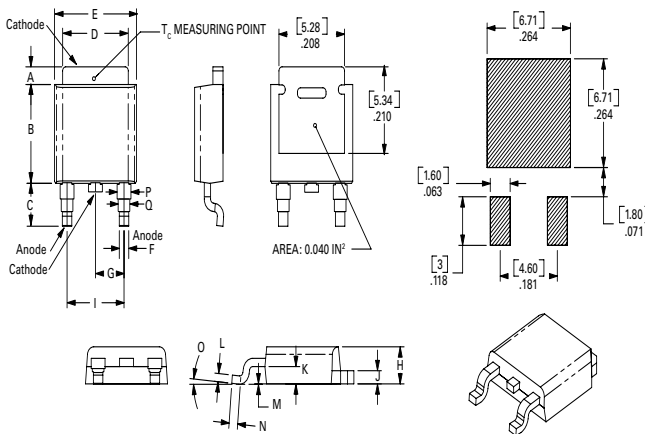

Dimension	Inches			Millimeters		
	Min	Typ	Max	Min	Typ	Max
A	0.037	0.040	0.043	0.94	1.01	1.09
B	0.235	0.243	0.245	5.97	6.16	6.22
C	0.106	0.108	0.113	2.69	2.74	2.87
D	0.205	0.208	0.213	5.21	5.29	5.41
E	0.255	0.262	0.265	6.48	6.65	6.73
F	0.027	0.031	0.033	0.69	0.80	0.84
G	0.087	0.090	0.093	2.21	2.28	2.36
H	0.085	0.092	0.095	2.16	2.33	2.41
I	0.176	0.179	0.184	4.47	4.55	4.67
J	0.018	0.020	0.023	0.46	0.51	0.58
K	0.035	0.037	0.039	0.90	0.95	1.00
L	0.018	0.020	0.023	0.46	0.51	0.58
M	0.000	0.000	0.004	0.00	0.00	0.10
N	0.021	0.026	0.027	0.53	0.67	0.69
O	0°	0°	5°	0°	0°	5°
P	0.042	0.047	0.052	1.06	1.20	1.32
Q	0.034	0.039	0.044	0.86	1.00	1.11

Packing Option

Part Number	Marking	Weight	Packing Mode	Base Quantity
DK208DRP	DK208D	0.3 g	Embossed Carrier	2500

Part Numbering System

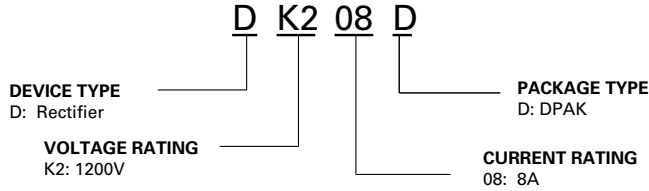

Part Marking System

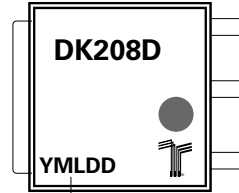

Date Code Marking
Y: Year Code
M: Month Code
L: Location Code
DD: Calendar Code

TO-252 Embossed Carrier Reel Pack (RP) Specifications

Meets all EIA-481-2 Standards

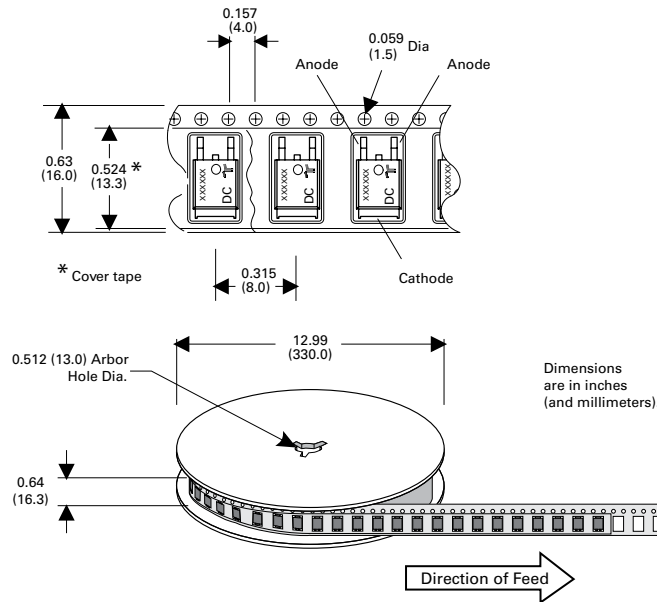

Disclaimer Notice - Information furnished is believed to be accurate and reliable. However, users should independently evaluate the suitability of and test each product selected for their own applications. Littelfuse products are not designed for, and may not be used in, all applications. Read complete Disclaimer Notice at <http://www.littelfuse.com/disclaimer-electronics>.