

SMCJ Series



Agency Approvals

| Agency | Agency File Number |
|--------|--------------------|
| | E230531 |

Maximum Ratings and Thermal Characteristics ($T_A=25^\circ\text{C}$ unless otherwise noted)

| Parameter | Symbol | Value | Unit |
|--|-----------------|------------|--------------------|
| Peak Pulse Power Dissipation at $T_A=25^\circ\text{C}$ by 10/1000 μs Waveform (Fig.2)(Note 1), (Note 2), (Note 5) | P_{PPM} | 1500 | W |
| Power Dissipation on Infinite Heat Sink at $T_L=50^\circ\text{C}$ | P_D | 6.5 | W |
| Peak Forward Surge Current, 8.3ms Single Half Sine Wave (Note 3) | I_{FSM} | 200 | A |
| Maximum Instantaneous Forward Voltage at 100A for Unidirectional Only (Note 4) | V_F | 3.5/5.0 | V |
| Operating Temperature Range | T_J | -65 to 150 | $^\circ\text{C}$ |
| Storage Temperature Range | T_{STG} | -65 to 175 | $^\circ\text{C}$ |
| Typical Thermal Resistance Junction to Lead | $R_{\theta JL}$ | 15 | $^\circ\text{C/W}$ |
| Typical Thermal Resistance Junction to Ambient | $R_{\theta JA}$ | 75 | $^\circ\text{C/W}$ |

Notes:

1. Non-repetitive current pulse, per Fig. 4 and derated above T_J (initial) $=25^\circ\text{C}$ per Fig. 3.
2. Mounted on copper pad area of 0.31x0.31" (8.0 x 8.0mm) to each terminal.
3. Measured on 8.3ms single half sine wave or equivalent square wave for unidirectional device only, duty cycle=4 per minute maximum.
4. $V_F < 3.5\text{V}$ for single die parts and $V_F < 5.0\text{V}$ for stacked-die parts.
5. The P_{PPM} of stacked-die parts is 2000W and please contact littelfuse for the detail stacked-die parts.

Description

The SMCJ series is designed specifically to protect sensitive electronic equipment from voltage transients induced by lightning and other transient voltage events.

Features

- 1500W peak pulse power capability at 10/1000 μs waveform, repetition rate (duty cycles):0.01%
- Excellent clamping capability
- Low incremental surge resistance
- Typical I_R less than 1 μA when $V_{BR\ min} > 12\text{V}$
- For surface mounted applications to optimize board space
- Low profile package
- Built-in strain relief
- Typical failure mode is short from over-specified voltage or current
- Whisker test is conducted based on JEDEC JESD201A per its table 4a and 4c
- IEC 61000-4-2 ESD 30kV(Air), 30kV (Contact)
- ESD protection of data lines in accordance with IEC 61000-4-2
- EFT protection of data lines in accordance with IEC 61000-4-4
- Fast response time: typically less than 1.0ps from 0V to BV min
- Glass passivated chip junction
- High temperature to reflow soldering guaranteed: 260 $^\circ\text{C}/40\text{sec}$
- $V_{BR} @ T_J = V_{BR} @ 25^\circ\text{C} \times (1 + \alpha T \times (T_J - 25))$ (αT : Temperature Coefficient, typical value is 0.1%)
- Plastic package is flammability rated V-0 per Underwriters Laboratories
- Meet MSL level1, per J-STD-020, LF maximum peak of 260 $^\circ\text{C}$
- Matte tin lead-free plated
- Halogen free and RoHS compliant
- Pb-free E3 means 2nd level interconnect is Pb-free and the terminal finish material is tin(Sn) (IPC/ JEDEC J-STD-609A.01)

Applications

TVS devices are ideal for the protection of I/O Interfaces, V_{CC} bus and other vulnerable circuits used in Telecom, Computer, Industrial and Consumer electronic applications.

Functional Diagram

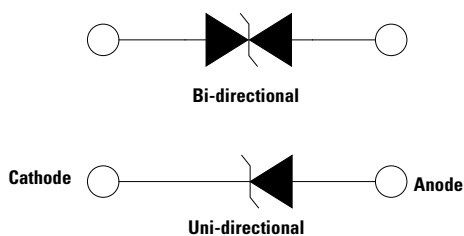

Additional Information



Datasheet



Resources



Samples

Electrical Characteristics (T_A=25°C unless otherwise noted)

| Part Number (Uni) | Part Number (Bi) | Marking | | Reverse Stand off Voltage V _R (Volts) | Breakdown Voltage V _{BR} (Volts) @ I _T | | Test Current I _T (mA) | Maximum Clamping Voltage V _C @ I _{pp} (V) | Maximum Peak Pulse Current I _{pp} (A) | Maximum Reverse Leakage I _R @ V _R (μA) | Agency Approval  |
|-------------------|------------------|---------|-----|--|--|--------|----------------------------------|---|--|--|---|
| | | UNI | BI | | MIN | MAX | | | | | |
| SMCJ5.0A | SMCJ5.0CA | GDE | BDE | 5.0 | 6.40 | 7.00 | 10 | 9.2 | 163.0 | 800 | X |
| SMCJ6.0A | SMCJ6.0CA | GDG | BDG | 6.0 | 6.67 | 7.37 | 10 | 10.3 | 145.7 | 800 | X |
| SMCJ6.5A | SMCJ6.5CA | GDK | BDK | 6.5 | 7.22 | 7.98 | 10 | 11.2 | 134.0 | 500 | X |
| SMCJ7.0A | SMCJ7.0CA | GDM | BDM | 7.0 | 7.78 | 8.60 | 10 | 12.0 | 125.0 | 200 | X |
| SMCJ7.5A | SMCJ7.5CA | GDP | BDP | 7.5 | 8.33 | 9.21 | 1 | 12.9 | 116.3 | 100 | X |
| SMCJ8.0A | SMCJ8.0CA | GDR | BDR | 8.0 | 8.89 | 9.83 | 1 | 13.6 | 110.3 | 50 | X |
| SMCJ8.5A | SMCJ8.5CA | GDT | BDT | 8.5 | 9.44 | 10.40 | 1 | 14.4 | 104.2 | 20 | X |
| SMCJ9.0A | SMCJ9.0CA | GDV | BDV | 9.0 | 10.00 | 11.10 | 1 | 15.4 | 97.4 | 10 | X |
| SMCJ10A | SMCJ10CA | GDX | BDX | 10.0 | 11.10 | 12.30 | 1 | 17.0 | 88.3 | 5 | X |
| SMCJ11A | SMCJ11CA | GDZ | BDZ | 11.0 | 12.20 | 13.50 | 1 | 18.2 | 82.5 | 1 | X |
| SMCJ12A | SMCJ12CA | GEE | BEE | 12.0 | 13.30 | 14.70 | 1 | 19.9 | 75.4 | 1 | X |
| SMCJ13A | SMCJ13CA | GEG | BEG | 13.0 | 14.40 | 15.90 | 1 | 21.5 | 69.8 | 1 | X |
| SMCJ14A | SMCJ14CA | GEK | BEK | 14.0 | 15.60 | 17.20 | 1 | 23.2 | 64.7 | 1 | X |
| SMCJ15A | SMCJ15CA | GEM | BEM | 15.0 | 16.70 | 18.50 | 1 | 24.4 | 61.5 | 1 | X |
| SMCJ16A | SMCJ16CA | GEP | BEP | 16.0 | 17.80 | 19.70 | 1 | 26.0 | 57.7 | 1 | X |
| SMCJ17A | SMCJ17CA | GER | BER | 17.0 | 18.90 | 20.90 | 1 | 27.6 | 54.4 | 1 | X |
| SMCJ18A | SMCJ18CA | GET | BET | 18.0 | 20.00 | 22.10 | 1 | 29.2 | 51.4 | 1 | X |
| SMCJ20A | SMCJ20CA | GEV | BEV | 20.0 | 22.20 | 24.50 | 1 | 32.4 | 46.3 | 1 | X |
| SMCJ22A | SMCJ22CA | GEX | BEX | 22.0 | 24.40 | 26.90 | 1 | 35.5 | 42.3 | 1 | X |
| SMCJ24A | SMCJ24CA | GEZ | BEZ | 24.0 | 26.70 | 29.50 | 1 | 38.9 | 38.6 | 1 | X |
| SMCJ26A | SMCJ26CA | GFE | BFE | 26.0 | 28.90 | 31.90 | 1 | 42.1 | 35.7 | 1 | X |
| SMCJ28A | SMCJ28CA | GFG | BFG | 28.0 | 31.10 | 34.40 | 1 | 45.4 | 33.1 | 1 | X |
| SMCJ30A | SMCJ30CA | GFK | BFK | 30.0 | 33.30 | 36.80 | 1 | 48.4 | 31.0 | 1 | X |
| SMCJ33A | SMCJ33CA | GFM | BFM | 33.0 | 36.70 | 40.60 | 1 | 53.3 | 28.2 | 1 | X |
| SMCJ36A | SMCJ36CA | GFP | BFP | 36.0 | 40.00 | 44.20 | 1 | 58.1 | 25.9 | 1 | X |
| SMCJ40A | SMCJ40CA | GFR | BFR | 40.0 | 44.40 | 49.10 | 1 | 64.5 | 23.3 | 1 | X |
| SMCJ43A | SMCJ43CA | GFT | BFT | 43.0 | 47.80 | 52.80 | 1 | 69.4 | 21.7 | 1 | X |
| SMCJ45A | SMCJ45CA | GFV | BFV | 45.0 | 50.00 | 55.30 | 1 | 72.7 | 20.6 | 1 | X |
| SMCJ48A | SMCJ48CA | GFX | BFX | 48.0 | 53.30 | 58.90 | 1 | 77.4 | 19.4 | 1 | X |
| SMCJ51A | SMCJ51CA | GFZ | BFZ | 51.0 | 56.70 | 62.70 | 1 | 82.4 | 18.2 | 1 | X |
| SMCJ54A | SMCJ54CA | GGE | BGE | 54.0 | 60.00 | 66.30 | 1 | 87.1 | 17.3 | 1 | X |
| SMCJ58A | SMCJ58CA | GGG | BGG | 58.0 | 64.40 | 71.20 | 1 | 93.6 | 16.1 | 1 | X |
| SMCJ60A | SMCJ60CA | GGK | BGK | 60.0 | 66.70 | 73.70 | 1 | 96.8 | 15.5 | 1 | X |
| SMCJ64A | SMCJ64CA | GGM | BGM | 64.0 | 71.10 | 78.60 | 1 | 103.0 | 14.6 | 1 | X |
| SMCJ70A | SMCJ70CA | GGP | BGP | 70.0 | 77.80 | 86.00 | 1 | 113.0 | 13.3 | 1 | X |
| SMCJ75A | SMCJ75CA | GGR | BGR | 75.0 | 83.30 | 92.10 | 1 | 121.0 | 12.4 | 1 | X |
| SMCJ78A | SMCJ78CA | GGT | BGT | 78.0 | 86.70 | 95.80 | 1 | 126.0 | 11.9 | 1 | X |
| SMCJ85A | SMCJ85CA | GGV | BGV | 85.0 | 94.40 | 104.00 | 1 | 137.0 | 11.0 | 1 | X |
| SMCJ90A | SMCJ90CA | GGX | BGX | 90.0 | 100.00 | 111.00 | 1 | 146.0 | 10.3 | 1 | X |
| SMCJ100A | SMCJ100CA | GGZ | BGZ | 100.0 | 111.00 | 123.00 | 1 | 162.0 | 9.3 | 1 | X |
| SMCJ110A | SMCJ110CA | GHE | BHE | 110.0 | 122.00 | 135.00 | 1 | 177.0 | 8.5 | 1 | X |
| SMCJ120A | SMCJ120CA | GHG | BHG | 120.0 | 133.00 | 147.00 | 1 | 193.0 | 7.8 | 1 | X |
| SMCJ130A | SMCJ130CA | GHK | BHK | 130.0 | 144.00 | 159.00 | 1 | 209.0 | 7.2 | 1 | X |
| SMCJ150A | SMCJ150CA | GHM | BHM | 150.0 | 167.00 | 185.00 | 1 | 243.0 | 6.2 | 1 | X |
| SMCJ160A | SMCJ160CA | GHP | BHP | 160.0 | 178.00 | 197.00 | 1 | 259.0 | 5.8 | 1 | X |
| SMCJ170A | SMCJ170CA | GHR | BHR | 170.0 | 189.00 | 209.00 | 1 | 275.0 | 5.5 | 1 | X |
| SMCJ180A | SMCJ180CA | GHT | BHT | 180.0 | 201.00 | 222.00 | 1 | 292.0 | 5.1 | 1 | X |
| SMCJ200A | SMCJ200CA | GHV | BHV | 200.0 | 224.00 | 247.00 | 1 | 324.0 | 4.6 | 1 | X |
| SMCJ220A | SMCJ220CA | GHX | BHX | 220.0 | 246.00 | 272.00 | 1 | 356.0 | 4.2 | 1 | X |
| SMCJ250A | SMCJ250CA | GHZ | BHZ | 250.0 | 279.00 | 309.00 | 1 | 405.0 | 3.7 | 1 | X |
| SMCJ300A | SMCJ300CA | GJE | BJE | 300.0 | 335.00 | 371.00 | 1 | 486.0 | 3.1 | 1 | X |
| SMCJ350A | SMCJ350CA | GJG | BJG | 350.0 | 391.00 | 432.00 | 1 | 567.0 | 2.6 | 1 | X |
| SMCJ400A | SMCJ400CA | GJK | BJK | 400.0 | 447.00 | 494.00 | 1 | 648.0 | 2.3 | 1 | X |
| SMCJ440A | SMCJ440CA | GJM | BJM | 440.0 | 492.00 | 543.00 | 1 | 713.0 | 2.1 | 1 | X |

For bidirectional type having V_o of 10 volts and less, the I_o limit is double.

For parts without A, the V_{BR} is ± 10% and V_C is 5% higher than with A parts, the parts without A are currently available, but not recommended for new designs. The parts with A are preferred.

I-V Curve Characteristics

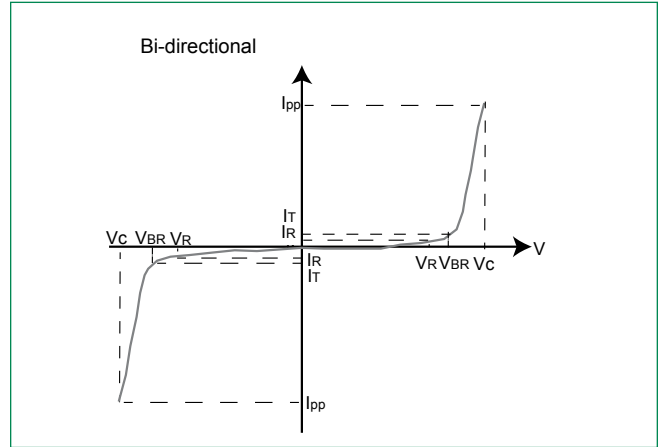
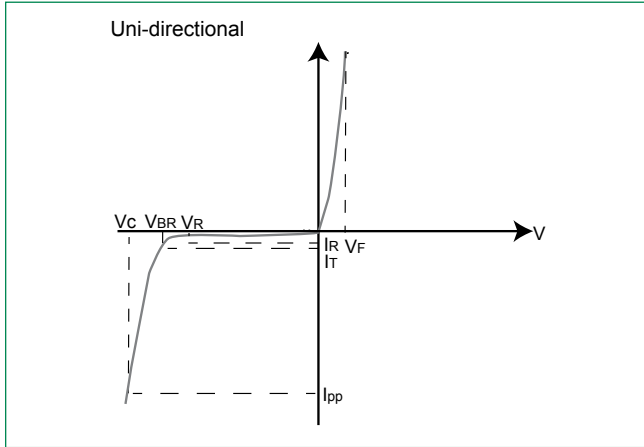

- P_{PPM} Peak Pulse Power Dissipation** – Max power dissipation
- V_R Stand-off Voltage** – Maximum voltage that can be applied to the TVS without operation
- V_{BR} Breakdown Voltage** – Maximum voltage that flows through the TVS at a specified test current (I_T)
- V_C Clamping Voltage** – Peak voltage measured across the TVS at a specified I_{ppm} (peak impulse current)
- I_R Reverse Leakage Current** – Current measured at V_R
- V_F Forward Voltage Drop for Uni-directional**

Ratings and Characteristic Curves ($T_A=25^\circ\text{C}$ unless otherwise noted)

Figure 1 - TVS Transients Clamping Waveform

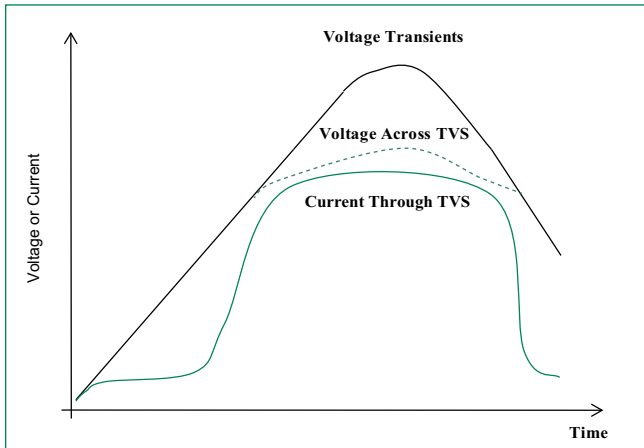
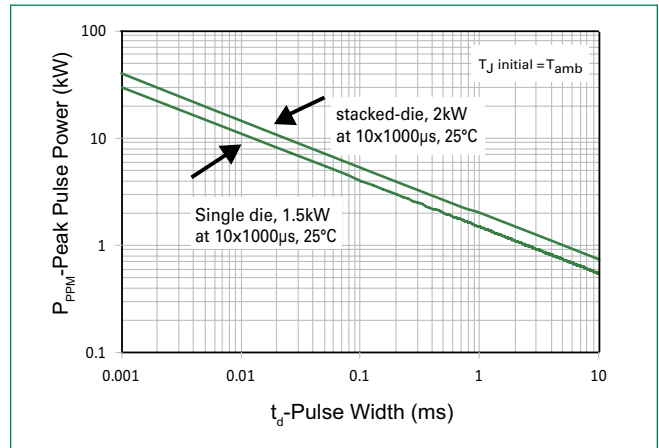

Figure 2 - Peak Pulse Power Rating



Ratings and Characteristic Curves ($T_A=25^\circ\text{C}$ unless otherwise noted) (Continued)

Figure 3 - Peak Pulse Power Derating Curve

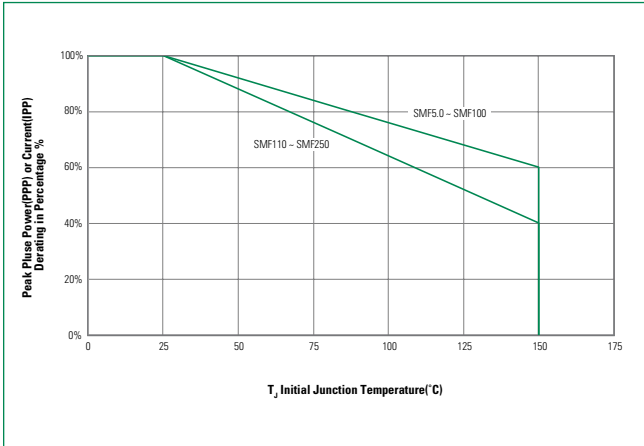

Figure 4 - Pulse Waveform

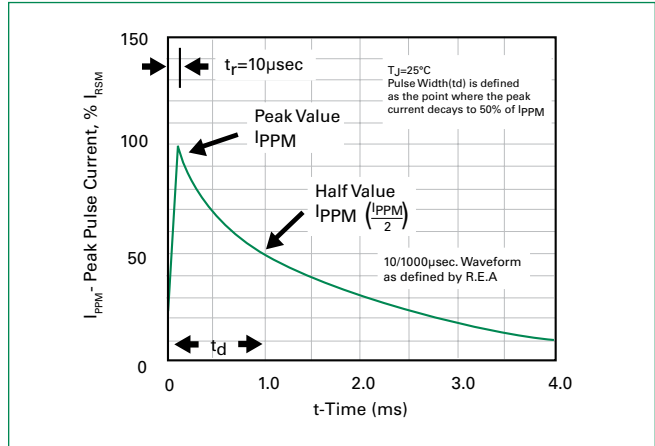

Figure 5 - Typical Junction Capacitance

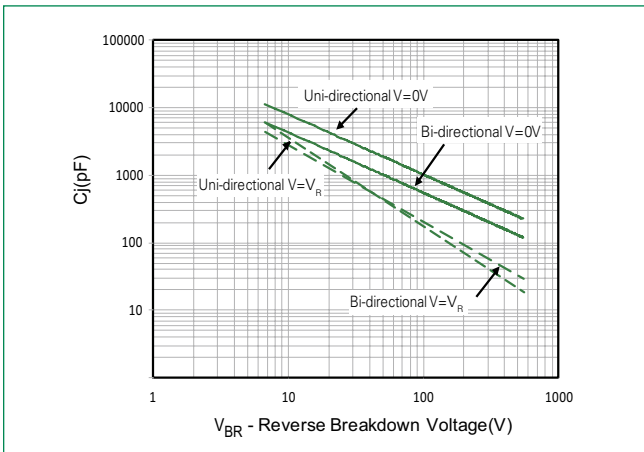

Figure 6 - Typical Transient Thermal Impedance

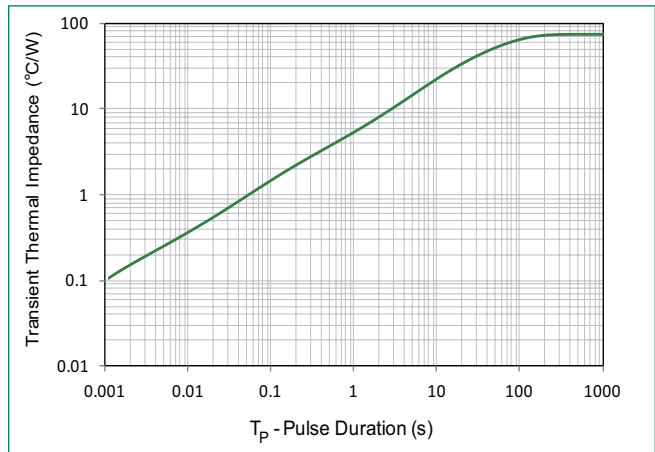

Figure 7 - Maximum Non-Repetitive Peak Forward Surge Current Uni-Directional Only

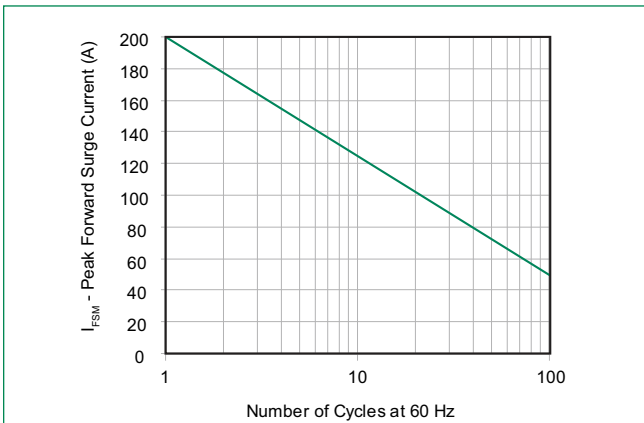
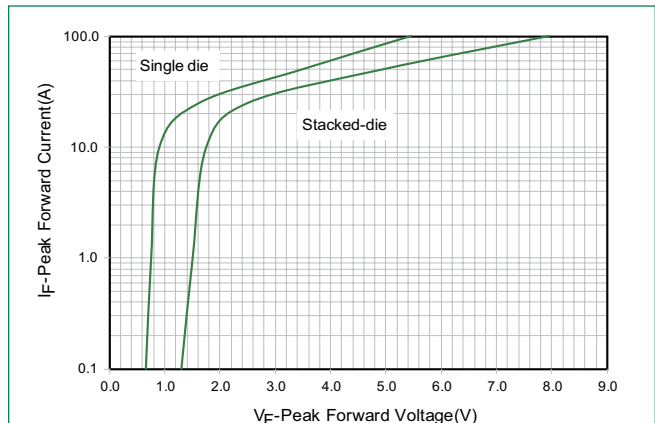
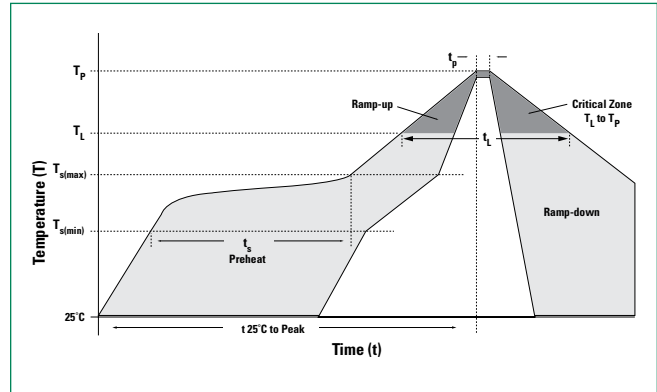

Figure 8 - Peak Forward Voltage Drop vs Peak Forward Current (Typical Values)



Soldering Parameters

| | | |
|--|------------------------------------|-------------------------|
| Reflow Condition | | Lead-free assembly |
| Pre Heat | - Temperature Min ($T_{s(min)}$) | 150°C |
| | - Temperature Max ($T_{s(max)}$) | 200°C |
| | - Time (min to max) (t_s) | 60 – 180 secs |
| Average ramp up rate (Liquidus Temp (T_A) to peak) | | 3°C/second max |
| $T_{s(max)}$ to T_A - Ramp-up Rate | | 3°C/second max |
| Reflow | - Temperature (T_A) (Liquidus) | 217°C |
| | - Time (min to max) (t_s) | 60 – 150 seconds |
| Peak Temperature (T_p) | | 260 ^{+0/-5} °C |
| Time within 5°C of actual peak Temperature (t_p) | | 20 – 40 seconds |
| Ramp-down Rate | | 6°C/second max |
| Time 25°C to peak Temperature (T_p) | | 8 minutes Max. |
| Do not exceed | | 260°C |



Physical Specifications

| | |
|-----------------|---|
| Weight | 0.007 ounce, 0.21 grams |
| Case | JEDEC DO214AB. Molded plastic body over glass passivated junction |
| Polarity | Color band denotes positive end (cathode) except Bidirectional. |
| Terminal | Matte Tin-plated leads, Solderable per JESD22-B102 |

Environmental Specifications

| | |
|----------------------------|--------------------------|
| High Temp. Storage | JESD22-A103 |
| HTRB | JESD22-A108 |
| Temperature Cycling | JESD22-A104 |
| MSL | JEDEC-J-STD-020, Level 1 |
| H3TRB | JESD22-A101 |
| RSH | JESD22-A111 |

Dimensions

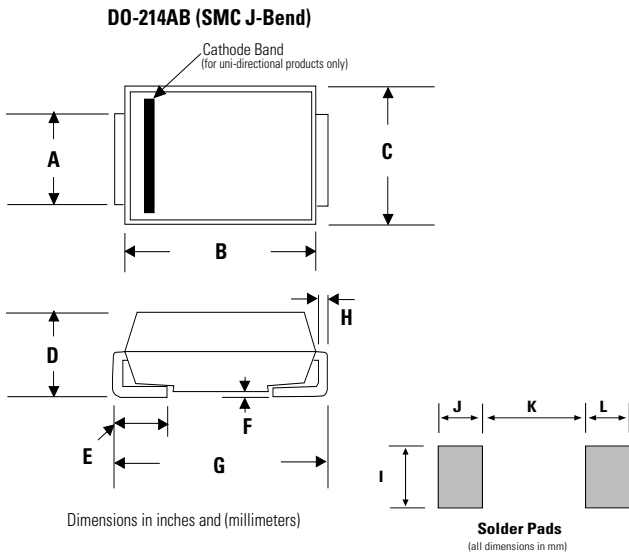

| Dimensions | Inches | | Millimeters | |
|------------|--------|-------|-------------|-------|
| | Min | Max | Min | Max |
| A | 0.114 | 0.126 | 2.900 | 3.200 |
| B | 0.260 | 0.280 | 6.600 | 7.110 |
| C | 0.220 | 0.245 | 5.590 | 6.220 |
| D | 0.079 | 0.103 | 2.060 | 2.620 |
| E | 0.030 | 0.060 | 0.760 | 1.520 |
| F | - | 0.008 | - | 0.203 |
| G | 0.305 | 0.320 | 7.750 | 8.130 |
| H | 0.006 | 0.012 | 0.152 | 0.305 |
| I | 0.129 | - | 3.300 | - |
| J | 0.094 | - | 2.400 | - |
| K | - | 0.165 | - | 4.200 |
| L | 0.094 | - | 2.400 | - |

Part Numbering System

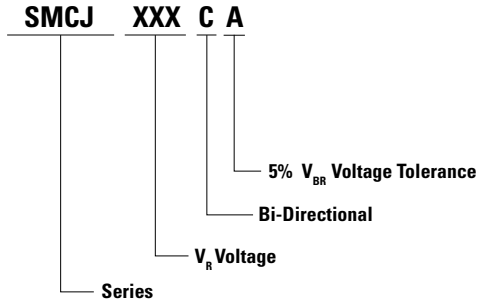

Part Marking System

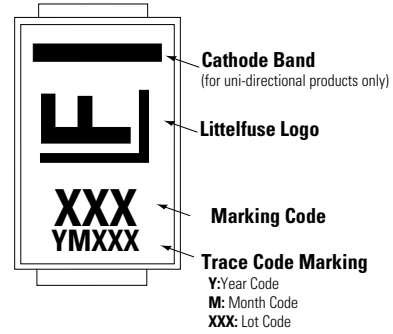

Packaging

| Part number | Component Package | Quantity | Packaging Option | Packaging Specification |
|-------------|-------------------|----------|----------------------------------|-------------------------|
| SMCJxxxXX | DO-214AB | 3000 | Tape & Reel - 16mm tape/13" reel | EIA STD RS-481 |

Tape and Reel Specification

