

## 0201 MLA Varistor Series

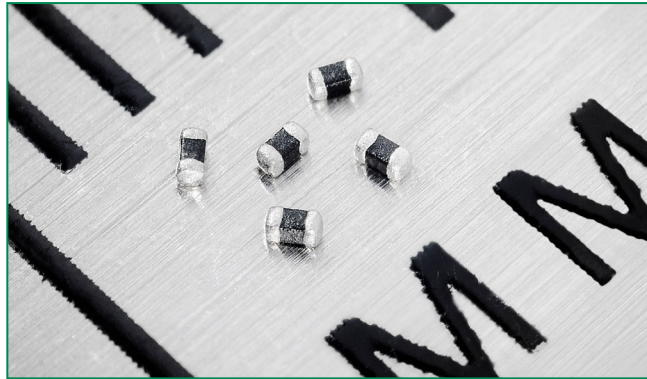

### Absolute Maximum Ratings

Steady State Applied Voltage:		Unit
Maximum DC Voltage ( $V_{M(DC)}$ )	5.5	V
Maximum AC Voltage ( $V_{M(AC)(RMS)}$ )	4.0	V
Transient:		
Non-Repetitive Surge Current, 8/20 $\mu$ s Waveform, ( $I_{TM}$ )	4.0	A
Temperature:		
Operating Ambient Temperature Range ( $T_A$ )	-40 to +85	°C
Storage Temperature Range ( $T_{STG}$ )	-40 to +85	°C

### Description

New 0201-size MLA Multi-Layer Varistor (MLV) series can protect small electronic products from electrostatic discharge (ESD) and electrically fast transients (EFT).

It's ultra-compact 0201 size, the smallest form factor available for MLV devices, is ideal for compact handheld products.

The MLA Series is manufactured from semiconducting ceramics, and is supplied in a leadless, surface mount package.

Plating consists of Silver base material (which is fired on to the Zn dielectric), Nickel barrier plated under-layer and Matte-Tin outer surface plate.

### Features

- Ultra-small 0201 size for minimal board space
- Low capacitance (33pF) for high data rates to minimize signal distortion
- Meets IEC 61000-4-2 for ESD
- Low leakage (<25 $\mu$ A)
- Multilayer ceramic construction technology
- Inherently Bi-directional
- Stable performance over wide operating and storage temperature range -40°C to +85°C
- Operating voltage  $V_{M(DC)} = 5.5V$
- Rated for surge current (8 x 20 $\mu$ s)
- Pb-Free and RoHS Compliant

### Applications

- Portable / handheld electronic devices
- Mobile communications / cellular phones
- USB, video and audio ports
- Analog signal / sensor lines
- Data, diagnostic I/O ports
- Computer / DSP products
- Industrial instruments including non-life sustaining medical equipment

### Device Ratings and Specifications

Part Number	Maximum Ratings @ +85°C			Specifications @ +25°C			
	Maximum Continuous Working Voltage		Maximum Non-repetitive Surge Current (8/20 $\mu$ s)	Maximum Clamping Voltage at 1A (8/20 $\mu$ s)	Nominal Voltage at 1mA DC Test Current		Typical Capacitance at f = 1MHz
	$V_{M(DC)}$ (V)	$V_{M(AC)}$ (V)	$I_{TM}$ (A)	$V_C$ (V)	$V_{N(DC)}$ Min (V)	$V_{N(DC)}$ Max (V)	C (pF)
V5.5MLA020133FR	5.5	4.0	1	28.0*	8.0	14.0	33.0
V5.5MLA020133NR	5.5	4.0	1	28.0*	8.0	14.0	33.0
V5.5MLA020147NR	5.5	4.0	1	26.0*	8.0	14.0	47.0
V5.5MLA020164NR	5.5	4.0	1	26.0*	8.0	14.0	64.0

Notes:  
 - Typical leakage at 25°C at  $V_{M(DC)}$ : 0201 size <10 $\mu$ A typical, <25 $\mu$ A maximum  
 - End surface finish of Tin with Nickel barrier on Silver base material  
 - Standard packing quantity 10,000 per reel, 7" reel

### Additional Information



Datasheet



Resources



Samples

**Reliability and Environmental Specifications**

	Judge Criteria	Test Condition
Solderability	> 95% solder coverage	245 +/- °C, 3 +/- 1 sec.
Leaching Resistance	> 95% solder coverage	245 +/- °C, 3 +/- 1 sec.
High Temperature Exposure	$\Delta V_v / V_v \leq 10\%$	1000 hours 85°C, un-powered
Thermal Shock	$\Delta V_v / V_v \leq 10\%$	-45 to +85 °C, 30 min. cycle, 5 cycles
Operating Life	$\Delta V_v / V_v \leq 10\%$	85 °C, DC working voltage 1000 hours
Bias Humidity	$\Delta V_v / V_v \leq 10\%$	40 °C / 85% RH, DC working voltage 1000 hours

**Peak Pulse Current Test Waveform for Clamping Voltage**

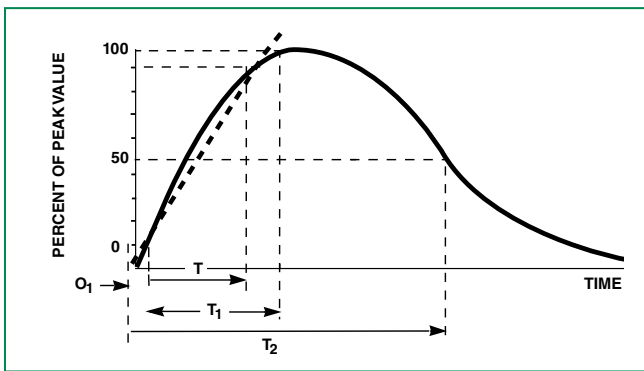

$O_1$  = Virtual Origin of Wave  
 $T$  = Time from 10% to 90% of Peak  
 $T_1$  = Rise Time = 1.25 x  $T$   
 $T_2$  = Decay Time  
**Example** - For an 8/20  $\mu$ s Current Waveform:  
 $8\mu$ s =  $T_1$  = Rise Time  
 $20\mu$ s =  $T_2$  = Decay Time

**Multilayer Internal Construction**

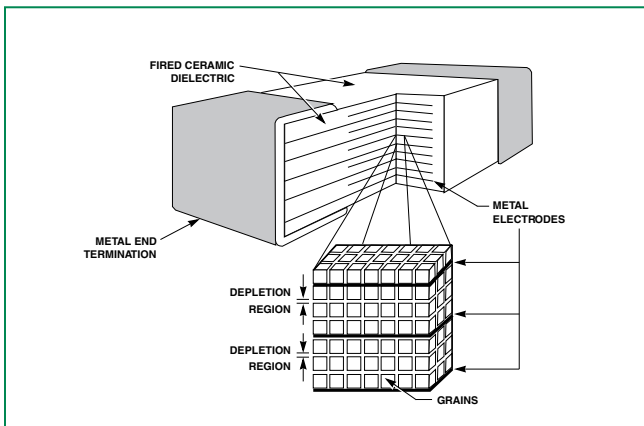

**Lead-free (Pb-free) Soldering Recommendations**

To avoid the possibility of generating stresses due to thermal shock, a preheat stage in the soldering process is recommended, and the peak temperature of the solder process should be rigidly controlled.

When using a reflow process, care should be taken to ensure that the ML chip is not subjected to a thermal gradient steeper than 4 degrees per second; the ideal gradient being 2 degrees per second. During the soldering process, preheating to within 100 degrees of the solder's peak temperature is essential to minimize thermal shock.

Once the soldering process has been completed, it is still necessary to ensure that any further thermal shocks are avoided. One possible cause of thermal shock is hot printed circuit boards being removed from the solder process and subjected to cleaning solvents at room temperature. The boards must be allowed to cool gradually to less than 50° C before cleaning.

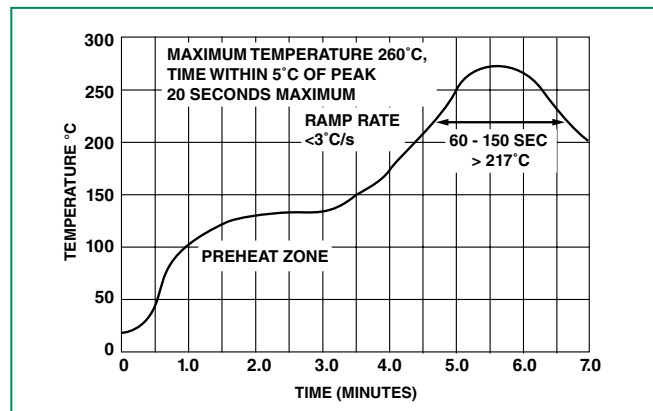

**Disclaimer Notice** - Information furnished is believed to be accurate and reliable. However, users should independently evaluate the suitability of and test each product selected for their own applications. Littelfuse products are not designed for, and may not be used in, all applications. Read complete Disclaimer Notice at [www.littelfuse.com/disclaimer-electronics](http://www.littelfuse.com/disclaimer-electronics).

### Product Dimensions (mm)

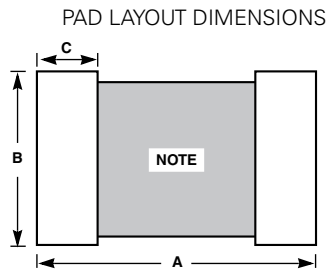

NOTE : Avoid metal runs in this area, parts not recommended for use in applications using Silver (Ag) epoxy paste.

### CHIP LAYOUT DIMENSIONS

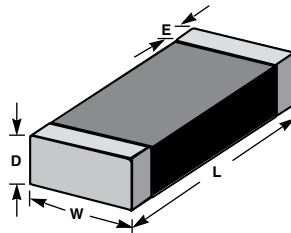

Dimension	0201 Size	
	IN	MM
<b>A</b>	0.055	1.40
<b>B</b>	0.020	0.50
<b>C</b>	0.020	0.50
<b>D (max.)</b>	0.014	0.35
<b>E</b>	0.008 $\pm$ 0.004	0.20 $\pm$ 0.10
<b>L</b>	0.024 $\pm$ 0.002	0.60 $\pm$ 0.05
<b>W</b>	0.012 $\pm$ 0.002	0.30 $\pm$ 0.05

### Part Numbering System

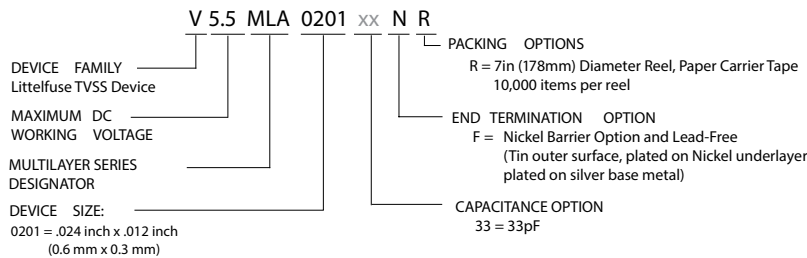

### Tape and Reel Specifications

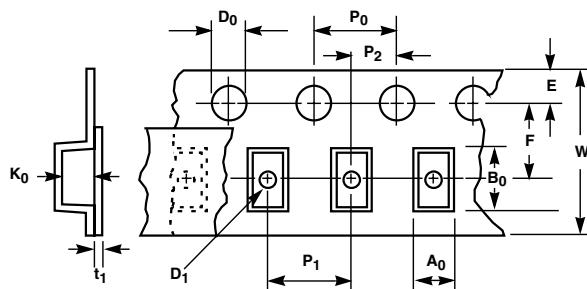

For T and H Pack Options: PLASTIC CARRIER TAPE  
 For R Pack Options: EMBOSSED PAPER CARRIER TAPE

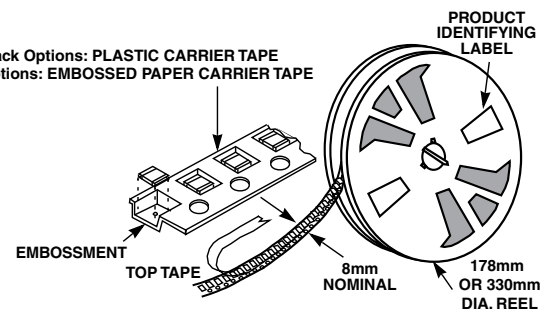

Symbol	Description	Dimensions in Millimeters
		0201
<b>A<sub>0</sub></b>	Width of Cavity	0.36 $\pm$ 0.02
<b>B<sub>0</sub></b>	Length of Cavity	0.70 $\pm$ 0.02
<b>W</b>	Width of Tape	8.0 $\pm$ 0.1
<b>F</b>	Distance Between Drive Hole Centers and Cavity Centers	3.5 $\pm$ 0.05
<b>E</b>	Distance Between Drive Hole Centers and Tape Edge	1.75 $\pm$ 0.05
<b>P<sub>1</sub></b>	Distance Between Cavity Centers	2.0 $\pm$ 0.05
<b>P<sub>2</sub></b>	Axial Drive Distance Between Drive Hole Centers & Cavity Centers	2.0 $\pm$ 0.05
<b>P<sub>0</sub></b>	Axial Drive Distance Between Drive Hole Centers	4.0 $\pm$ 0.1
<b>D<sub>0</sub></b>	Drive Hole Diameter	1.55 $\pm$ 0.05
<b>T<sub>1</sub></b>	Top Tape Thickness	0.42 $\pm$ 0.02

NOTE: It is recommended that parts be kept in the sealed bag provided and that parts be used as soon as possible when removed from bags.